



US00D437725S

(12) **United States Design Patent**
Ishii

(10) **Patent No.:** **US D437,725 S**

(45) **Date of Patent:** **** Feb. 20, 2001**

(54) **HOLDING CASE FOR DISC TRAY**

(75) Inventor: **Hirohisa Ishii**, Tokyo (JP)

(73) Assignees: **Sony Corporation; Start Lab Inc.**,
both of Tokyo (JP)

(**) Term: **14 Years**

(21) Appl. No.: **29/119,581**

(22) Filed: **Feb. 29, 2000**

(30) **Foreign Application Priority Data**

Sep. 1, 1999 (JP) D11-023572

(51) **LOC (7) Cl.** **06-04**

(52) **U.S. Cl.** **D6/634; D6/407; D6/632;**
D6/635

(58) **Field of Search** D3/201; D6/407,
D6/408, 626-635, 124; D14/26, 27; D19/32,
33, 74, 89, 75, 76; D27/340, 360; 40/626,
771, 775, 307; 150/149; 132/312; 206/307,
308.1, 308.3, 309, 311, 312, 313, 387.13,
396, 408, 730; 229/67.1, 68.1, 70-72

(56) **References Cited**

U.S. PATENT DOCUMENTS

- D. 222,012 * 9/1971 Harris D6/633
- D. 256,737 * 9/1980 Woodhall D6/631
- D. 262,752 * 1/1982 Pepicelli, Jr. et al. D6/633
- D. 266,883 * 11/1982 Akeret D6/628
- D. 272,869 * 3/1984 Davis D3/282
- D. 287,426 * 12/1986 Godfrey D6/631
- D. 317,079 * 5/1991 Schmidt et al. D6/631

- D. 320,886 * 10/1991 Melk D6/633
- D. 335,574 * 5/1993 Roskvist et al. D6/634
- D. 337,652 * 7/1993 Vierra D6/633
- D. 348,903 * 7/1994 Fischtein et al. D19/76
- D. 358,055 * 5/1995 Long et al. D6/632
- D. 421,856 * 3/2000 Kirihara et al. D6/407
- D. 423,772 * 5/2000 Cooper et al. D3/218
- 4,164,309 * 8/1979 Staats 206/425
- 5,235,822 * 8/1993 Leonovich, Jr. 62/457.2

* cited by examiner

Primary Examiner—Celia Murphy

(74) *Attorney, Agent, or Firm*—Jay H. Maioli

(57) **CLAIM**

The ornamental design for a holding case for disc tray, as shown and described.

DESCRIPTION

FIG. 1 is a top, front, and right-side perspective view of a holding case for disc tray, showing my new design;
 FIG. 2 is a front elevational view thereof, the rear being a mirror image thereof;
 FIG. 3 is a right-side elevational view thereof, the left-side being a mirror image thereof;
 FIG. 4 is a top plan view thereof;
 FIG. 5 is a bottom plan view thereof;
 FIG. 6 is a top, front and right-side perspective view thereof shown with one door in an open position; and,
 FIG. 7 is a right-side elevational view thereof shown with both doors in the open position.
 Any unshown portions of the inner surface are not part of the claimed design.

1 Claim, 4 Drawing Sheets

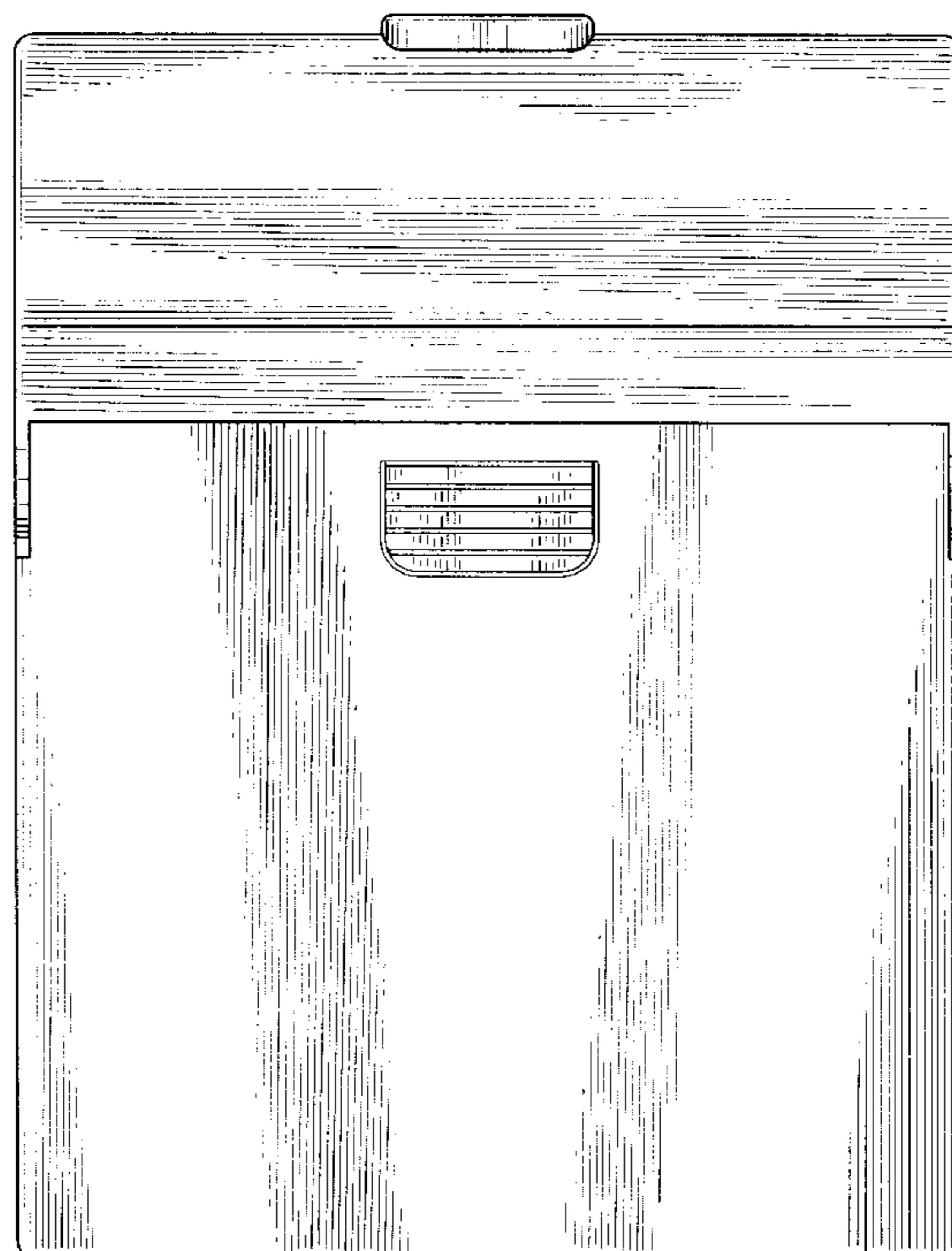

FIG.2

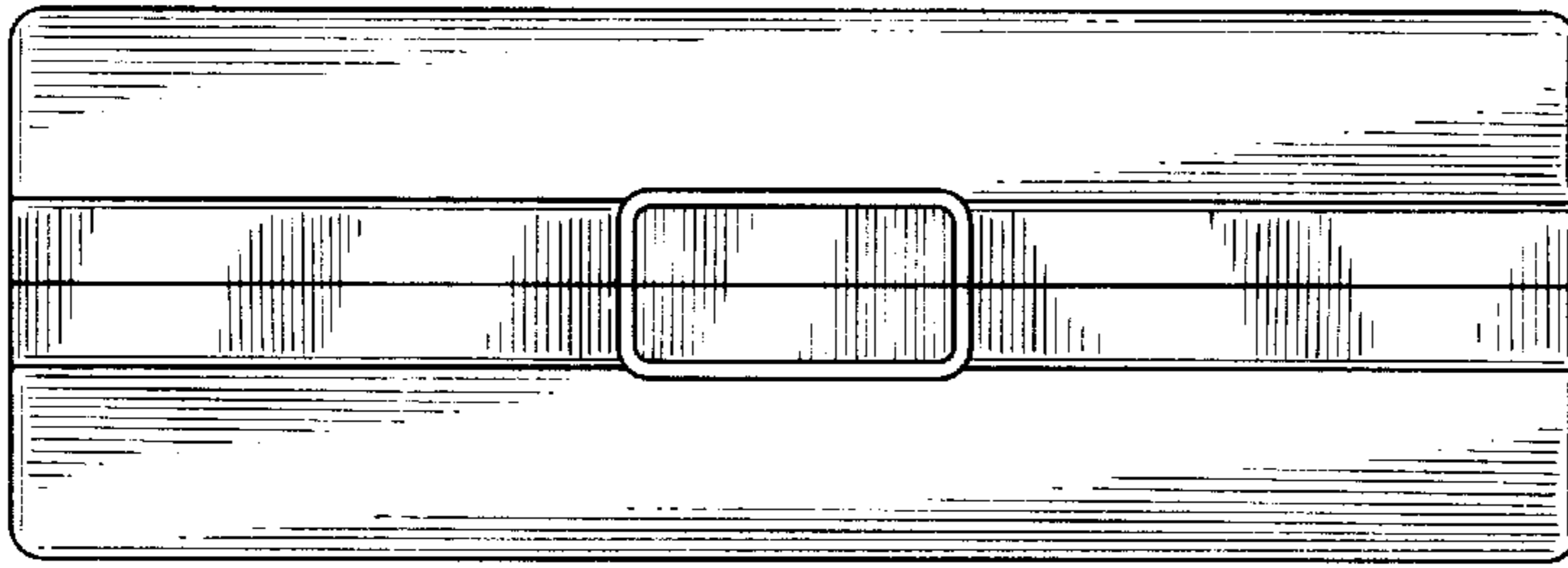

FIG.1

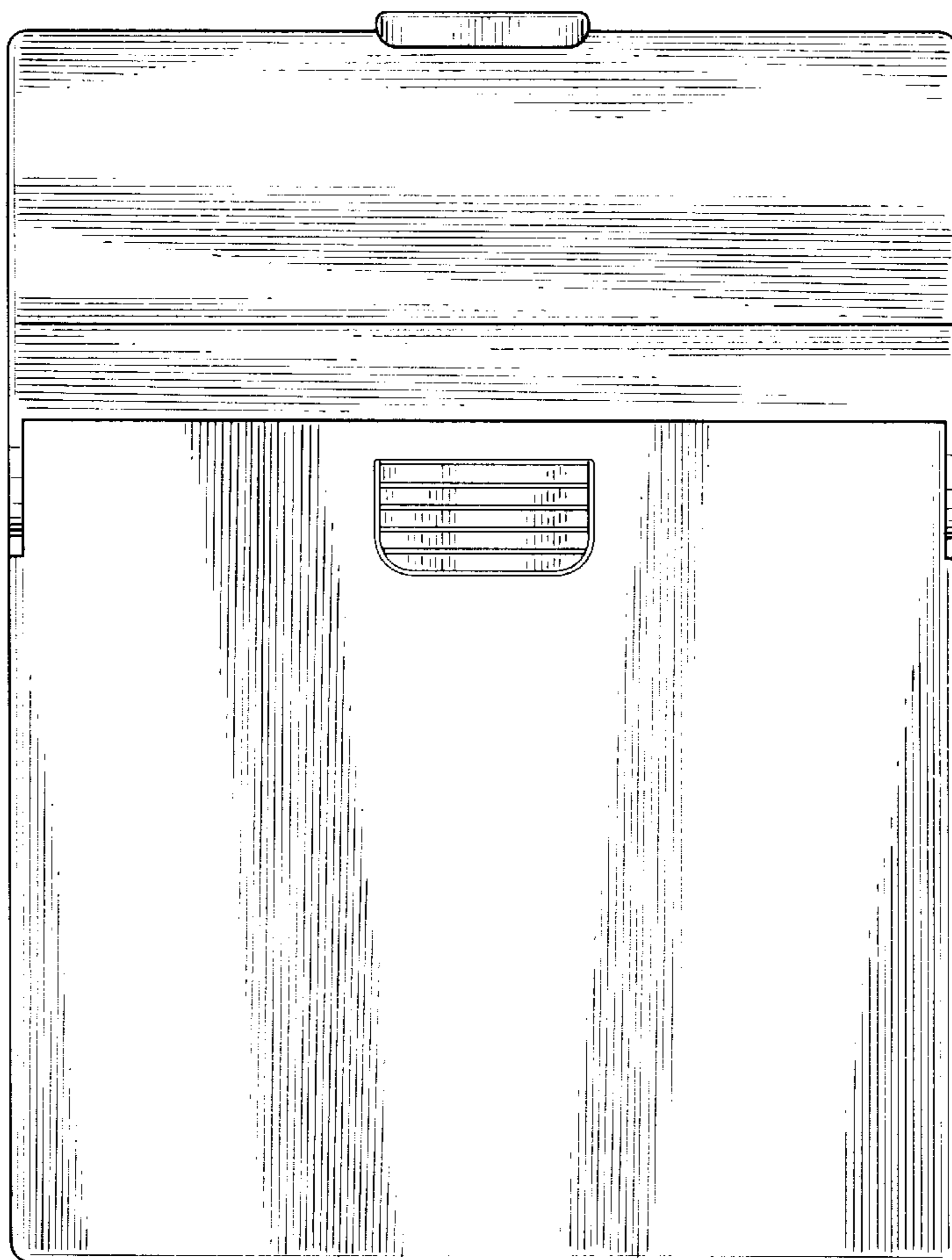

FIG.4

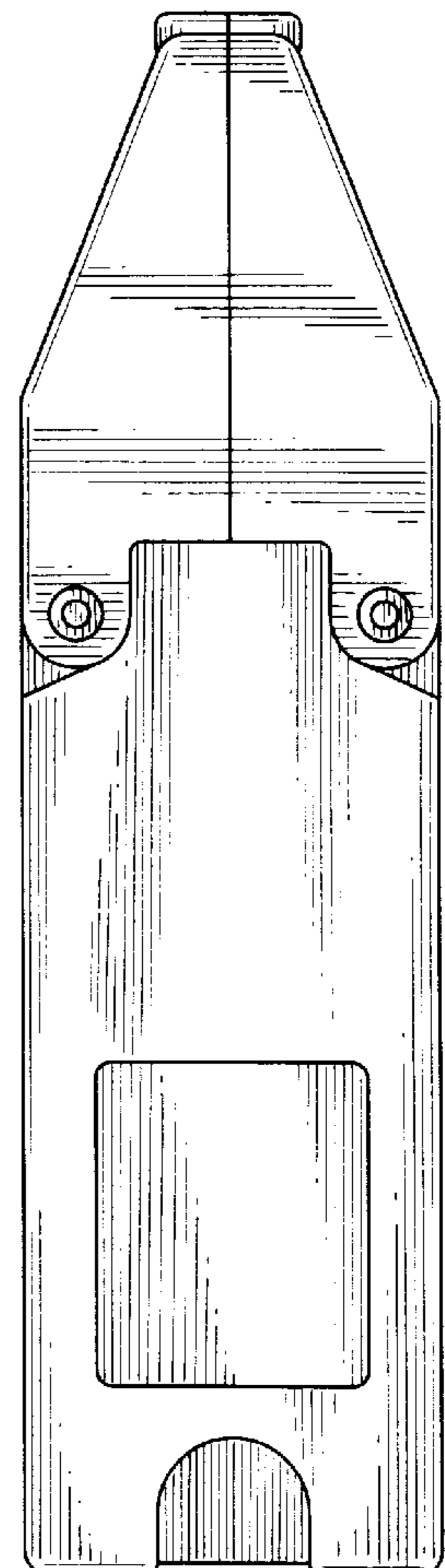

FIG.3

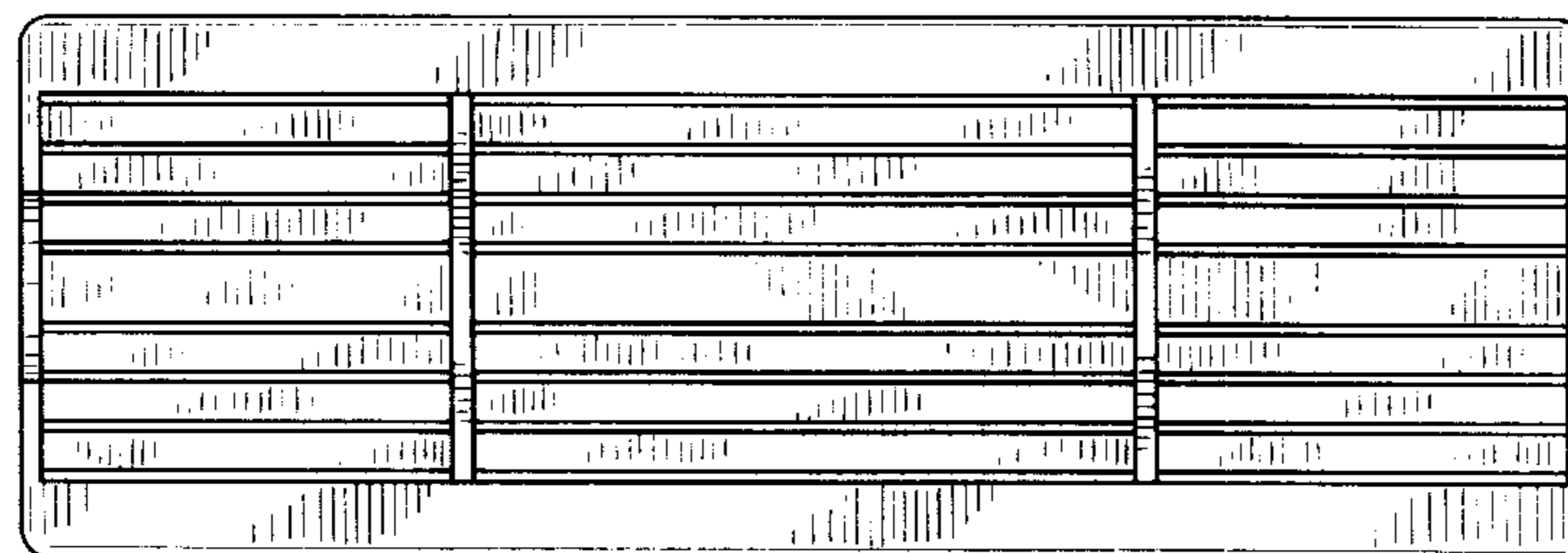

FIG.5

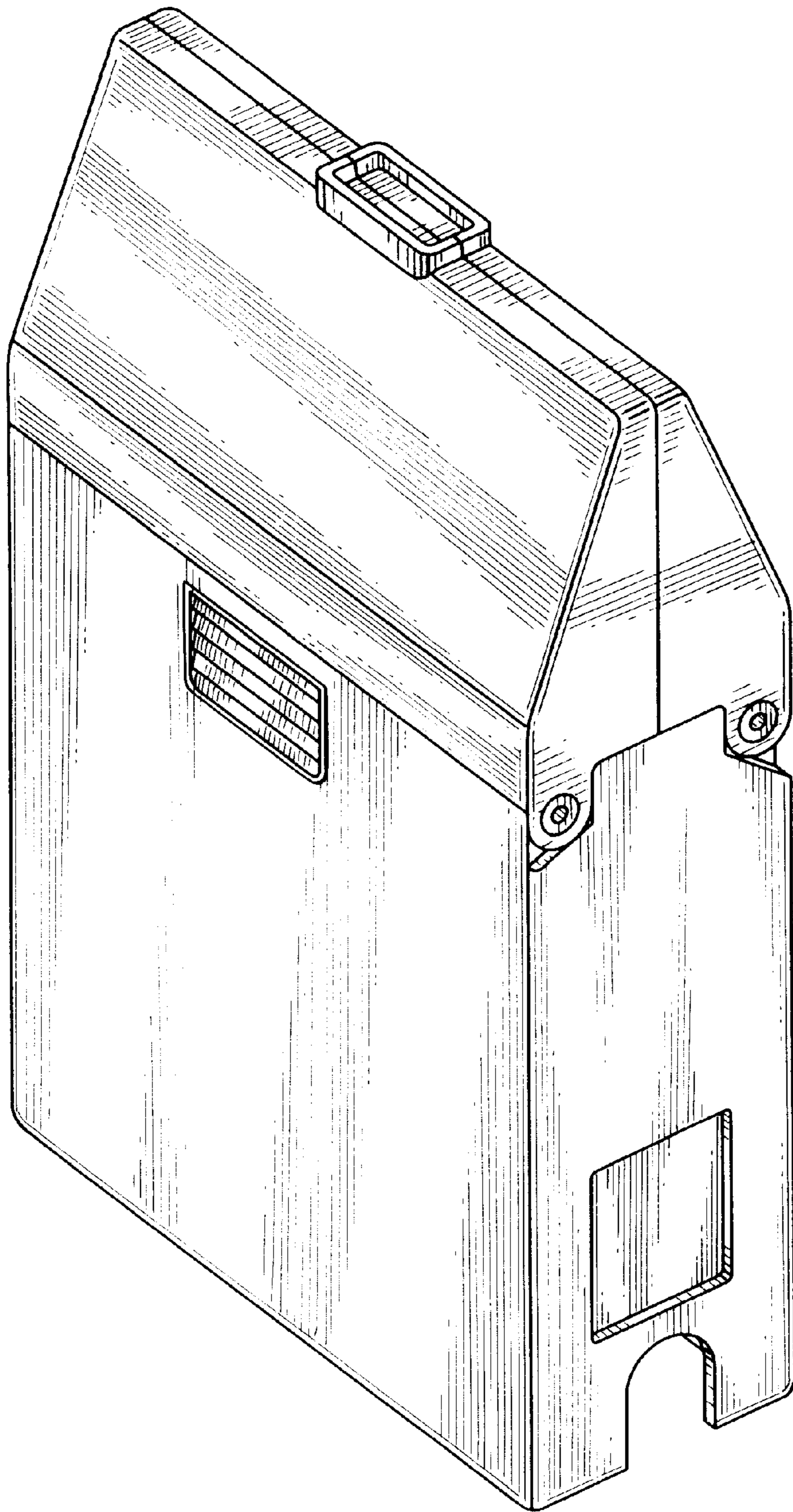

FIG.6

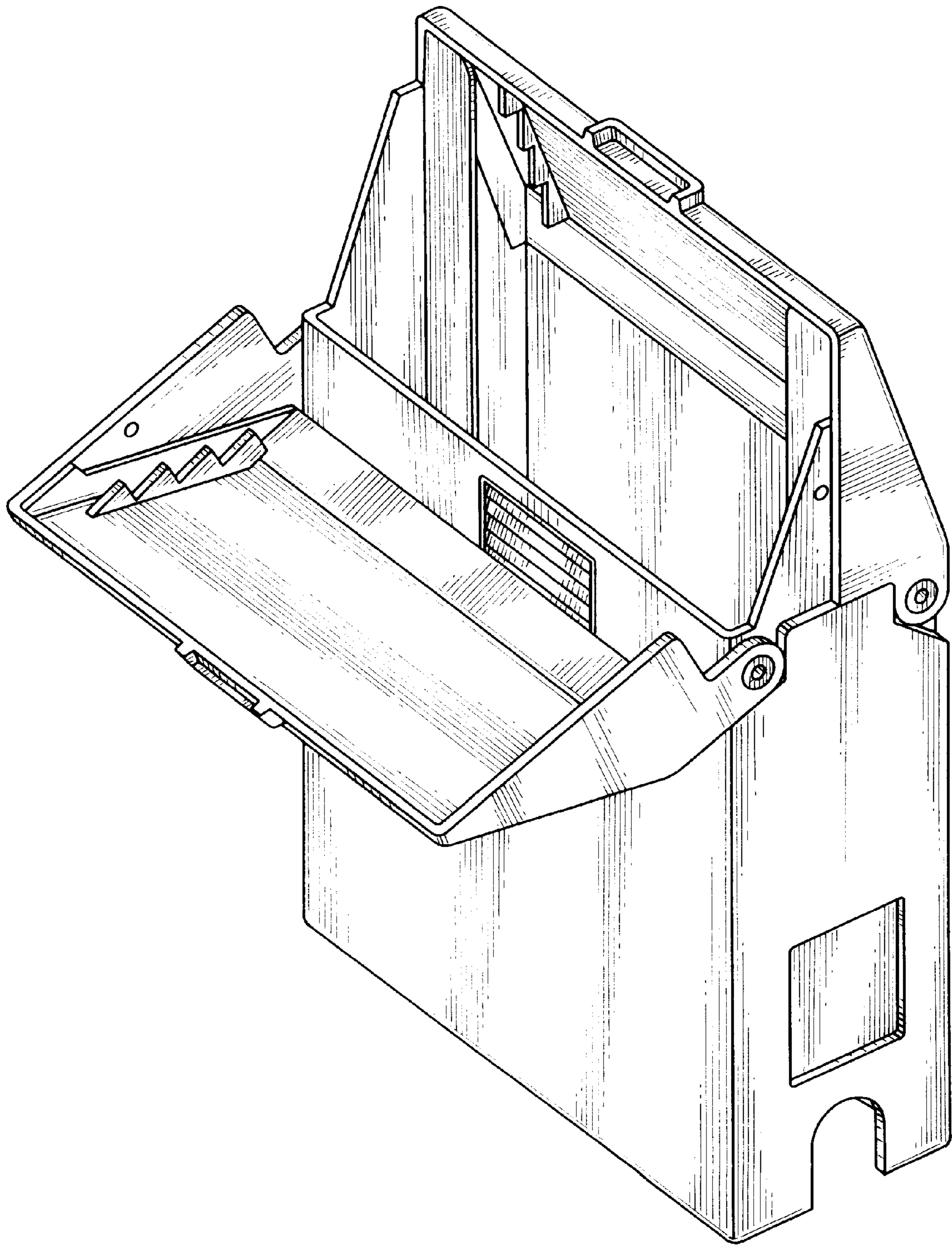

FIG.7

