



US00D437698S

(12) **United States Design Patent**  
**Cassler**

(10) **Patent No.:** **US D437,698 S**

(45) **Date of Patent:** **\*\* Feb. 20, 2001**

(54) **COMBINATION PURSE AND COAT HOLDER**

(76) Inventor: **Kathleen A. Cassler**, 10314 Lackland Rd., St. Louis, MO (US) 63114

(\*\*) Term: **14 Years**

(21) Appl. No.: **29/099,662**

(22) Filed: **Jan. 26, 1999**

(51) **LOC (7) Cl.** ..... **06-08**

(52) **U.S. Cl.** ..... **D6/323**

(58) **Field of Search** ..... D6/553, 552, 567,  
D6/315, 320, 323; 211/13.1, 71, 30, 32,  
85.3, 88, 126.1; 248/309.1, 311.2

(56) **References Cited**

**U.S. PATENT DOCUMENTS**

|            |   |         |                |       |             |
|------------|---|---------|----------------|-------|-------------|
| D. 356,461 | * | 3/1995  | May et al.     | ..... | D6/567      |
| D. 390,013 | * | 2/1998  | Ho             | ..... | D6/323      |
| D. 399,692 | * | 10/1998 | Wilcox         | ..... | D6/567      |
| 4,828,121  | * | 5/1989  | Willcocks, Jr. | ..... | 211/126.1 X |

\* cited by examiner

*Primary Examiner*—Brian N. Vinson

(74) *Attorney, Agent, or Firm*—Polster, Lieder, Woodruff & Lucchesi, L.C.

(57) **CLAIM**

I claim the ornamental design for a combination purse and coat holder, as shown.

**DESCRIPTION**

FIG. 1 is a top, front and left side perspective view of a combination purse and coat holder showing a first embodiment of my new design;

FIG. 2 is a front elevational view thereof;

FIG. 3 is a rear elevational view thereof;

FIG. 4 is a right side elevational view thereof;

FIG. 5 is top plan view thereof;

FIG. 6 is a bottom plan view thereof;

FIG. 7 is a top, front and left side perspective view of a combination purse and coat holder showing a second embodiment of my new design;

FIG. 8 is a front elevational view thereof;

FIG. 9 is a rear elevational view thereof;

FIG. 10 is a right side elevational view thereof;

FIG. 11 is top plan view thereof; and,

FIG. 12 is a bottom plan view thereof.

**1 Claim, 3 Drawing Sheets**

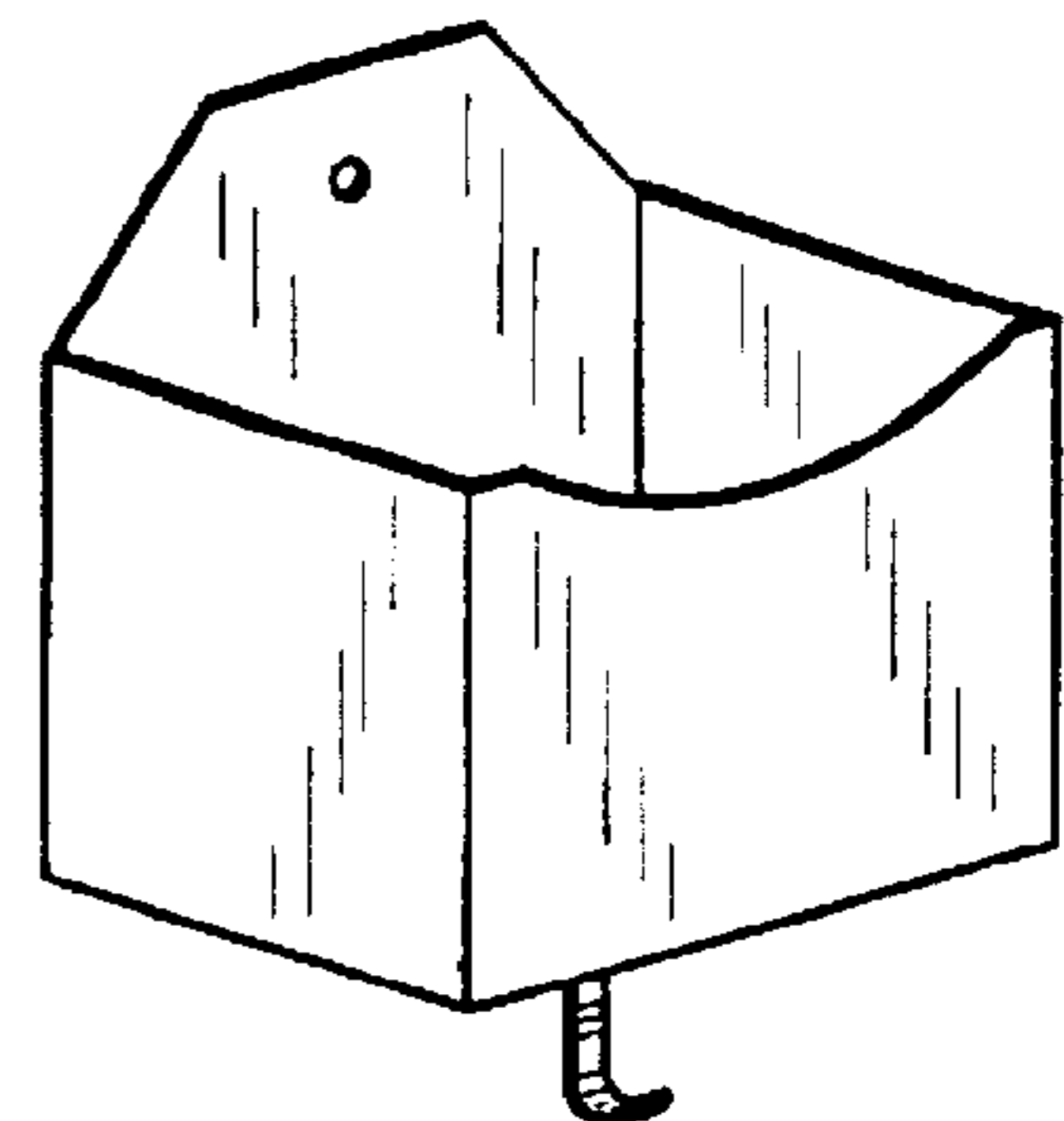
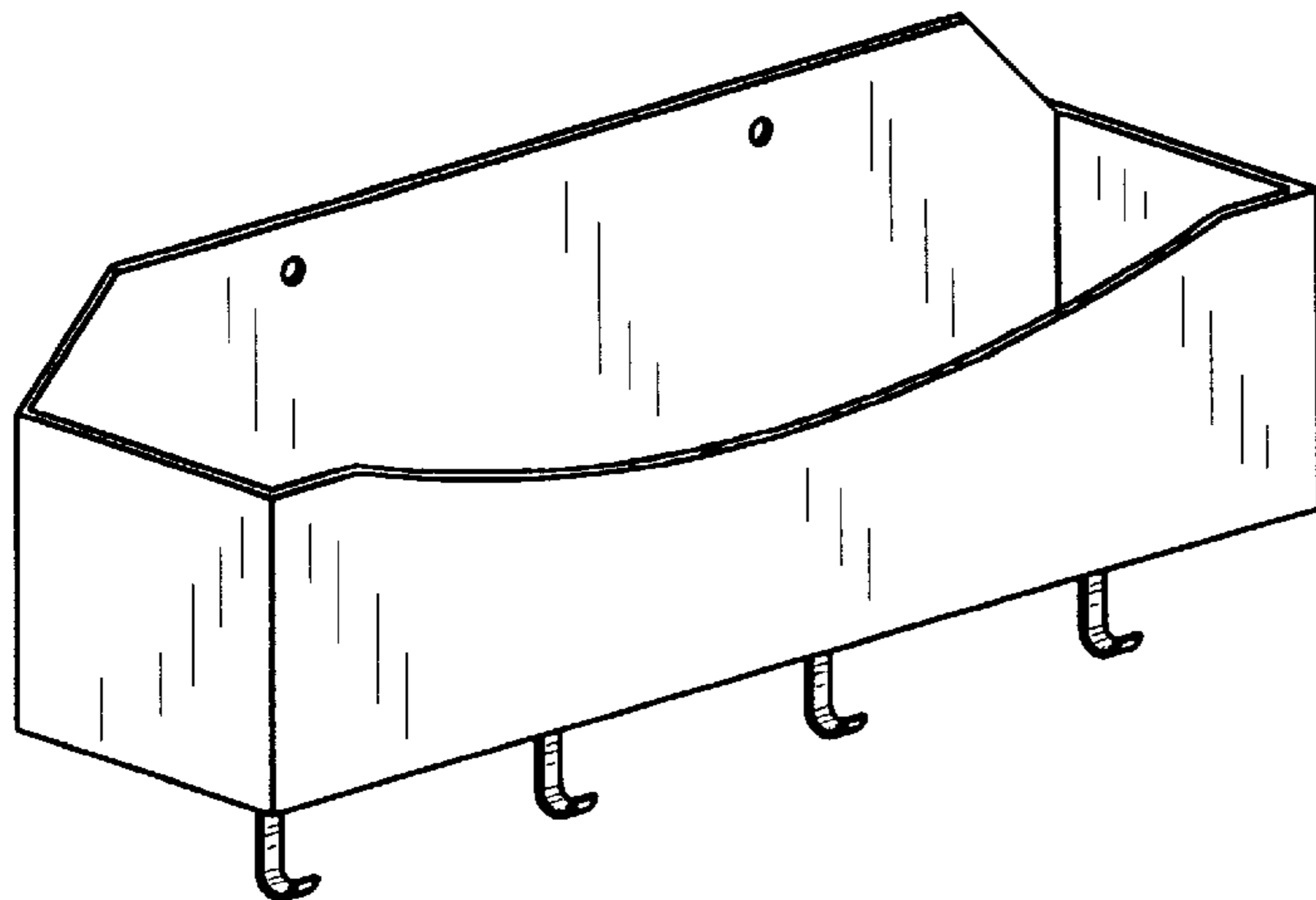

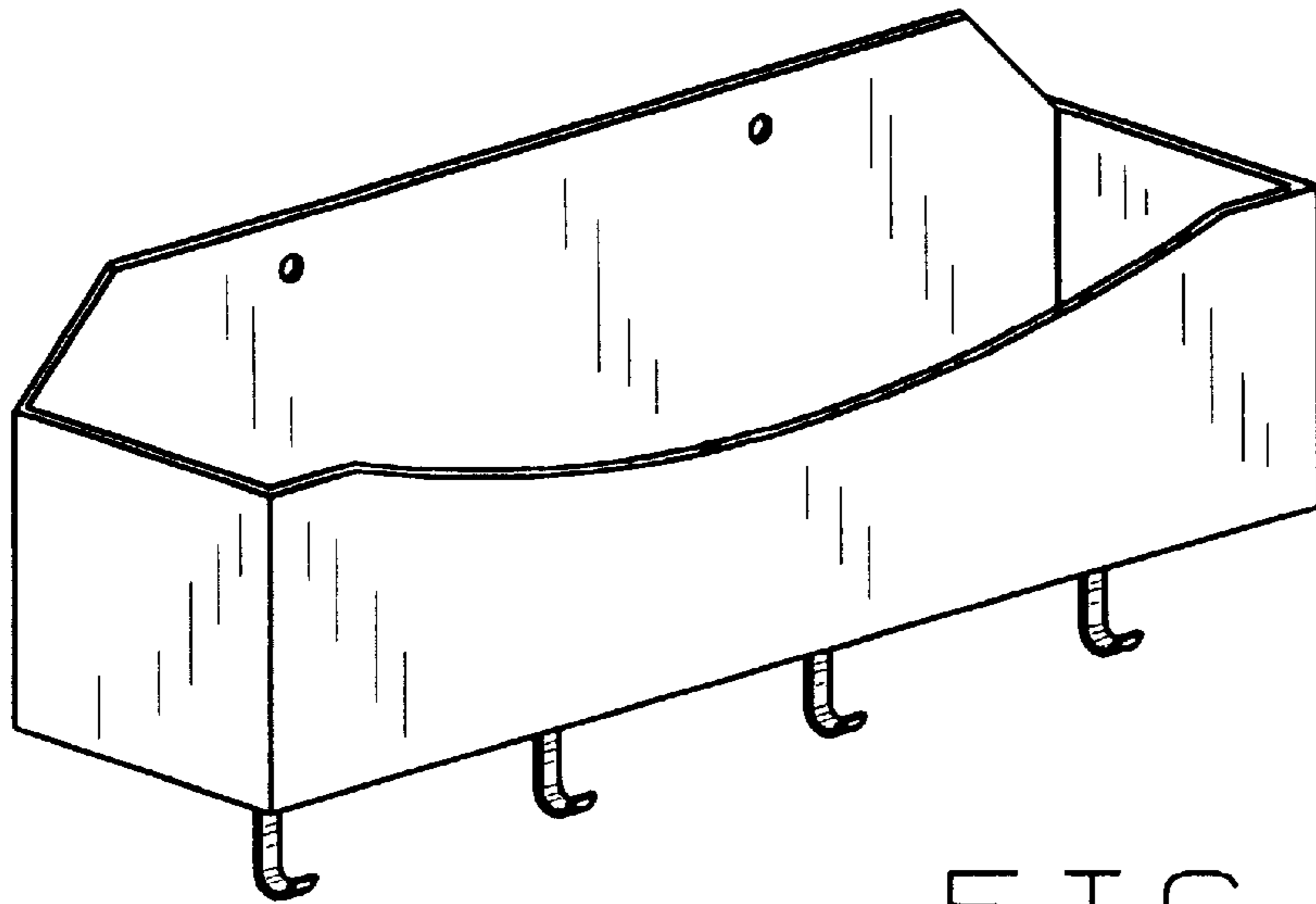

FIG. 1

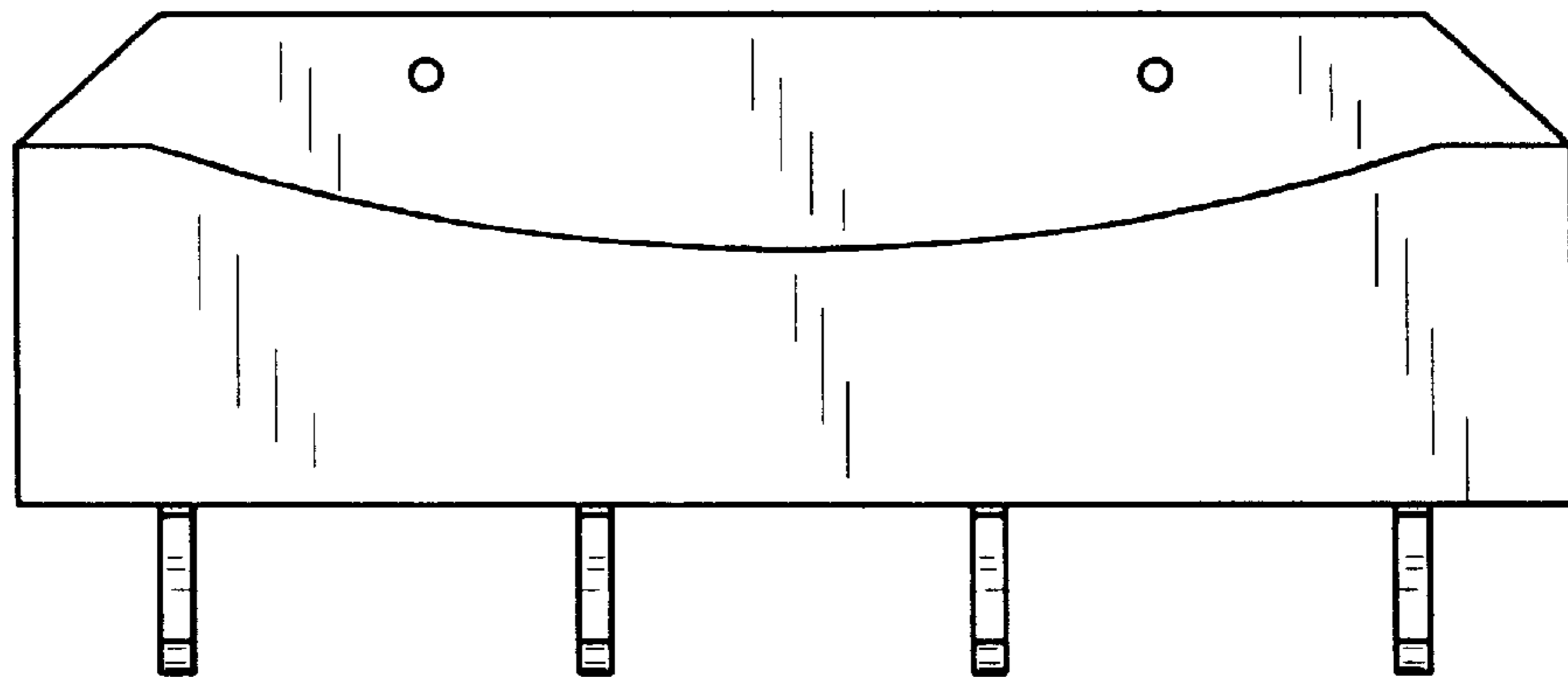

FIG. 2

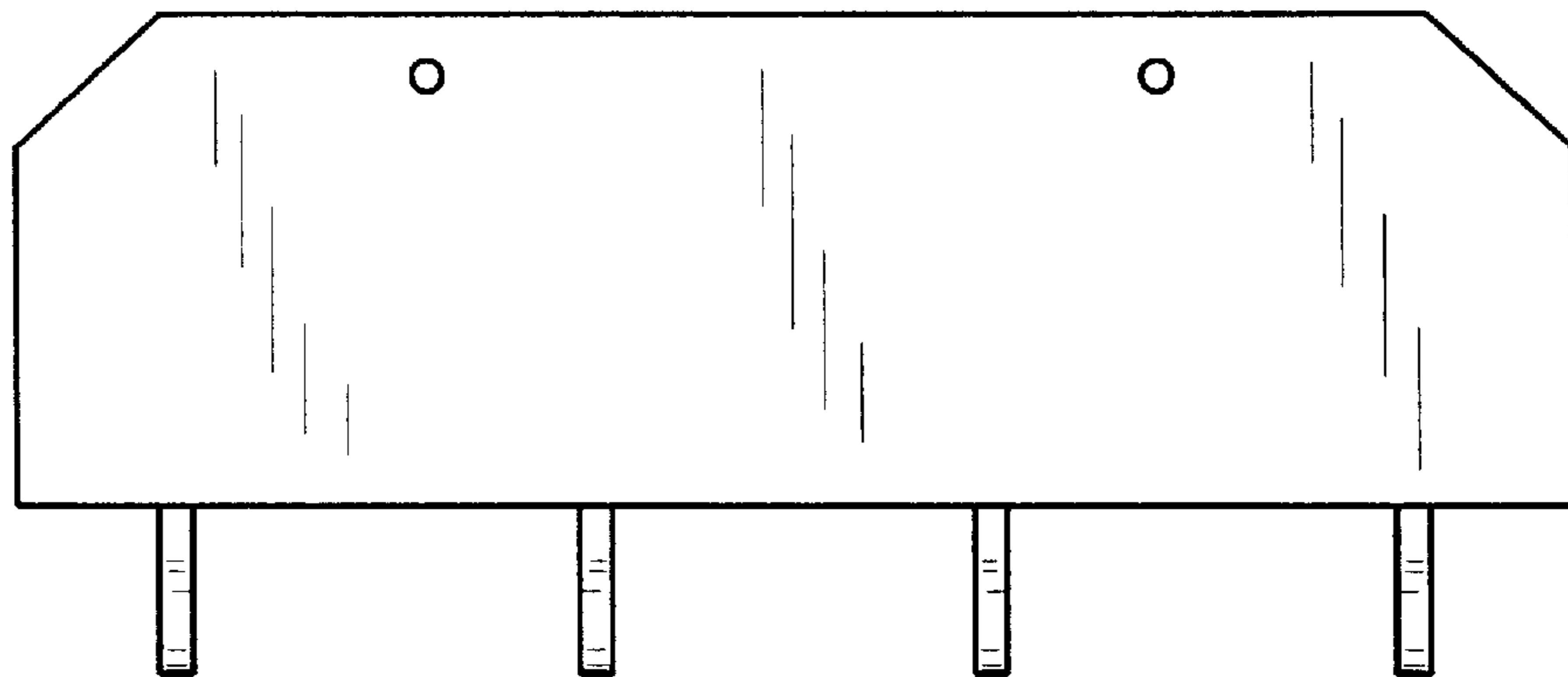

FIG. 3

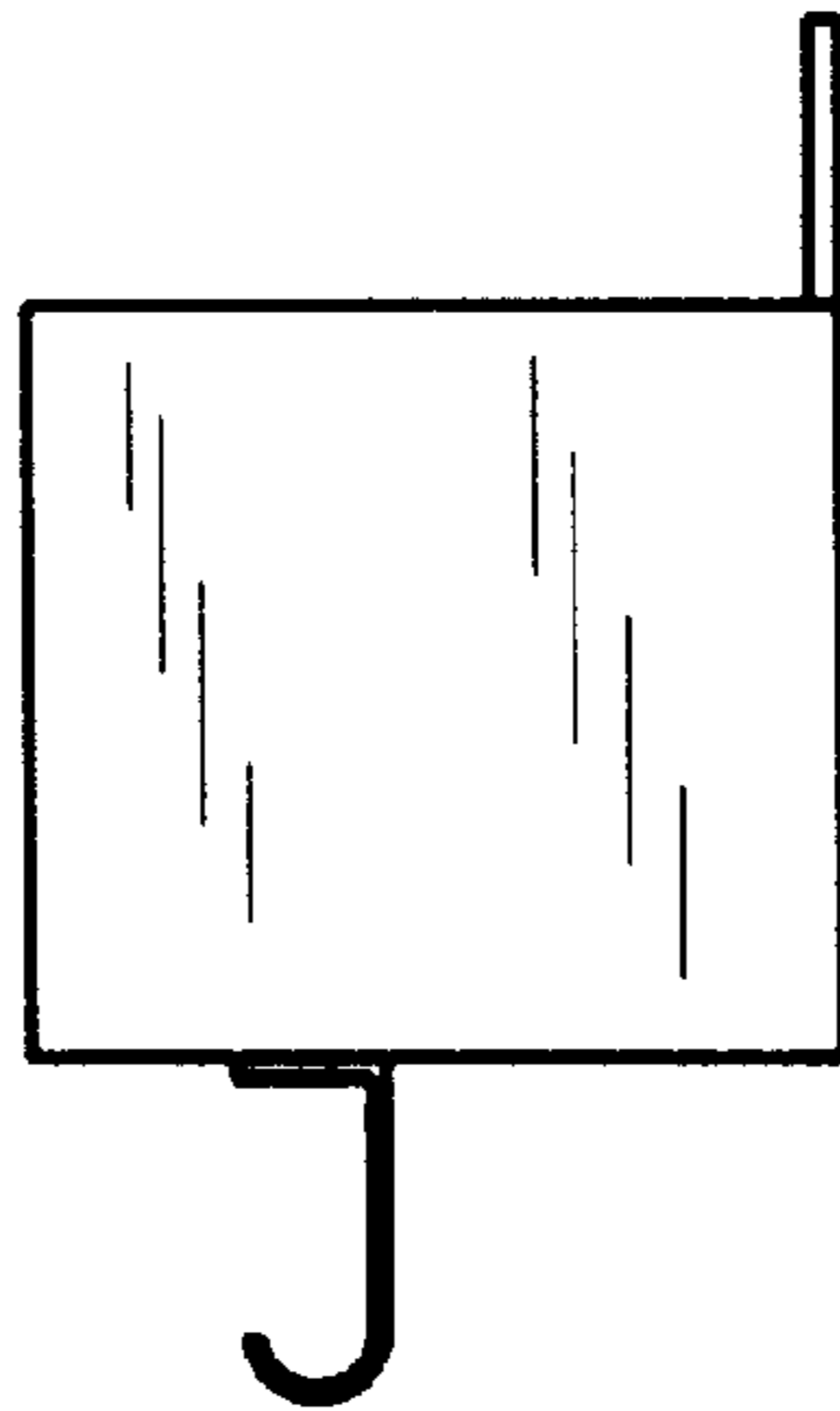

FIG. 4

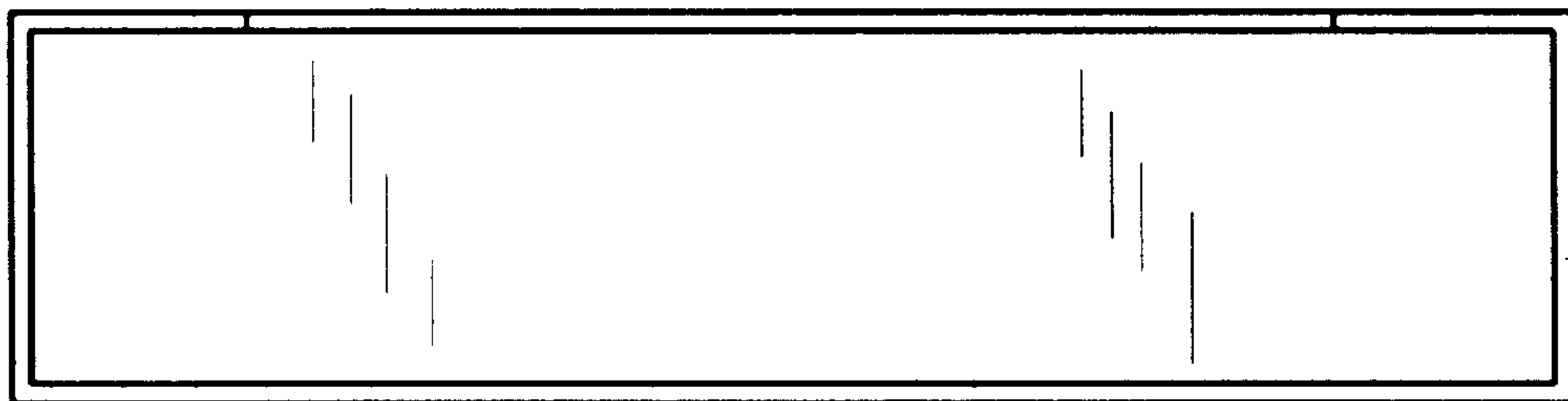

FIG. 5

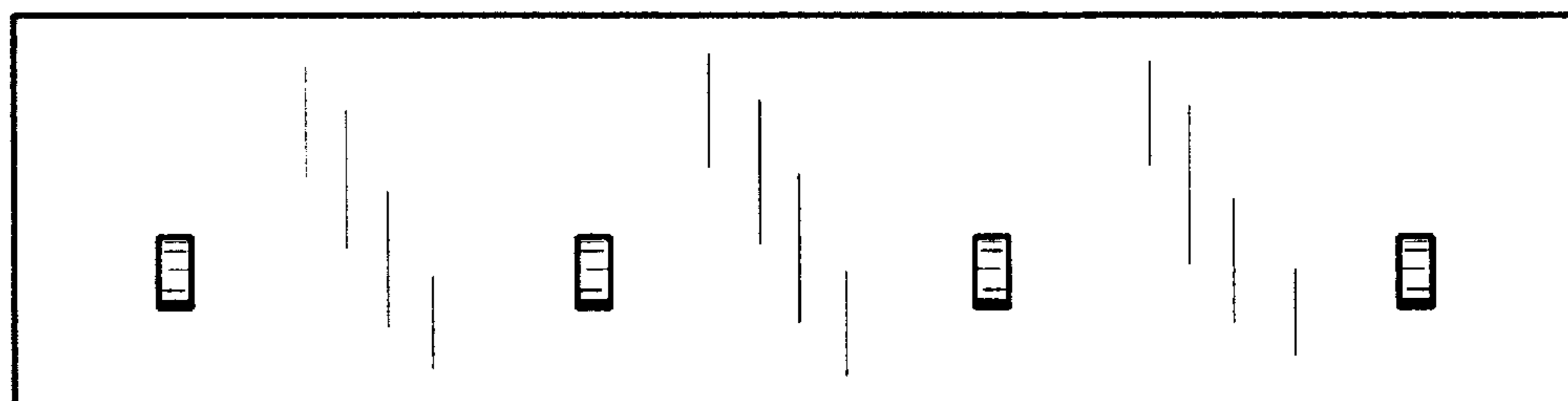

FIG. 6

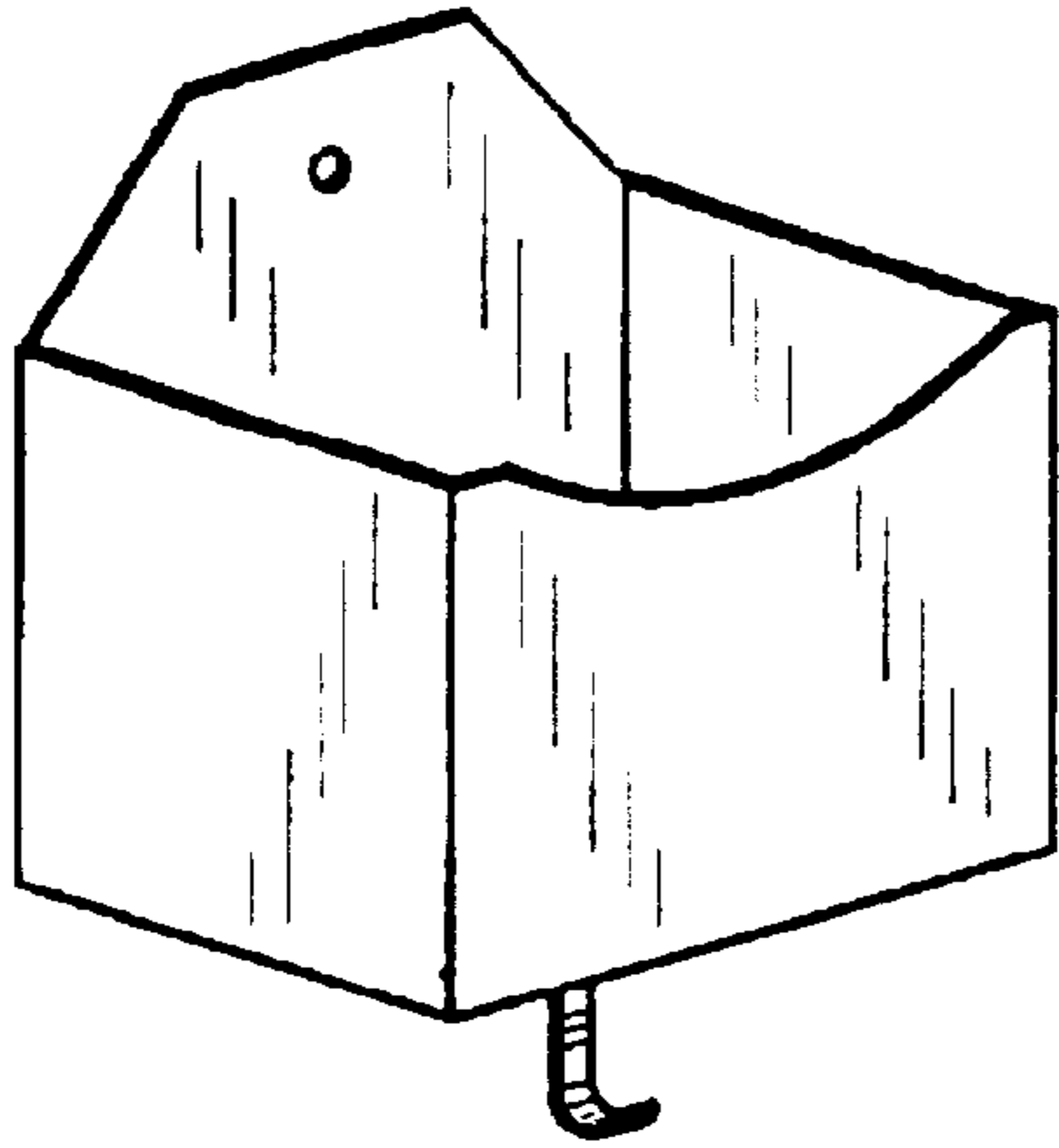

FIG. 7

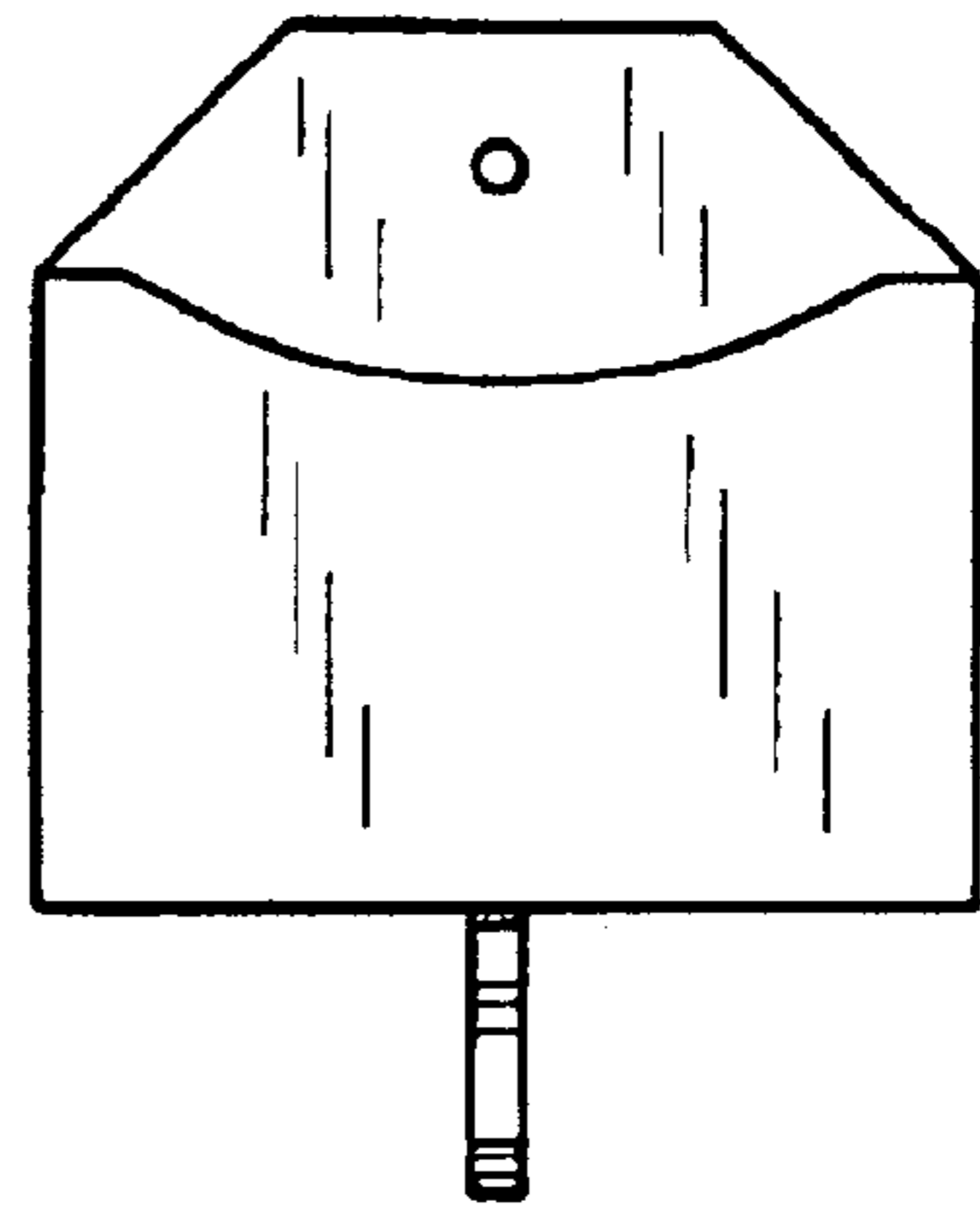

FIG. 8

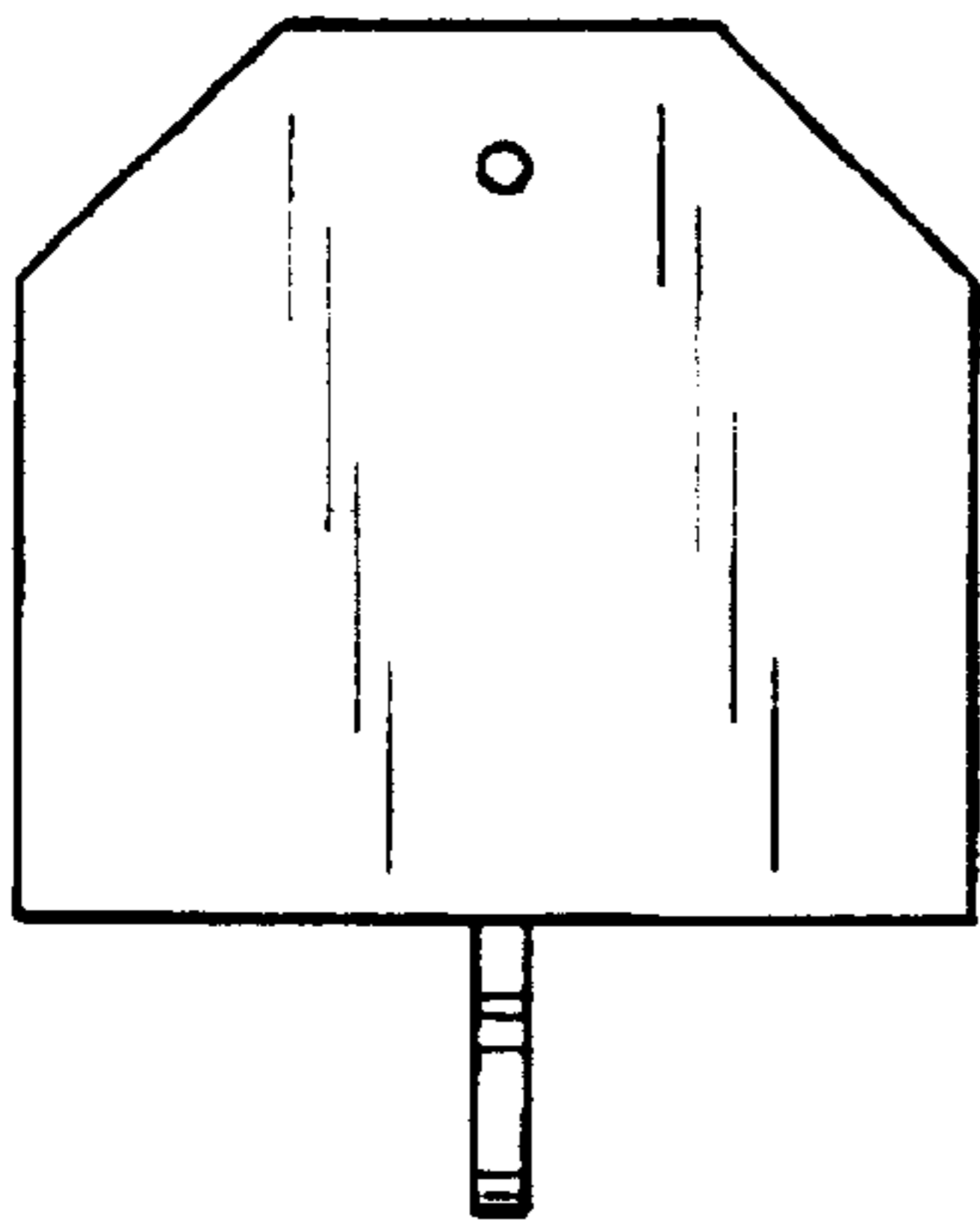

FIG. 9

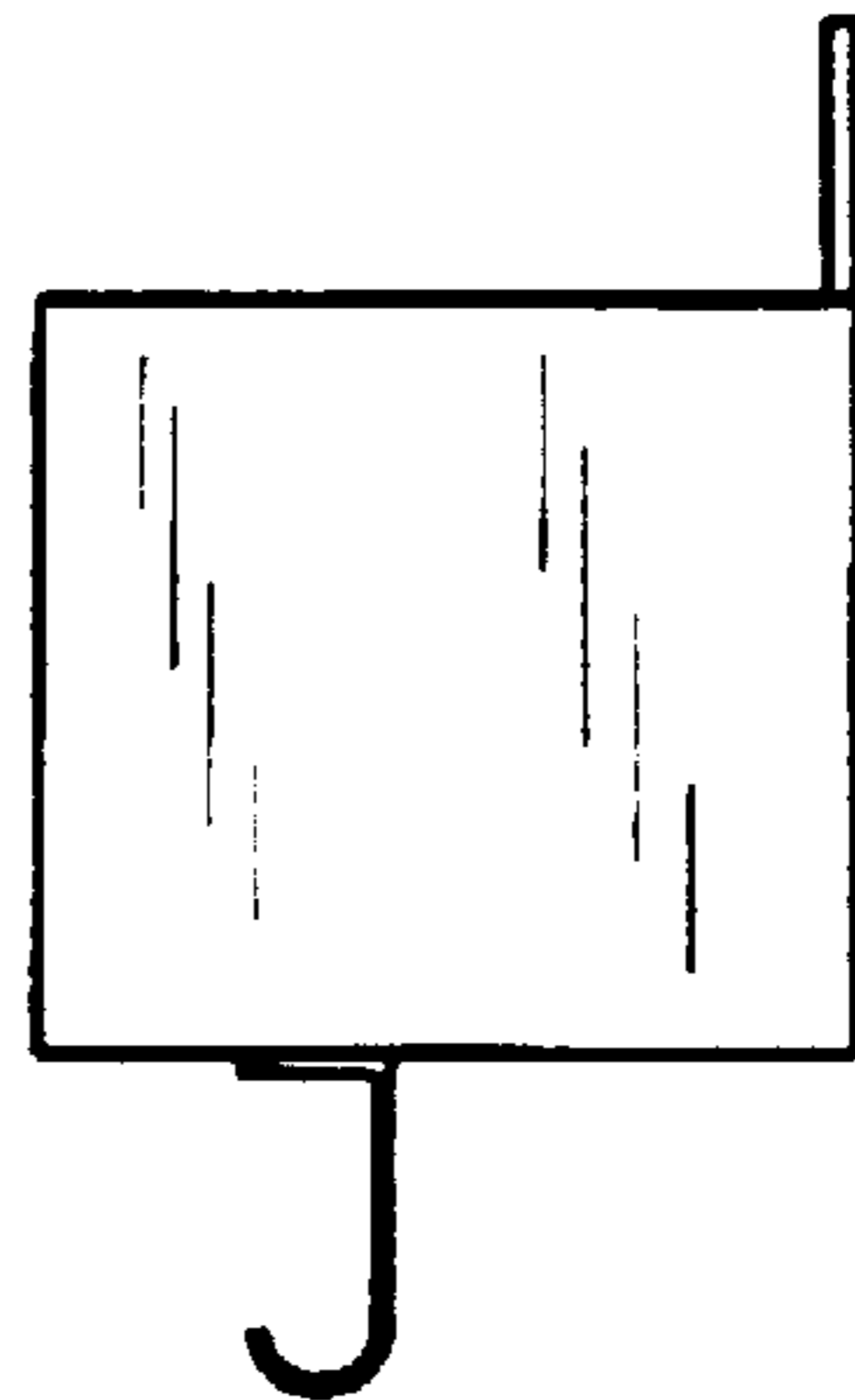

FIG. 10

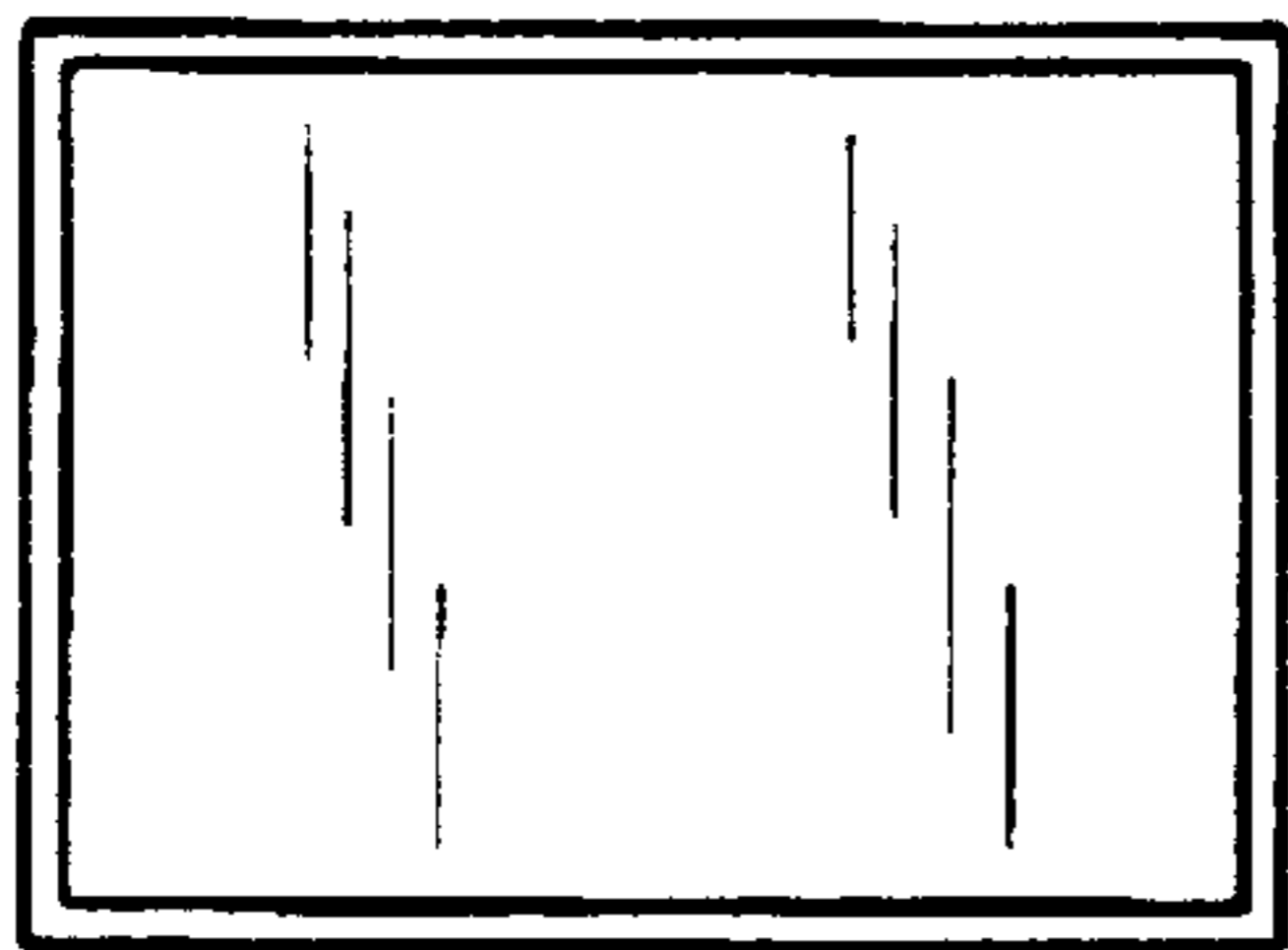

FIG. 11

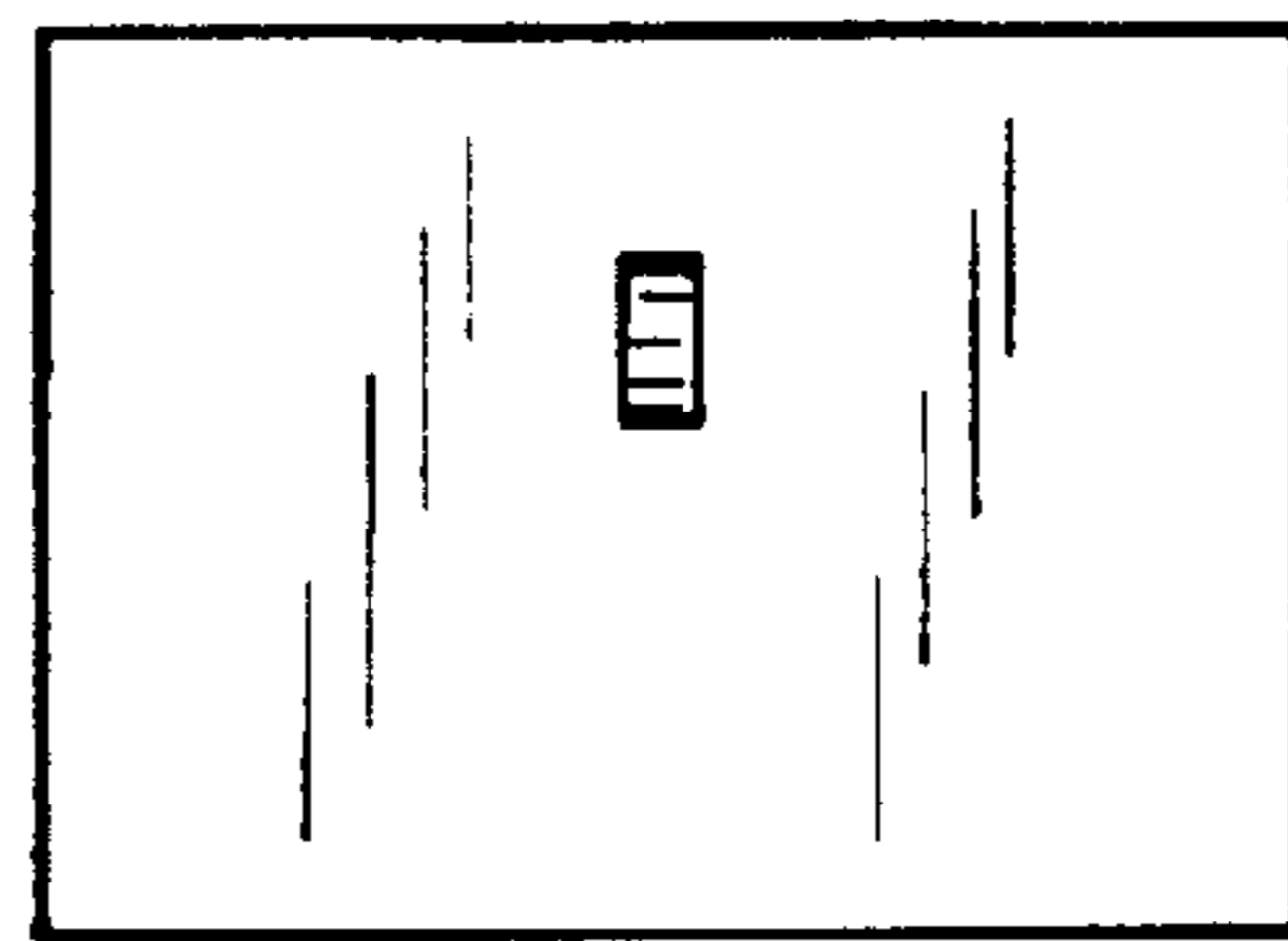

FIG. 12