



US00D437518S

(12) **United States Design Patent**
Andersson

(10) **Patent No.:** **US D437,518 S**

(45) **Date of Patent:** **** Feb. 13, 2001**

(54) **PAPER DISPENSER**

(75) Inventor: **Jerker Andersson, Göteborg (SE)**

(73) Assignee: **SCA Hygiene Products AB,**
Gothenburg (SE)

(**) Term: **14 Years**

(21) Appl. No.: **29/114,420**

(22) Filed: **Nov. 24, 1999**

(30) **Foreign Application Priority Data**

May 26, 1999 (SE) 99-0940
May 26, 1999 (SE) 99-0946

(51) **LOC (7) Cl.** **20-02**

(52) **U.S. Cl.** **D6/518; D6/522**

(58) **Field of Search** D6/515, 518, 521,
D6/522, 523; 206/389, 824; 221/26, 33,
282, 283; 242/570; 312/34.1, 34.4, 34.8

(56) **References Cited**

U.S. PATENT DOCUMENTS

- D. 310,759 * 9/1990 Breger D6/523
- D. 316,788 * 5/1991 Fischer et al. D6/522
- D. 346,519 * 5/1994 Krueger et al. D6/522
- D. 373,277 * 9/1996 Giugiaro D6/522
- D. 385,445 * 10/1997 Arbak et al. D6/522
- D. 398,797 * 9/1998 Brandenburg et al. D6/522

- D. 416,725 * 11/1999 Lewis D6/522
- D. 426,412 * 6/2000 Cameron D6/522
- 5,772,291 * 6/1998 Byrd et al. 312/34.8 X
- 5,868,275 * 2/1999 Moody 221/33

* cited by examiner

Primary Examiner—Brian N. Vinson

(74) *Attorney, Agent, or Firm*—Burns, Doane, Swecker & Mathis, L.L.P.

(57) **CLAIM**

The ornamental design for a paper dispenser, as shown and described.

DESCRIPTION

FIG. 1 is a front, side perspective view of a paper dispenser showing my new design;

FIG. 2 is a front, side perspective view thereof, with the casing portion being shown in an open position;

FIG. 3 is a rear perspective view of the casing portion of the paper dispenser shown in FIG. 1, with the wall mounting portion being removed for clarity;

FIG. 4 is a front, side perspective view of the wall mounting portion of the paper dispenser shown in FIG. 1, with the casing portion being removed for clarity;

FIG. 5 is a top perspective view thereof;

FIG. 6 is a rear perspective view thereof; and,

FIG. 7 is a bottom perspective view thereof.

1 Claim, 3 Drawing Sheets

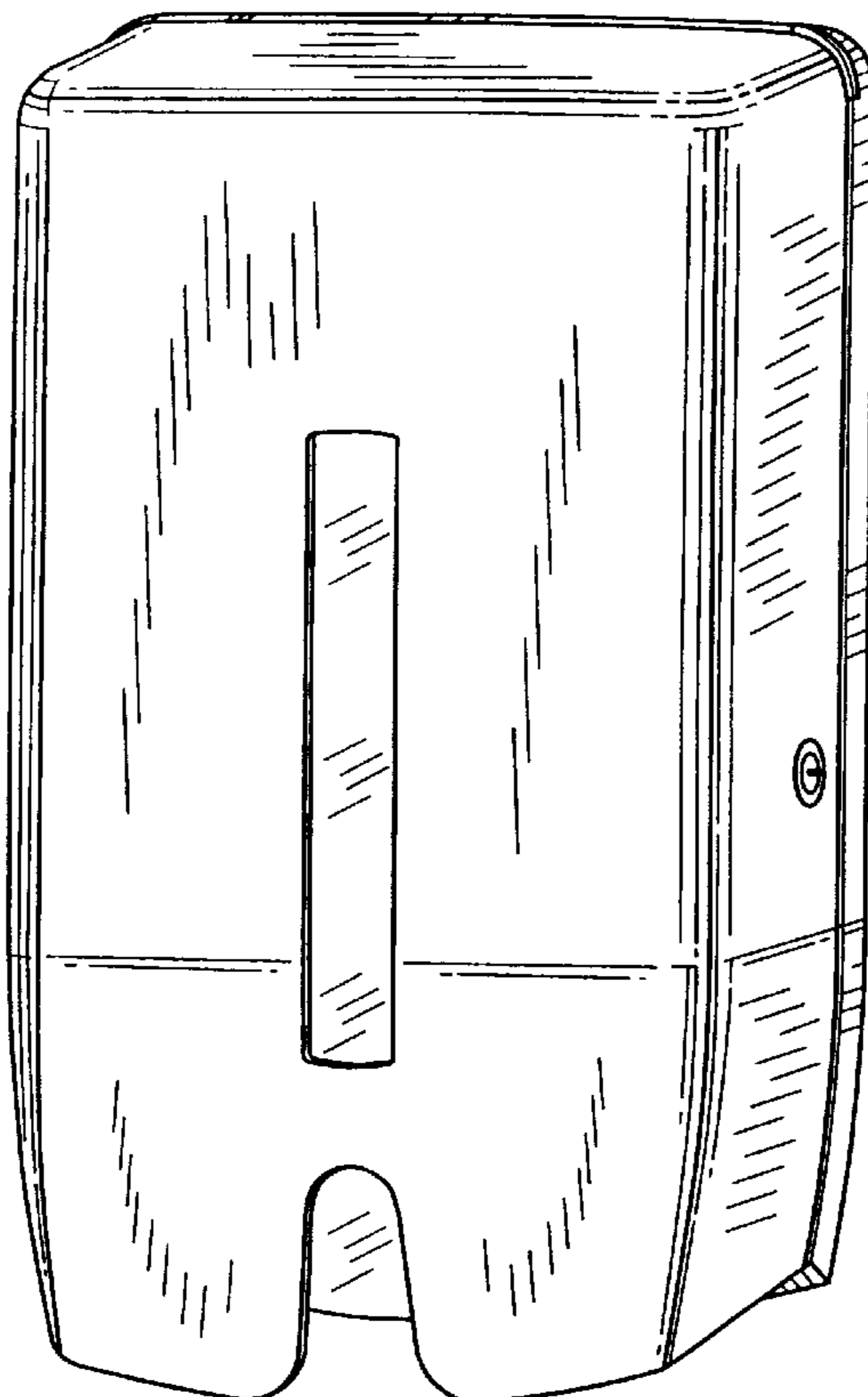

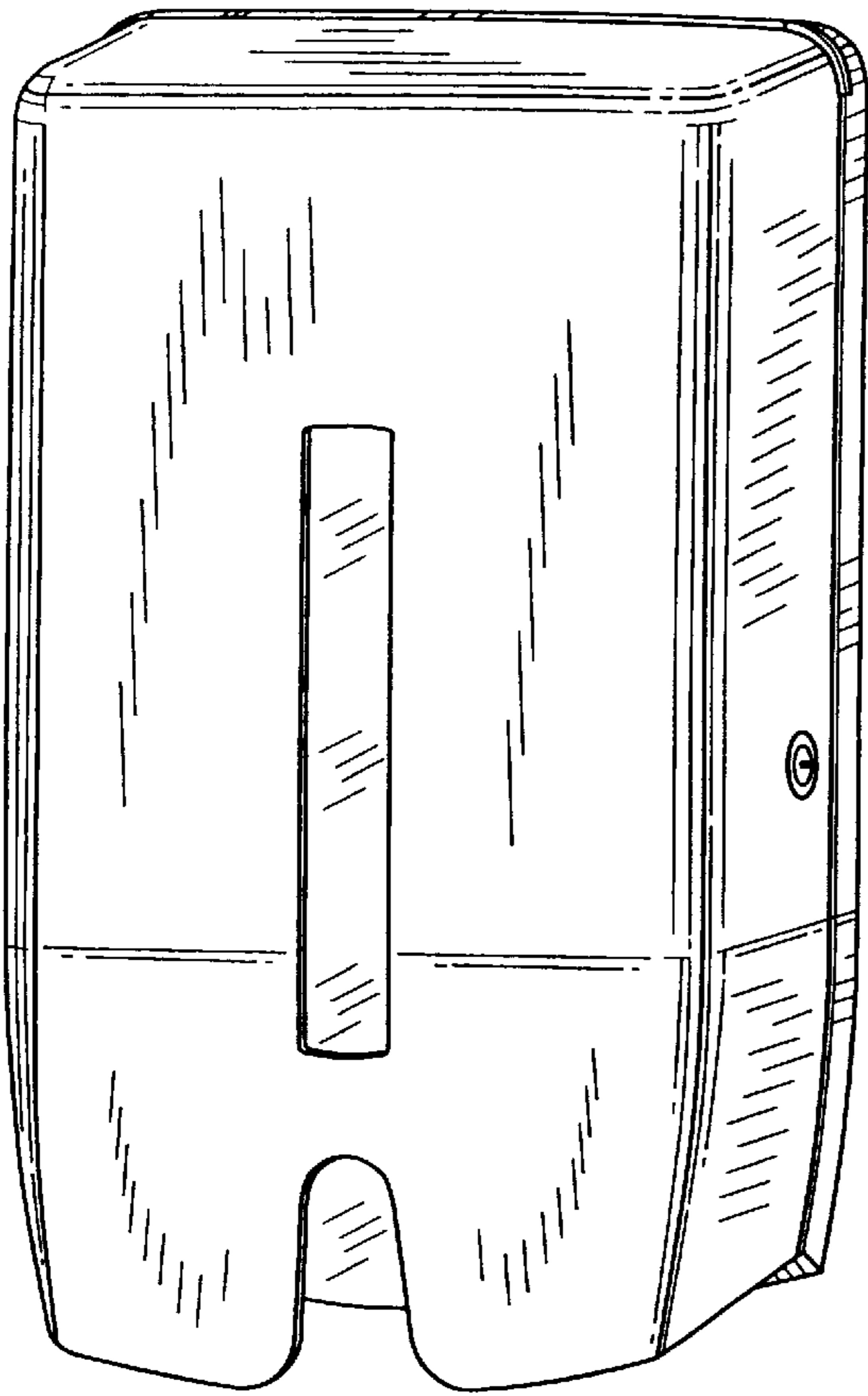

FIG. 1

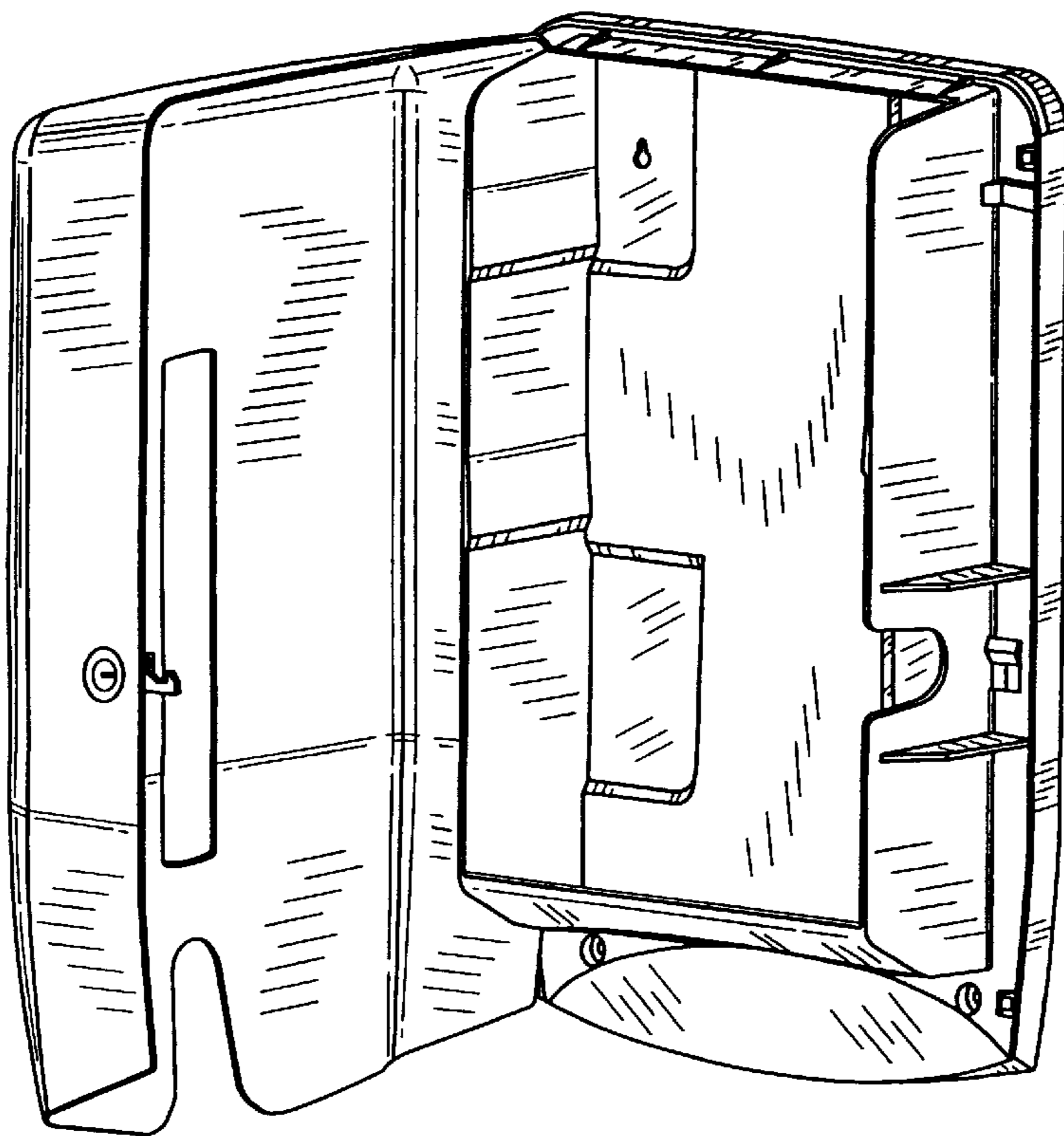

FIG. 2

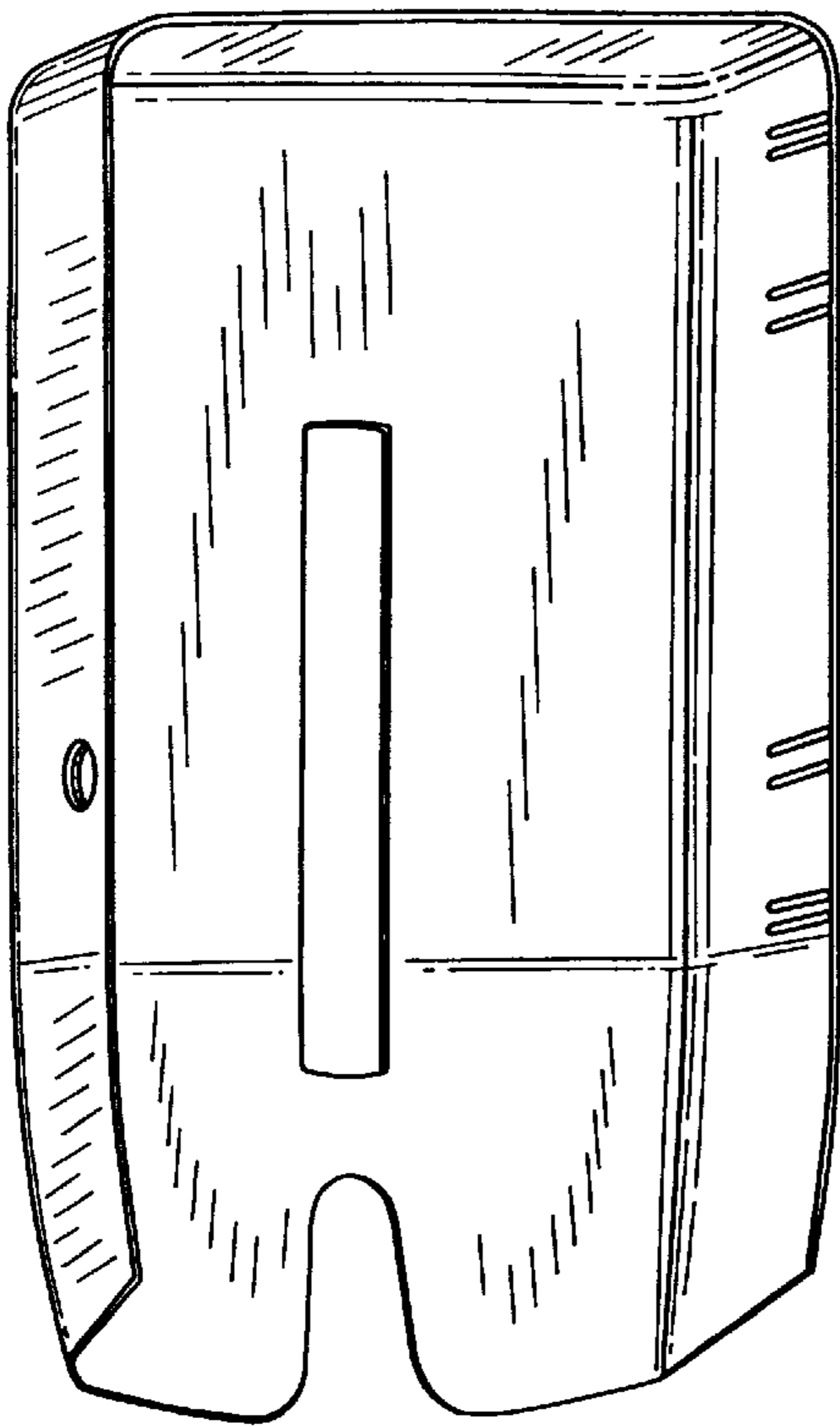

FIG. 3

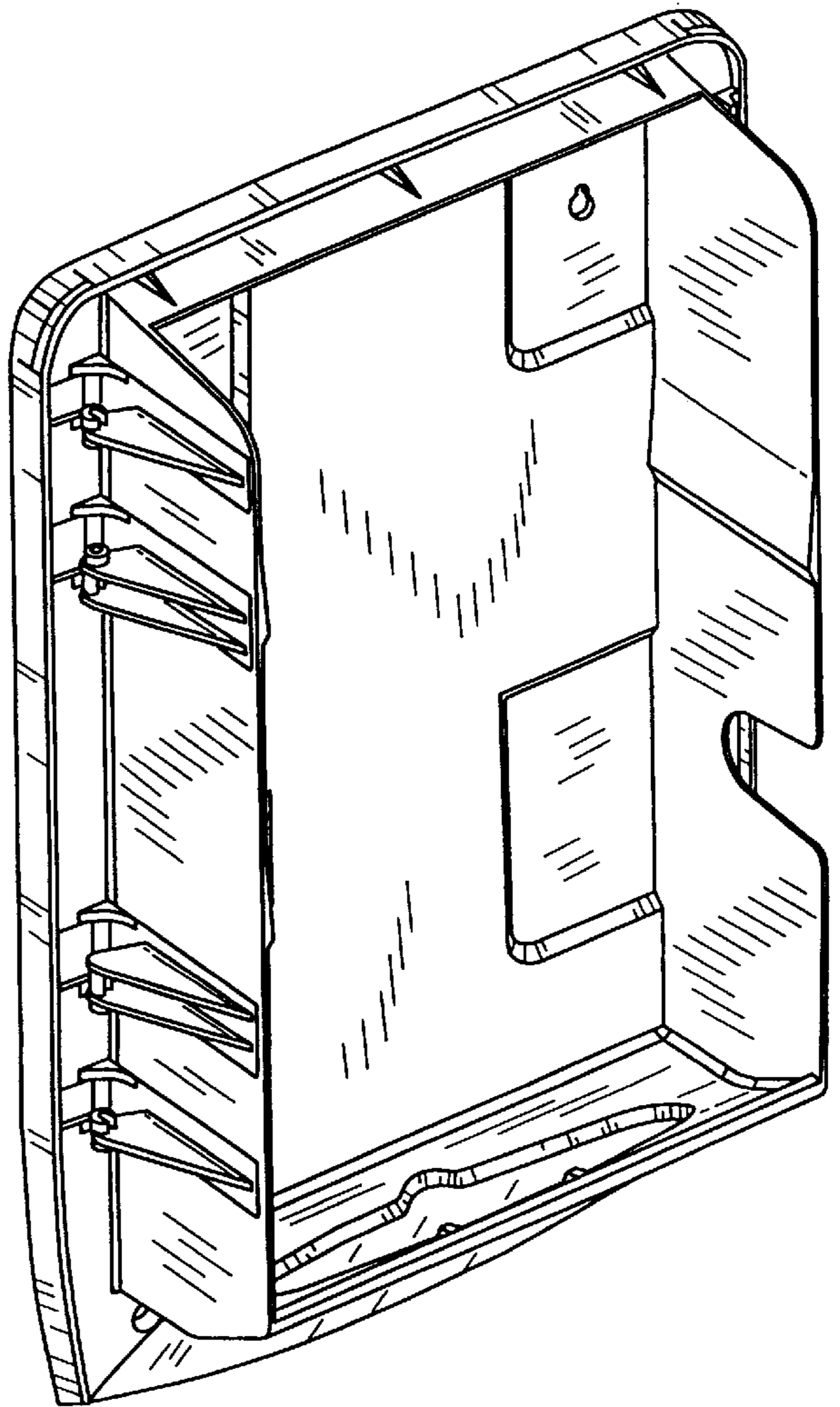

FIG. 4

FIG. 5

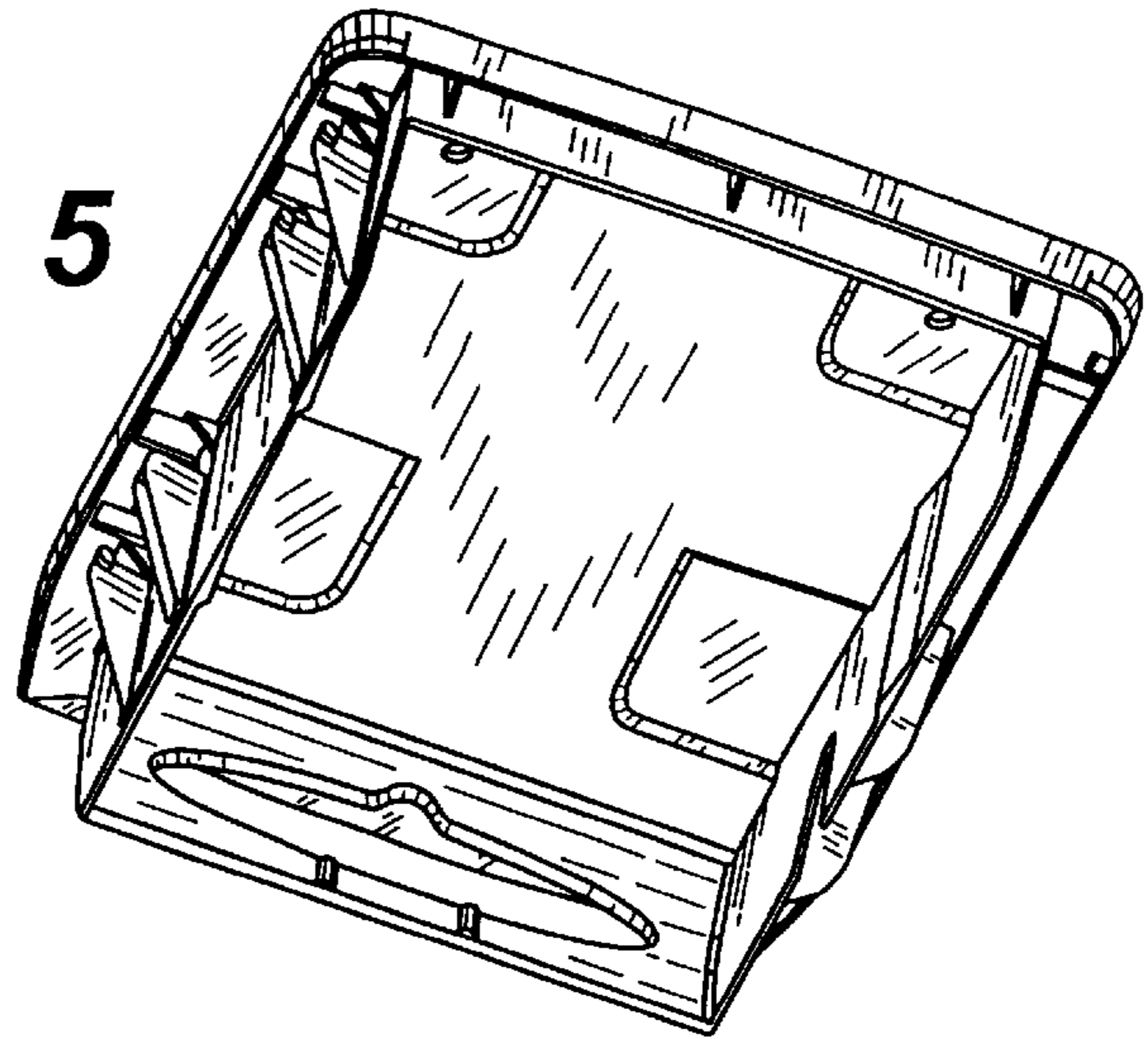

FIG. 6

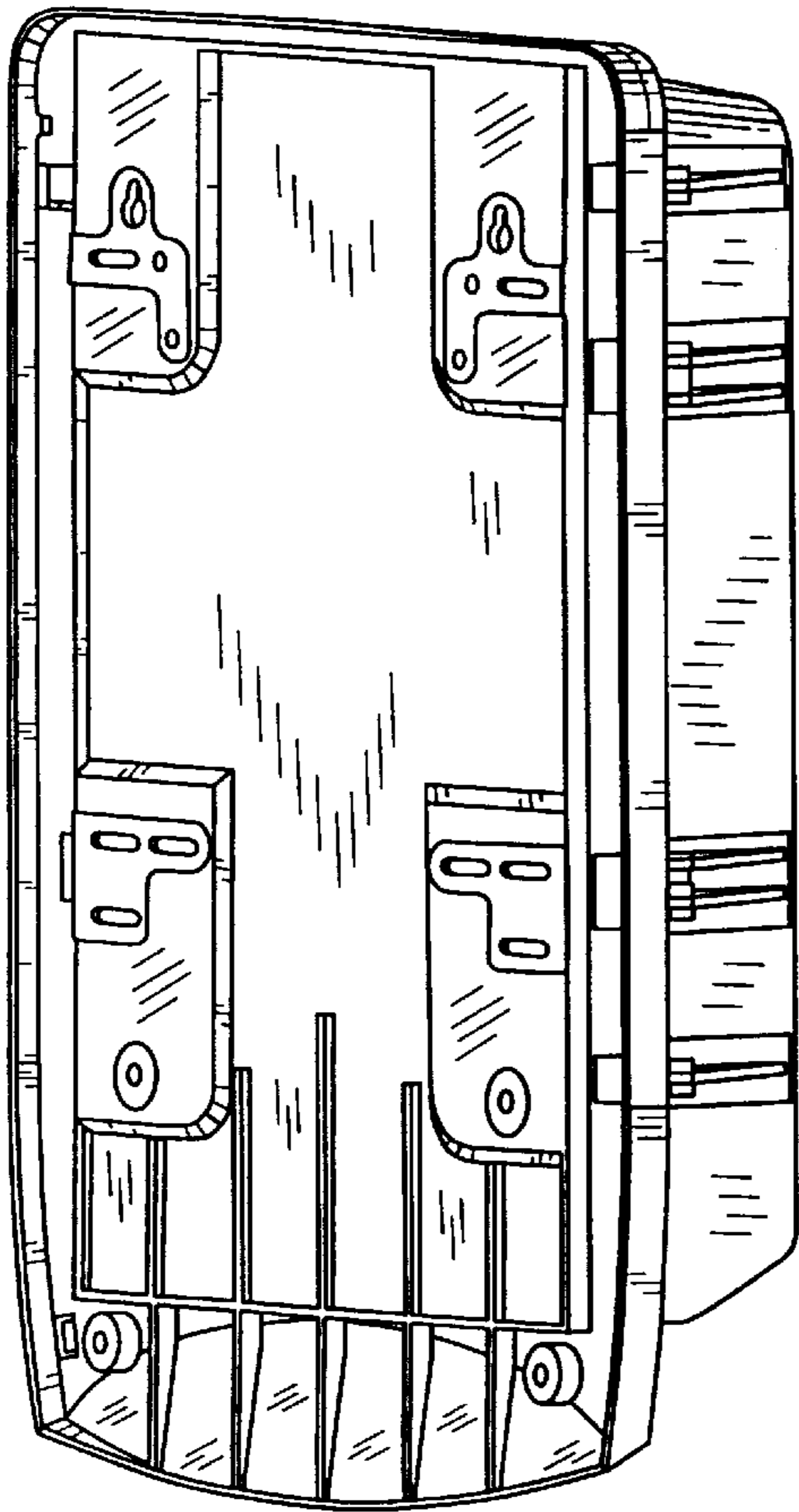

FIG. 7

