



US00D437417S

(12) **United States Design Patent**
Saad

(10) **Patent No.:** **US D437,417 S**

(45) **Date of Patent:** **** Feb. 6, 2001**

(54) **LIQUID CONTAINER FOR MEDICAL COLD THERAPY TREATMENT**

(75) **Inventor:** **Steve Edward Saad, Powell, TN (US)**

(73) **Assignee:** **DeRoyal Industries, Inc., Powell, TN (US)**

(**) **Term:** **14 Years**

(21) **Appl. No.:** **29/115,352**

(22) **Filed:** **Dec. 13, 1999**

(51) **LOC (7) Cl.** **24-04**

(52) **U.S. Cl.** **D24/200**

(58) **Field of Search** D24/200; 607/96,
607/104, 108-111; 388/811, 809, 812, 813,
814, 815

(56) **References Cited**

U.S. PATENT DOCUMENTS

4,112,943	9/1978	Adams .	
4,459,468	7/1984	Bailey .	
4,640,284	* 2/1987	Ruderian	607/96
5,174,285	12/1992	Fontenot .	
5,183,039	2/1993	Sarian et al. .	

5,241,958	*	9/1993	Noeldner	607/86
5,330,519	*	7/1994	Mason et al.	607/104
5,476,489	*	12/1995	Koewler	607/104
5,647,051		7/1997	Neer .	
5,895,418	*	4/1999	Saringer	607/104
6,023,932	*	2/2000	Johnston	62/3.5

* cited by examiner

Primary Examiner—Stella Reid

(74) *Attorney, Agent, or Firm*—Pitts & Brittan, P.C.

(57) **CLAIM**

The ornamental design of a liquid container for medical cold therapy treatment, as shown and described.

DESCRIPTION

FIG. 1 is a left perspective view thereof;
FIG. 2 is a left side view thereof;
FIG. 3 is a right side view thereof;
FIG. 4 is a top view thereof;
FIG. 5 is a bottom view thereof;
FIG. 6 is a back side view thereof
FIG. 7 is a front side view thereof; and,
FIG. 8 is a right perspective view thereof.

1 Claim, 7 Drawing Sheets

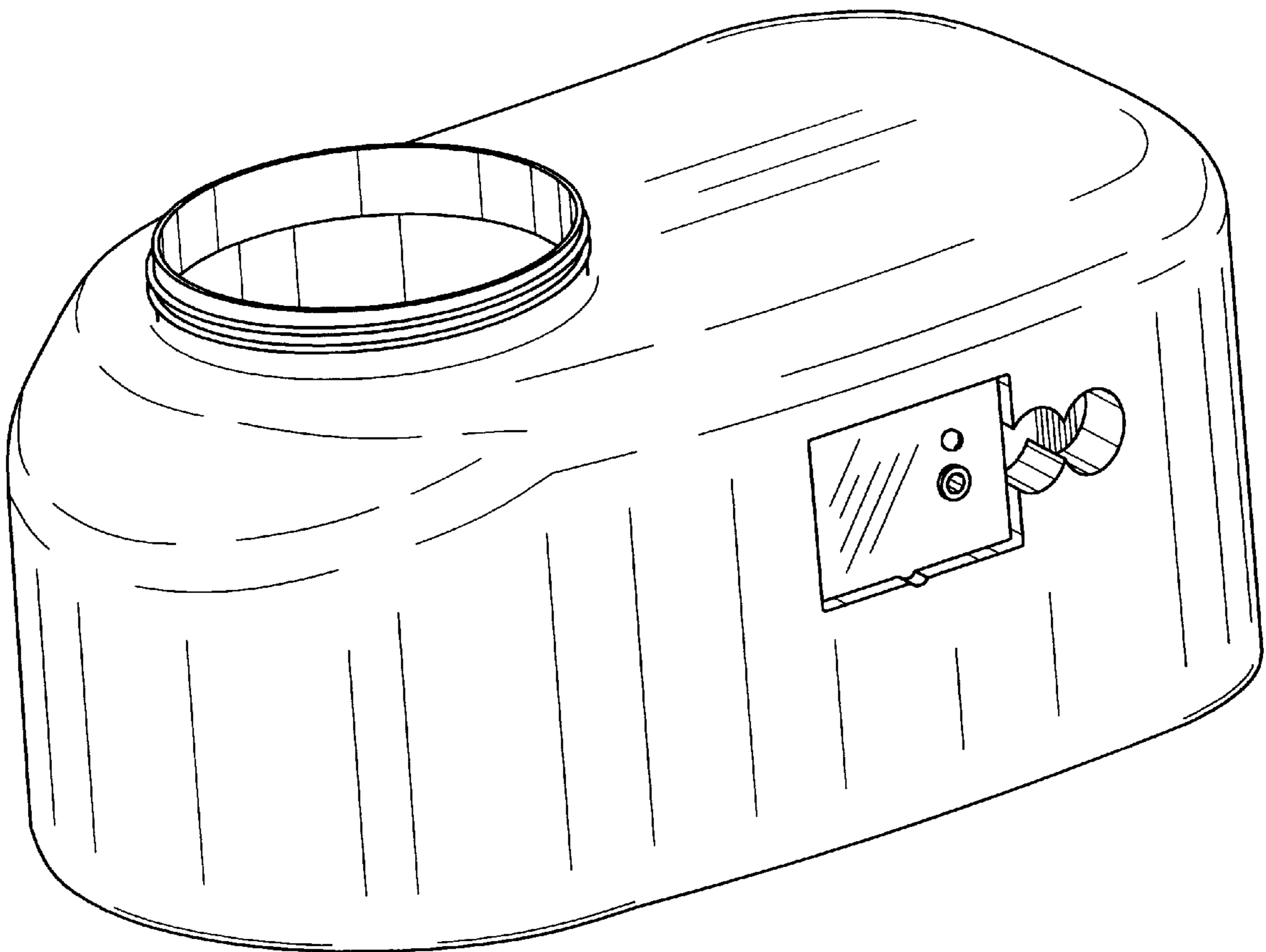

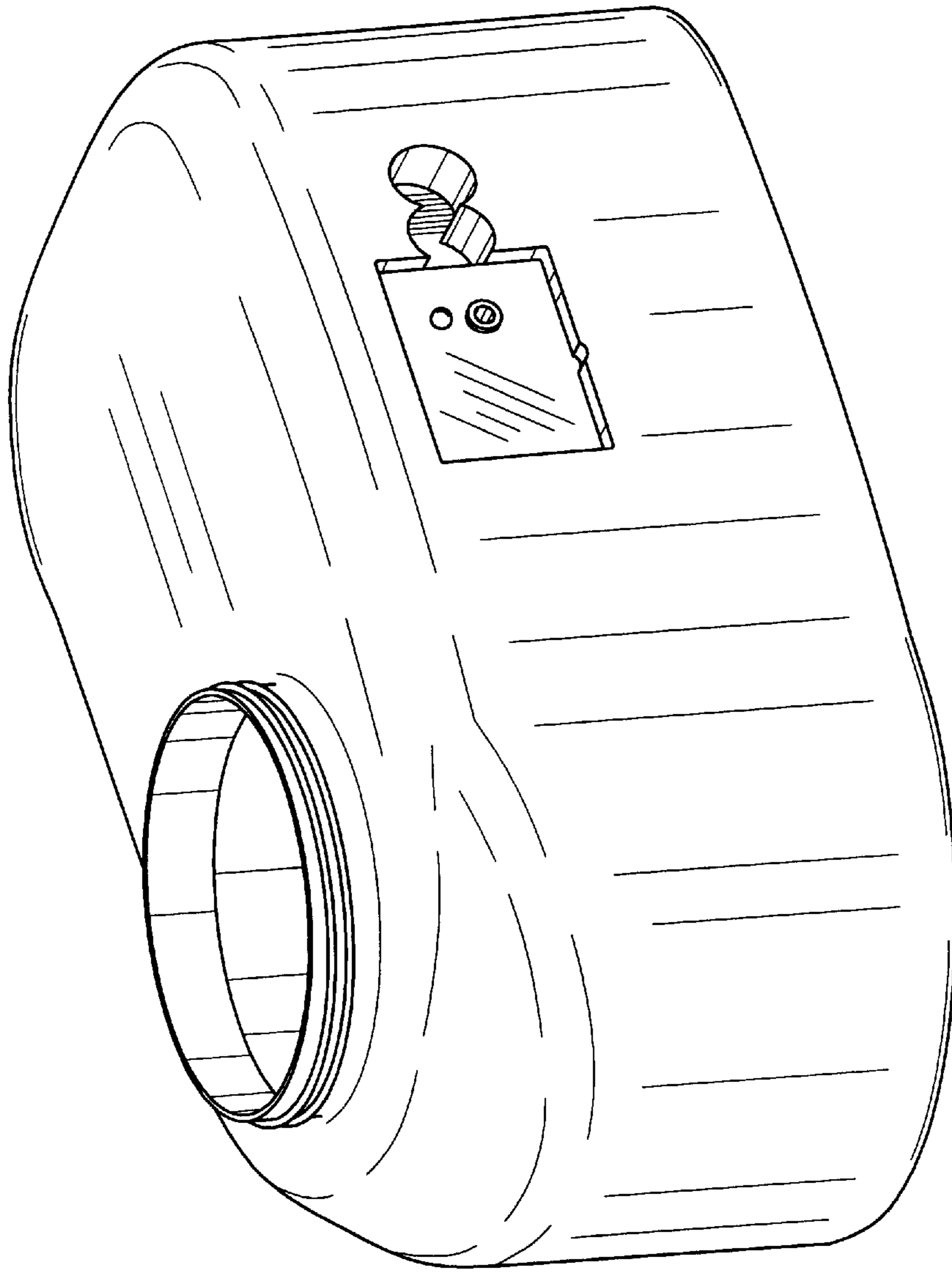

Fig. 1

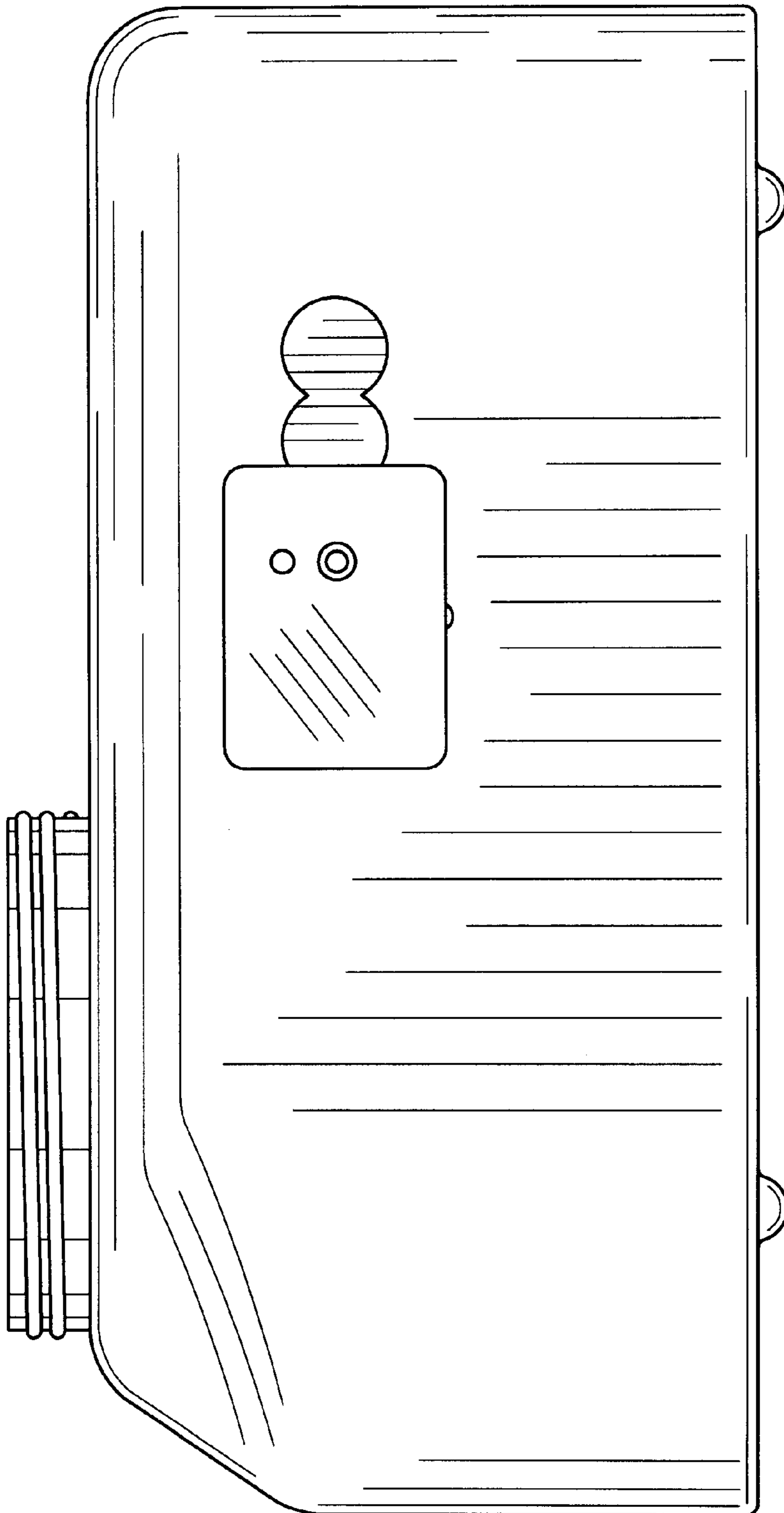

Fig. 2

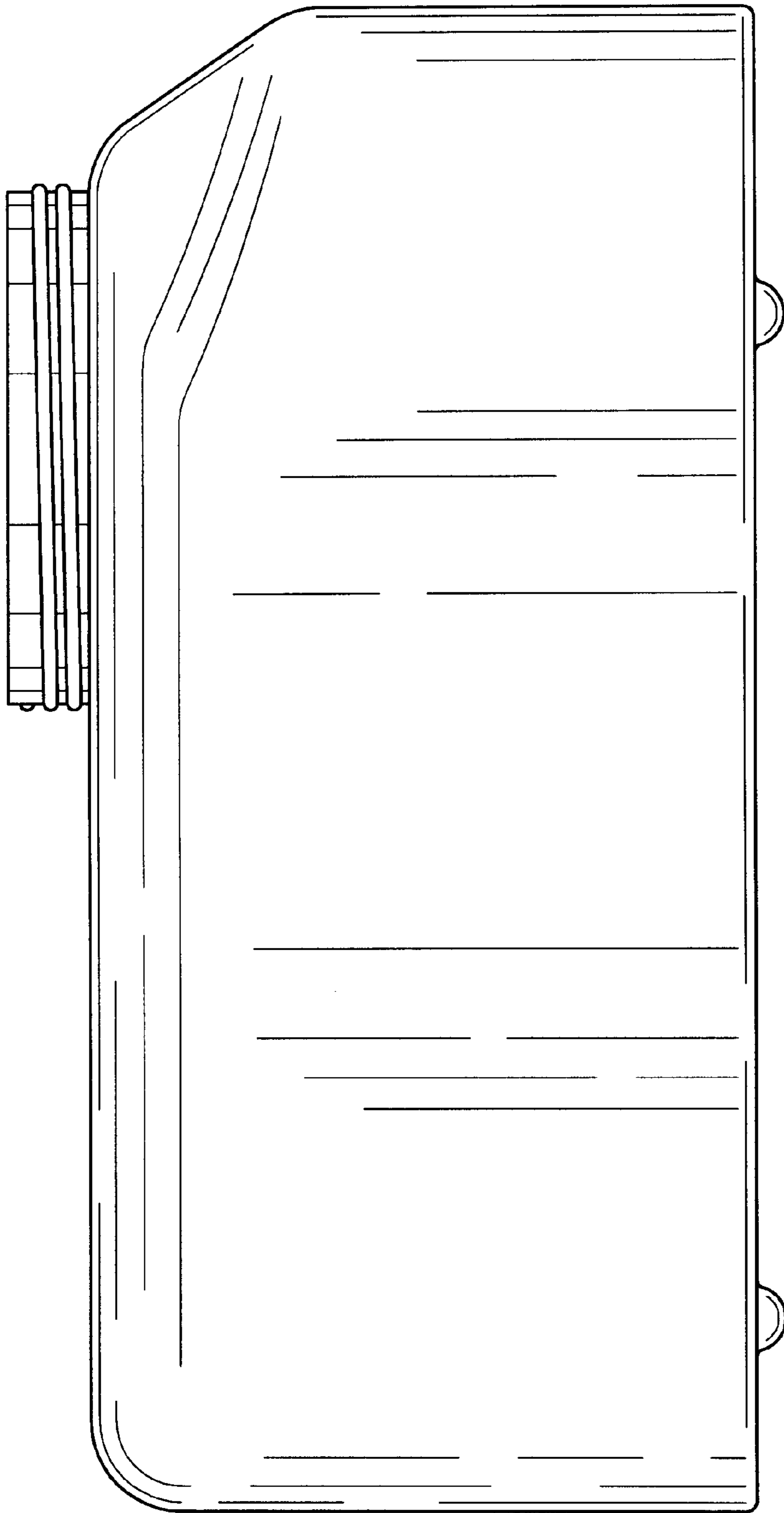

Fig. 3

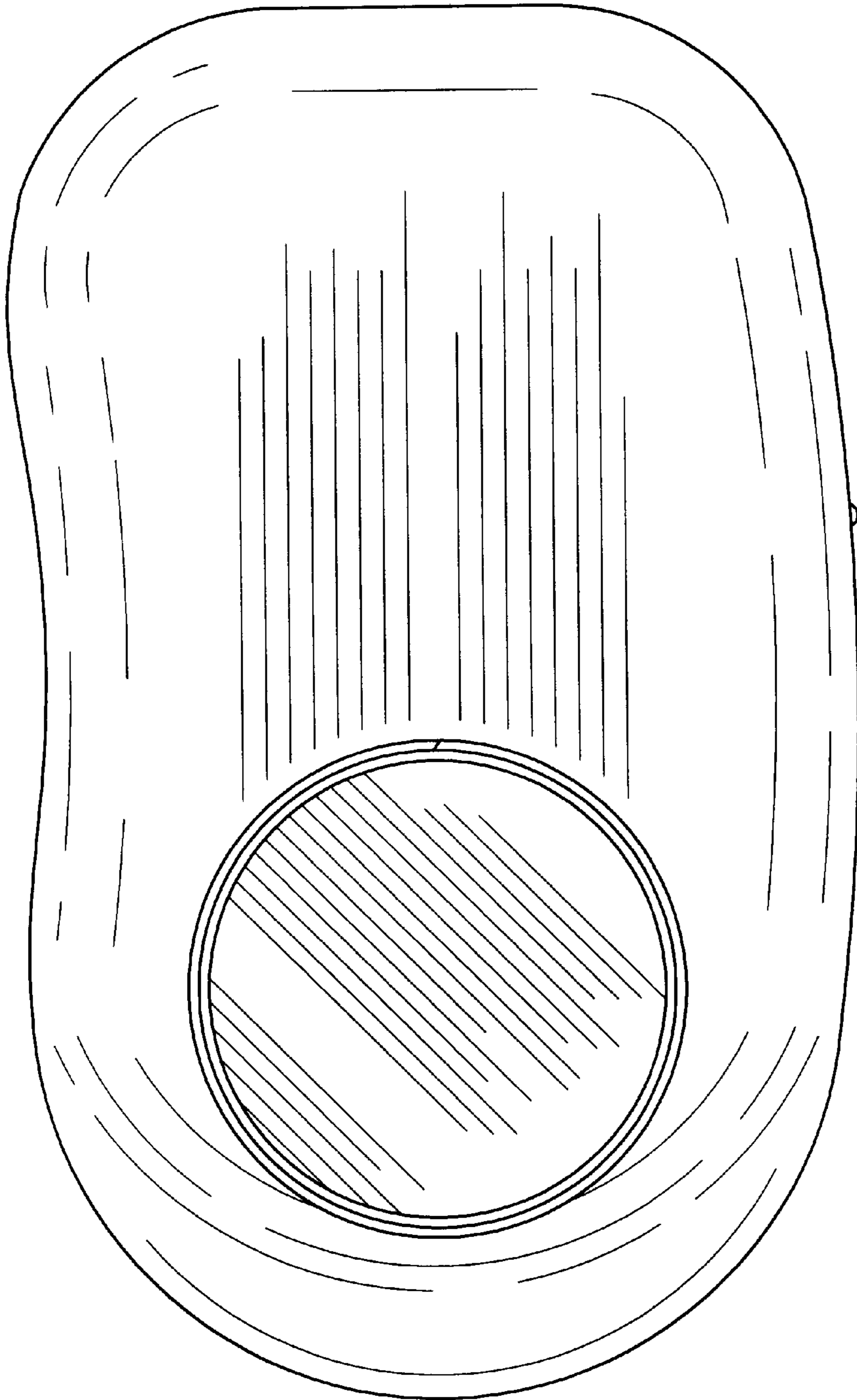

Fig. 4

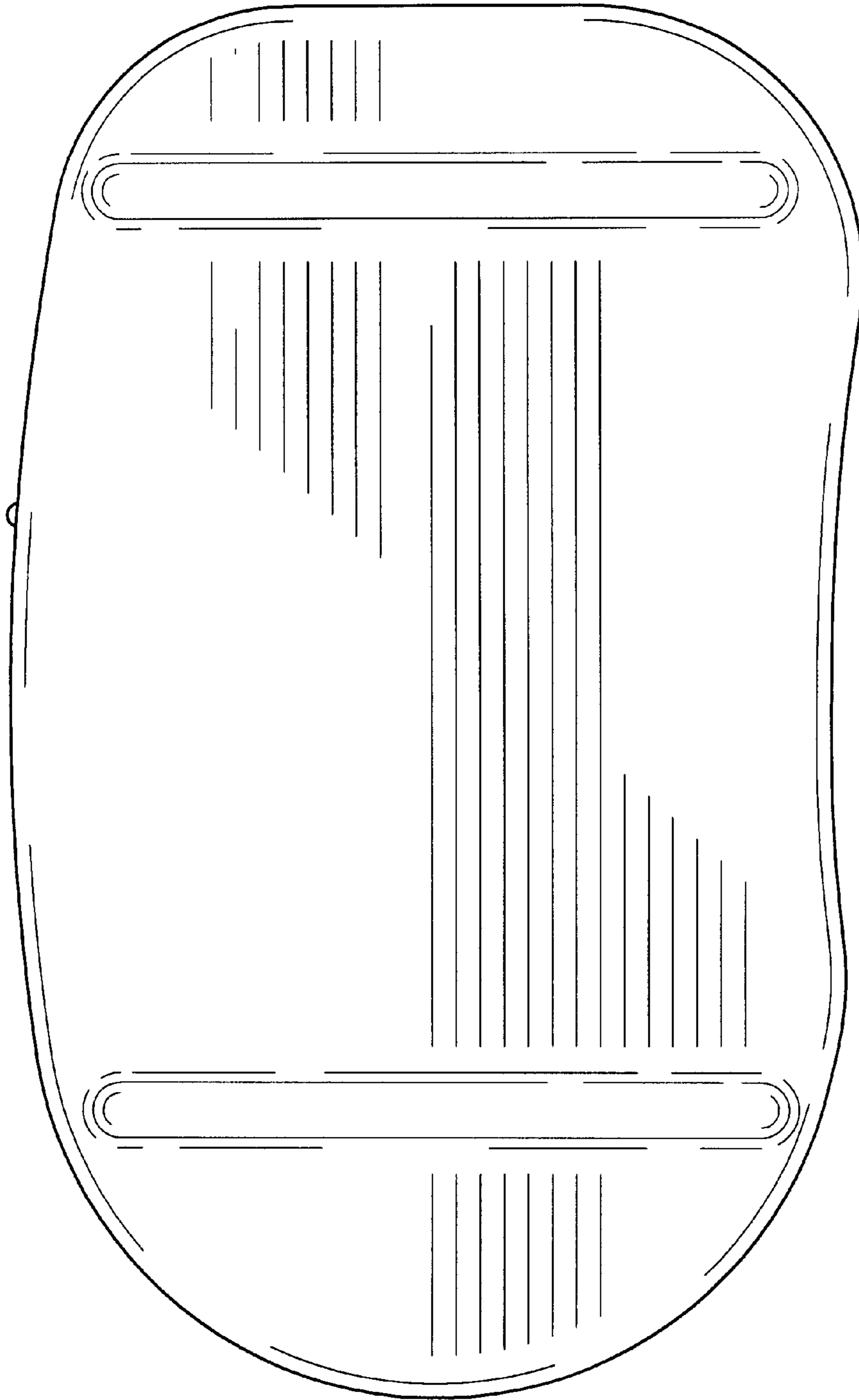

Fig. 5

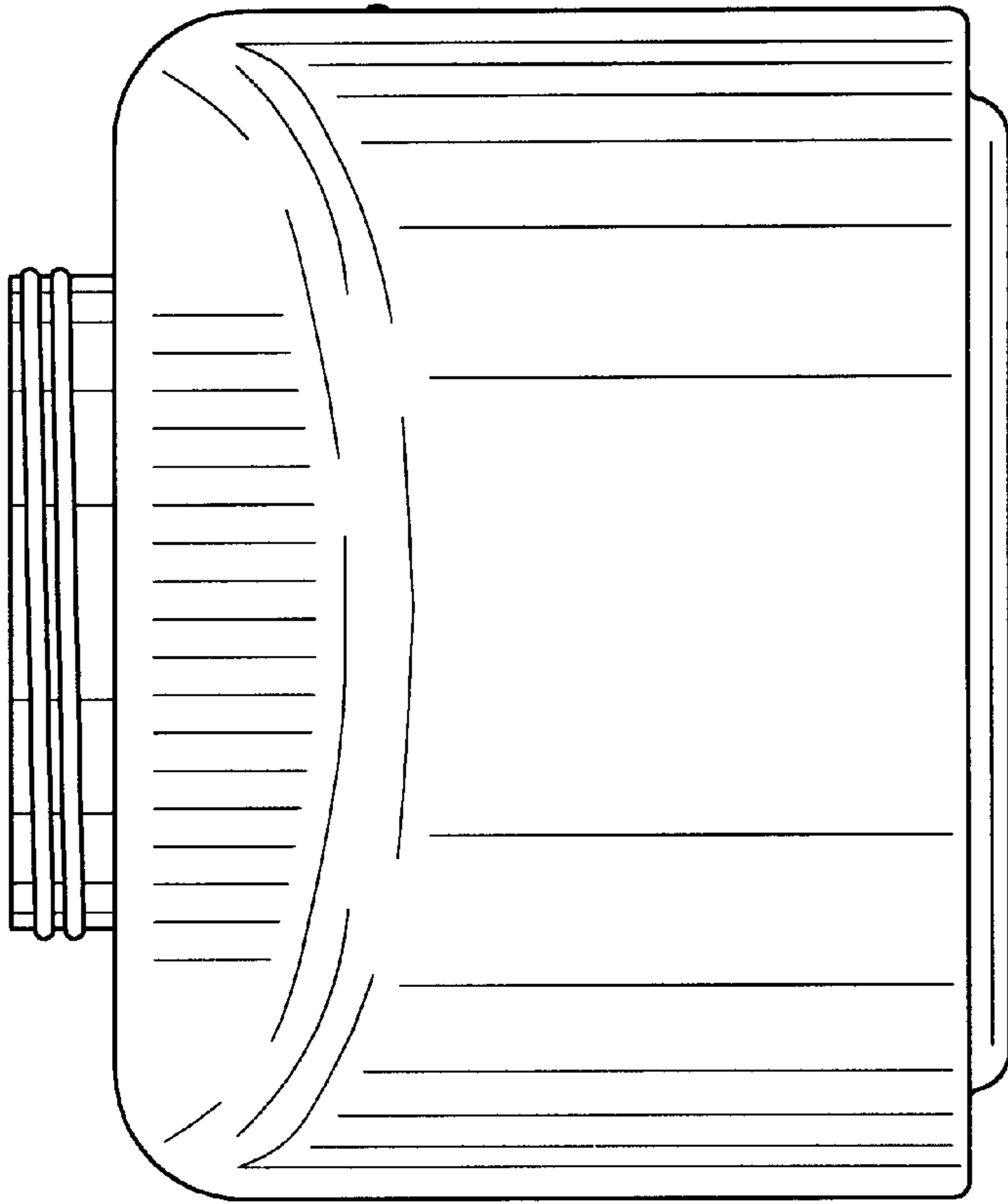

Fig. 7

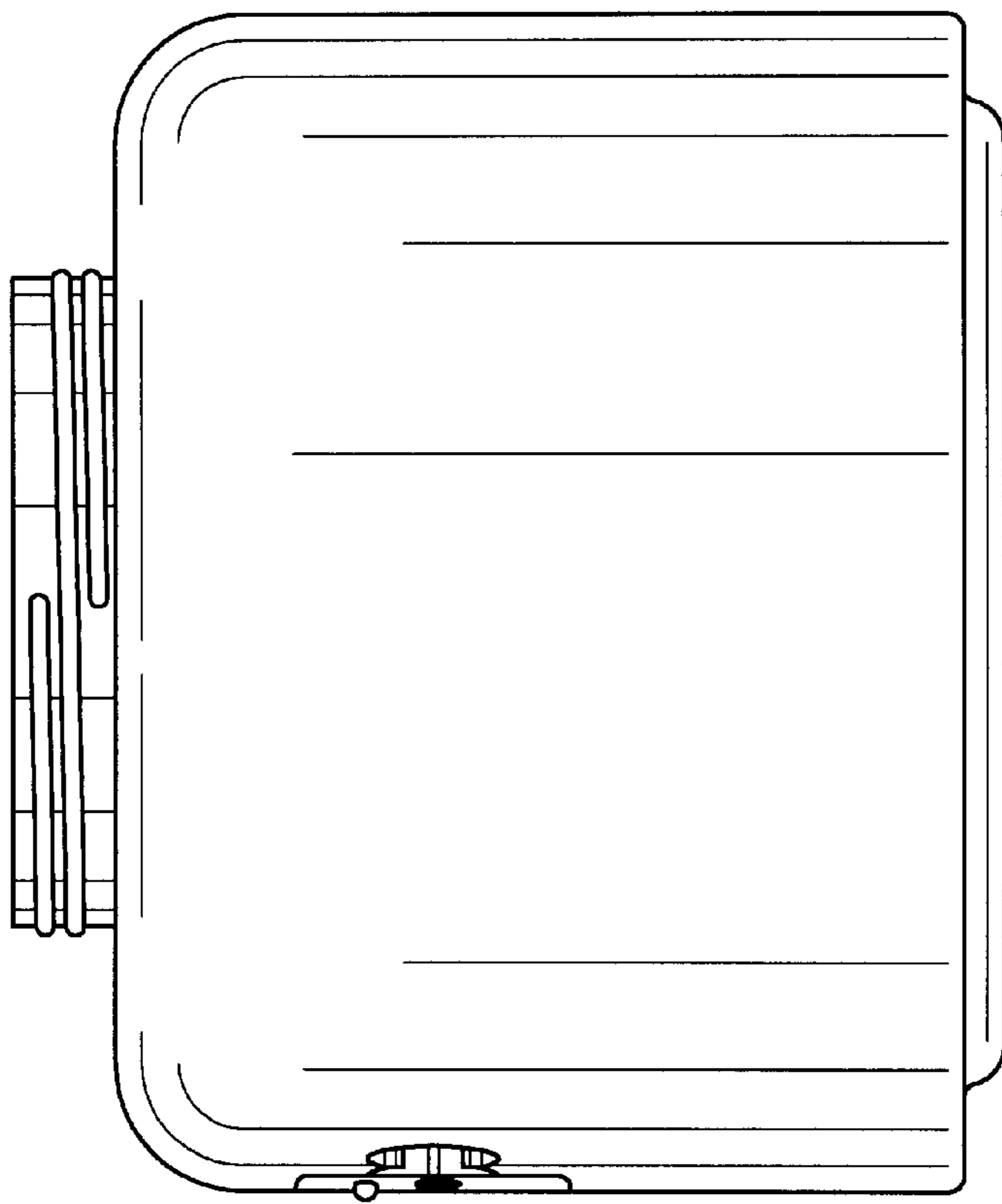

Fig. 6

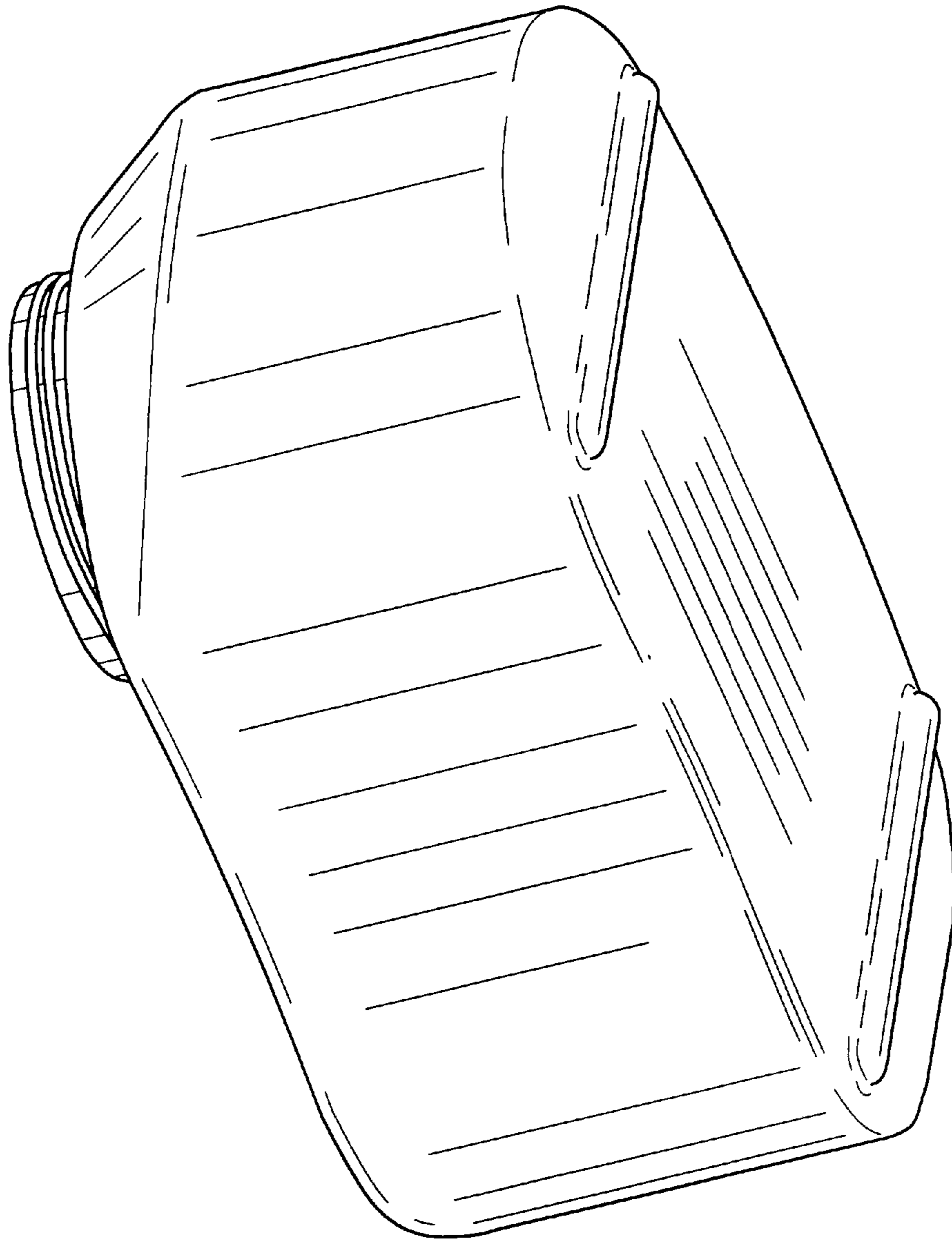

Fig. 8