



US00D437369S

(12) **United States Design Patent**
Tsushi

(10) **Patent No.:** **US D437,369 S**

(45) **Date of Patent:** **** Feb. 6, 2001**

(54) **BICYCLE EXERCISING MACHINE**

(75) Inventor: **Masao Tsushi, Osaka (JP)**

(73) Assignee: **Cateye Co., Ltd., Osaka (JP)**

(**) Term: **14 Years**

(21) Appl. No.: **29/118,296**

(22) Filed: **Feb. 7, 2000**

(30) **Foreign Application Priority Data**

Aug. 10, 1999 (JP) 11-21624

(51) **LOC (7) Cl.** **21-02**

(52) **U.S. Cl.** **D21/666; D21/663**

(58) **Field of Search** D21/662, 663,
D21/664, 665, 666, 667, 670; 482/51, 57,
58

(56) **References Cited**

U.S. PATENT DOCUMENTS

- D. 307,928 * 5/1990 Meisner D21/663
- D. 318,086 * 7/1991 Bingham et al. D21/666
- D. 342,299 * 12/1993 Birrell et al. D21/666

- D. 355,942 * 2/1995 Wu D21/666
- D. 372,060 * 7/1996 Wang et al. D21/666
- D. 398,673 * 9/1998 Huang D21/663
- D. 399,894 * 10/1998 Chiu D21/663
- 6,001,046 * 12/1999 Chang 482/57

* cited by examiner

Primary Examiner—Philip S. Hyder

(74) *Attorney, Agent, or Firm*—Olson & Hierl, Ltd.

(57) **CLAIM**

The ornamental design for a bicycle exercising machine, as shown and described.

DESCRIPTION

FIG. 1 is a front view of a bicycle exercising machine showing my new design;
 FIG. 2 is a rear view thereof;
 FIG. 3 is a top view thereof;
 FIG. 4 is a bottom view thereof;
 FIG. 5 is a left side view thereof;
 FIG. 6 is a right side view thereof; and,
 FIG. 7 is a rear perspective view thereof.

1 Claim, 3 Drawing Sheets

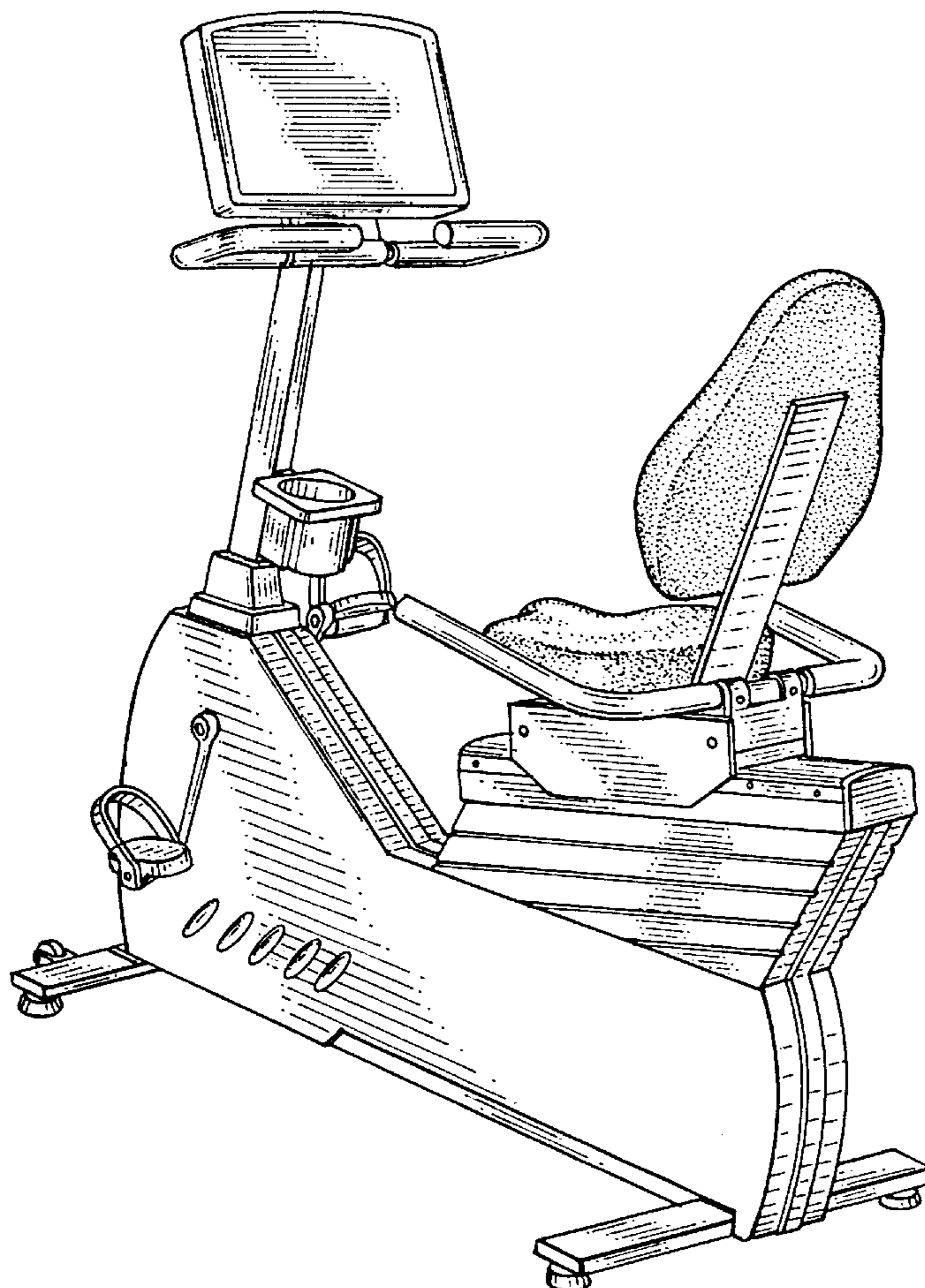

FIG. 1

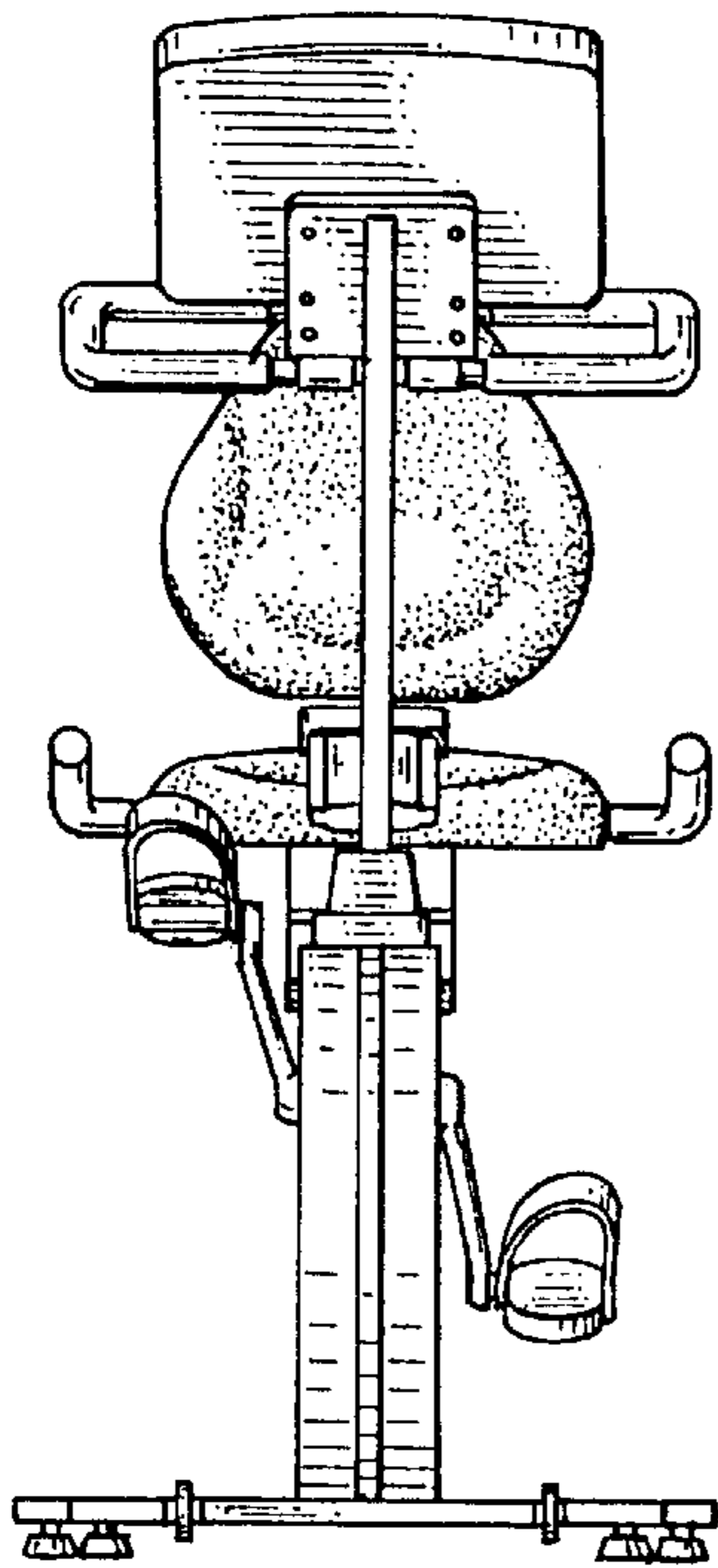

FIG. 2

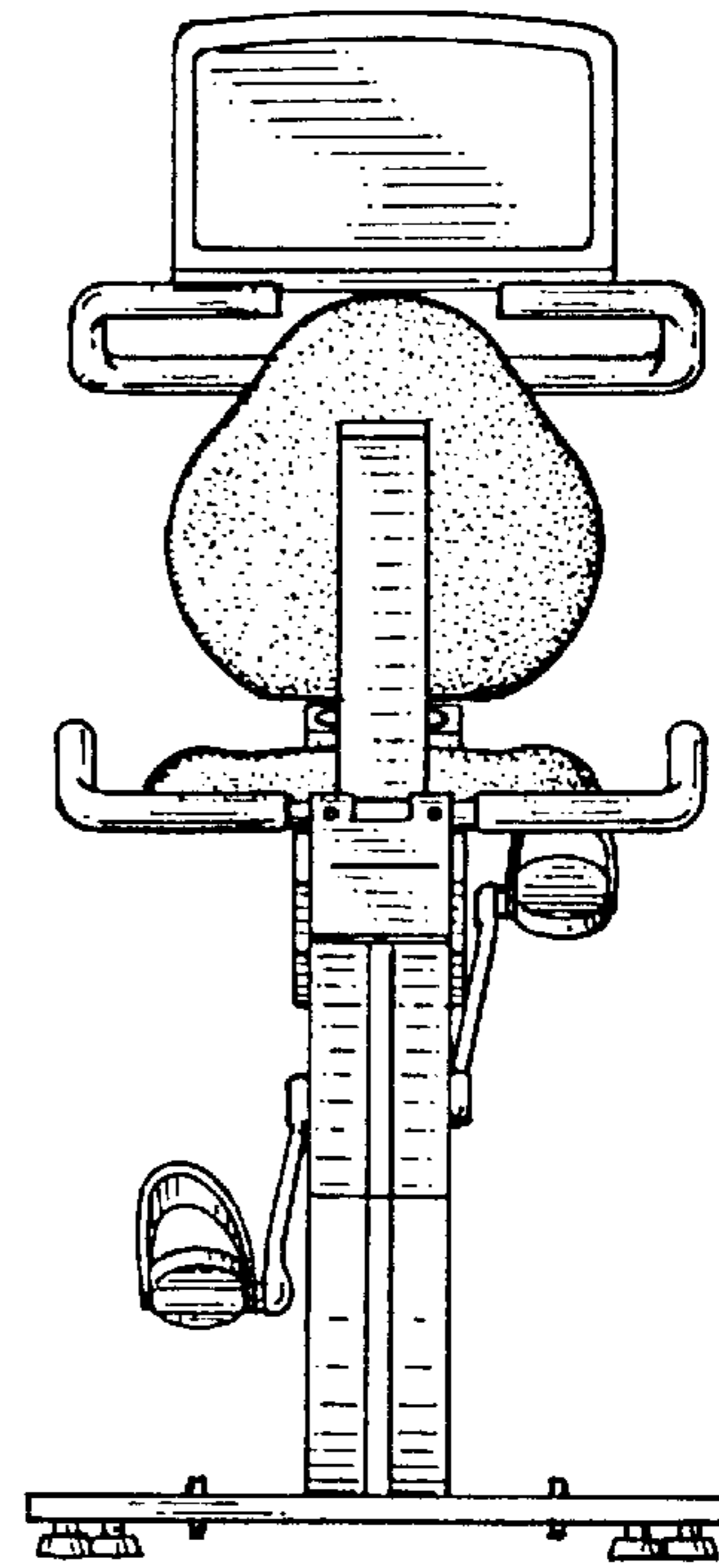

FIG. 3

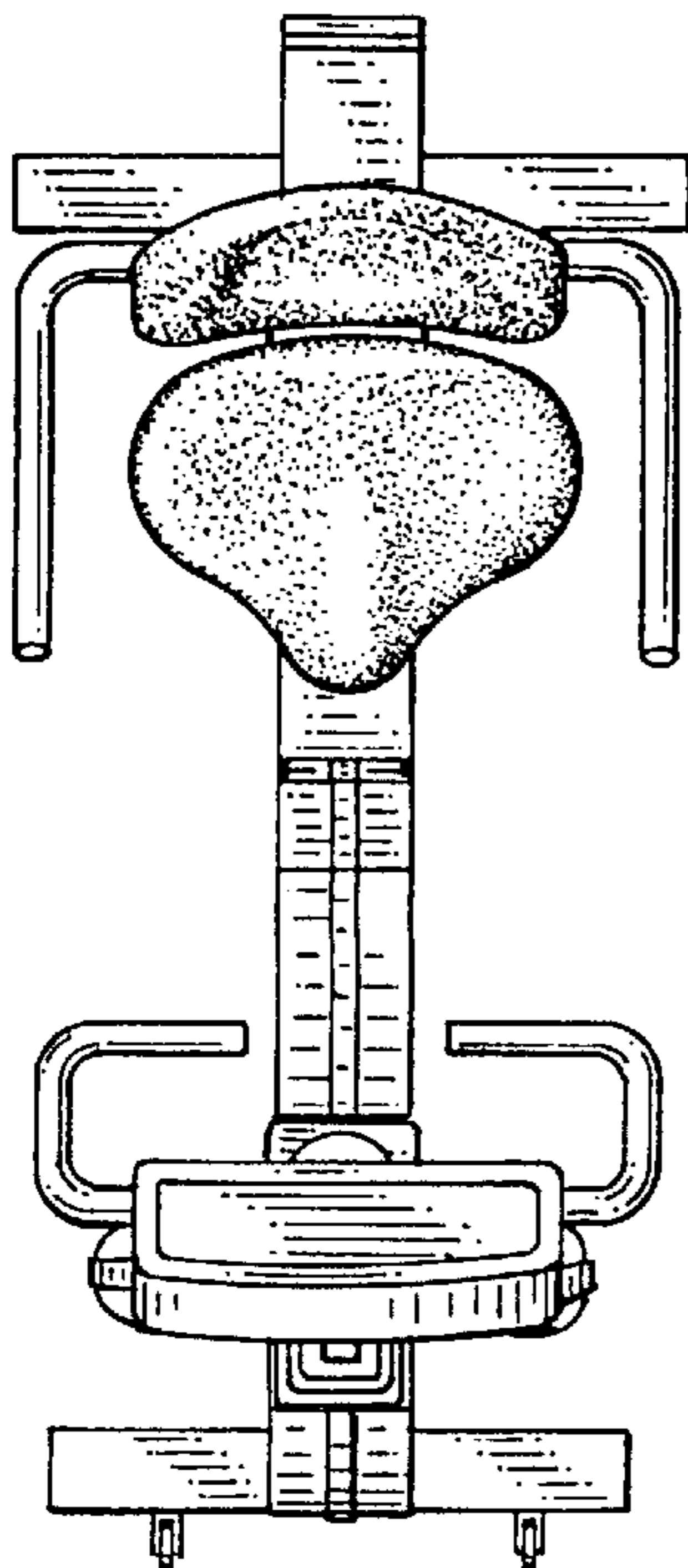

FIG. 4

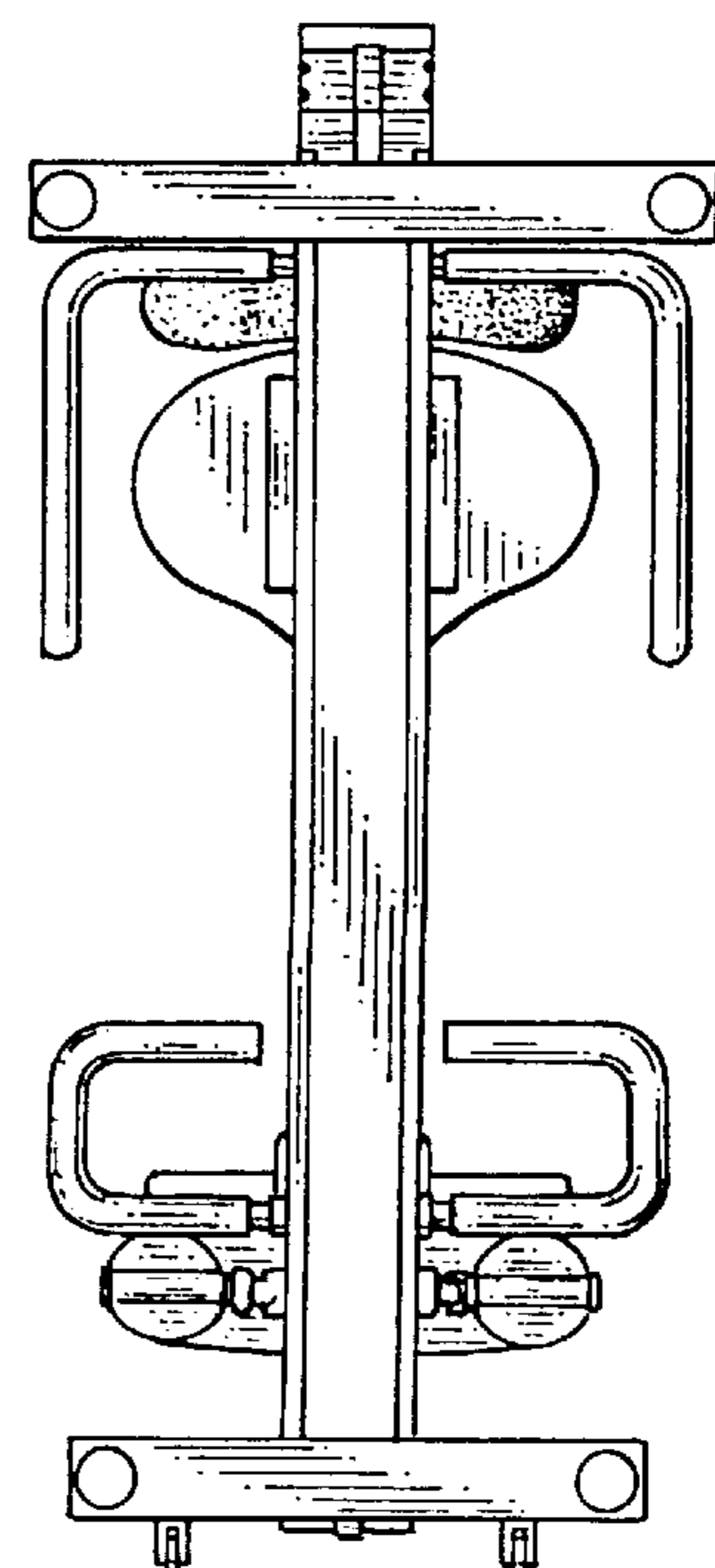

FIG. 6

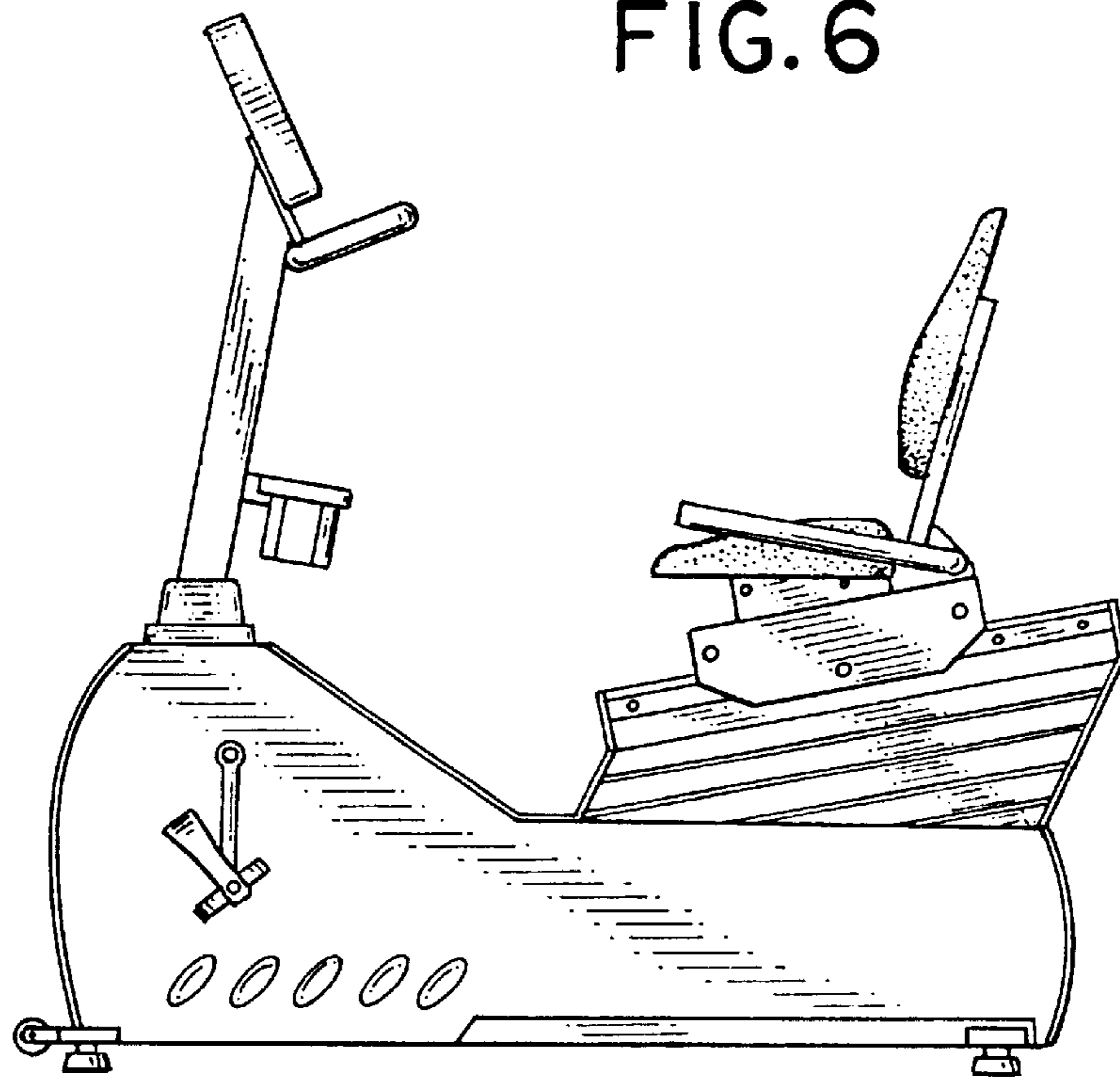

FIG. 5

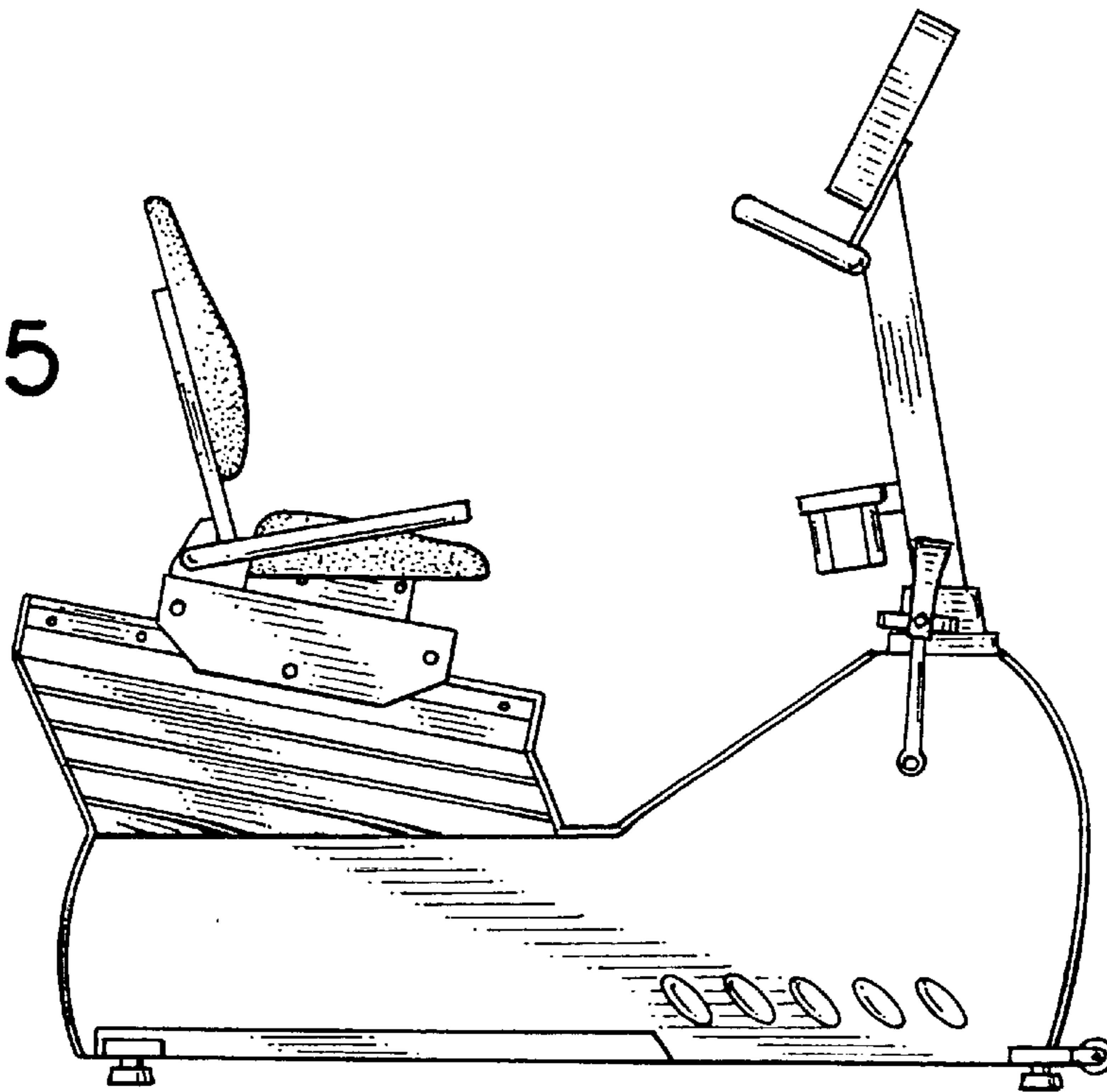

FIG. 7

