



US00D437160S

(12) **United States Design Patent**
Broussard

(10) **Patent No.:** **US D437,160 S**

(45) **Date of Patent:** **** Feb. 6, 2001**

(54) **TUBE SQUEEZER**

5,511,696 * 4/1996 Gustafson 222/102
5,920,967 * 7/1999 Souza 222/103

(76) Inventor: **Philip J. Broussard**, P.O. Box 5, Lydia,
LA (US) 70569

* cited by examiner

(**) Term: **14 Years**

Primary Examiner—Philip S. Hyder

(74) *Attorney, Agent, or Firm*—Robert N. Montgomery

(21) Appl. No.: **29/119,134**

(57) **CLAIM**

(22) Filed: **Feb. 24, 2000**

The ornamental design for a tube squeezer, as shown and described.

(51) **LOC (7) Cl.** **06-02**

(52) **U.S. Cl.** **D6/541**

(58) **Field of Search** D8/14, 51; D6/541;
222/100, 101, 102, 103

DESCRIPTION

(56) **References Cited**

U.S. PATENT DOCUMENTS

D. 317,689	*	6/1991	Curtis	D6/541
D. 351,521	*	10/1994	Knight, III	D6/541
3,586,213	*	6/1971	Gill	222/102
3,885,708	*	5/1975	Parry	222/100
3,970,220	*	7/1976	Spears	222/102
4,030,636	*	6/1977	Drancourt	222/102
5,178,302	*	1/1993	Cheng	222/102

FIG. 1 is a left side isometric view of the tube squeezer;
FIG. 2 is a right side isometric view of the tube squeezer;
FIG. 3 is a top view of the tube squeezer;
FIG. 4 is a bottom view of the tube squeezer illustrating a rough textured roller surface;
FIG. 5 is a front view of the tube squeezer;
FIG. 6 is a rear view of the tube squeezer;
FIG. 7 is a right side view of the tube squeezer; and,
FIG. 8 is a left side view of the tube squeezer.

1 Claim, 2 Drawing Sheets

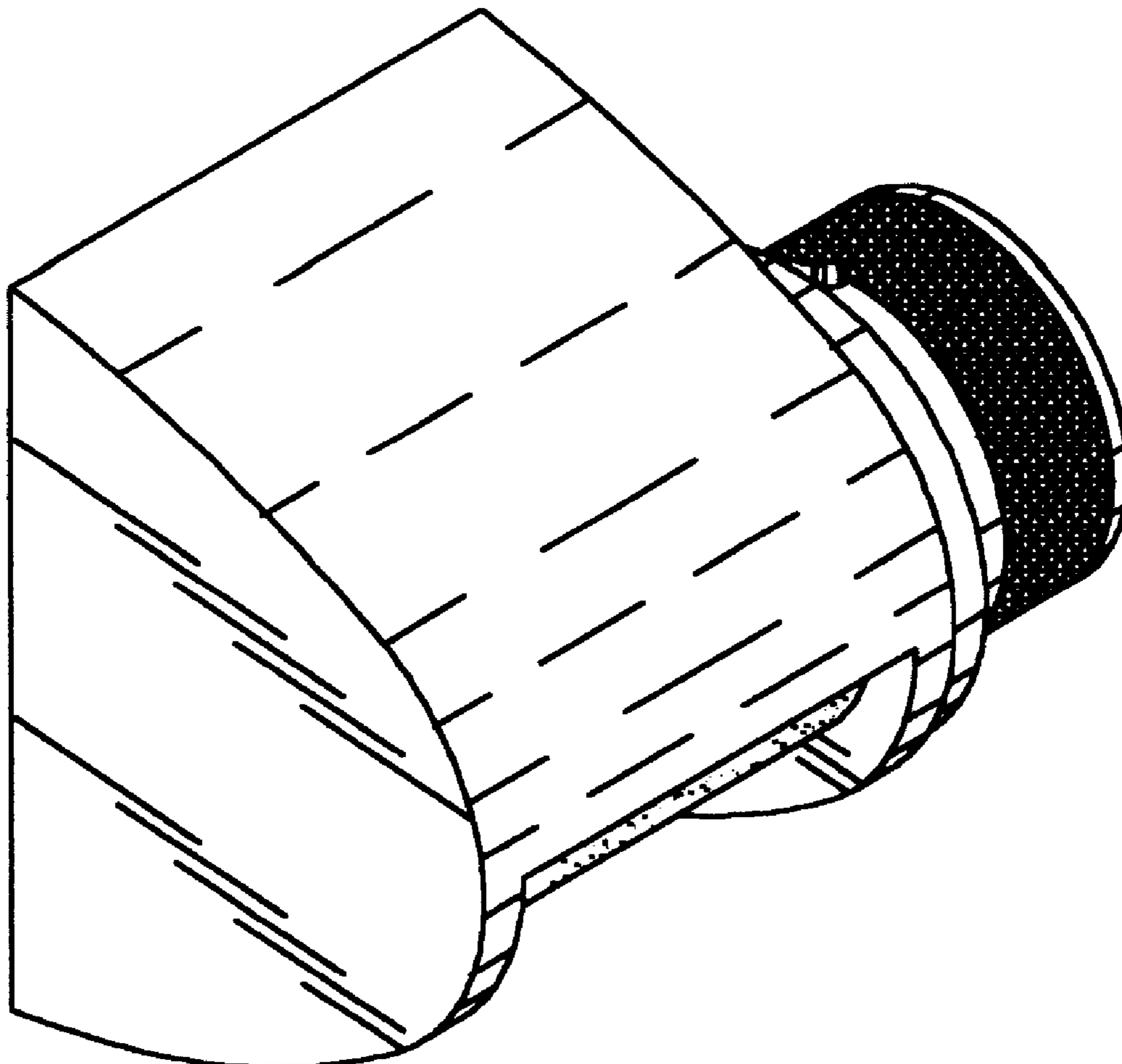

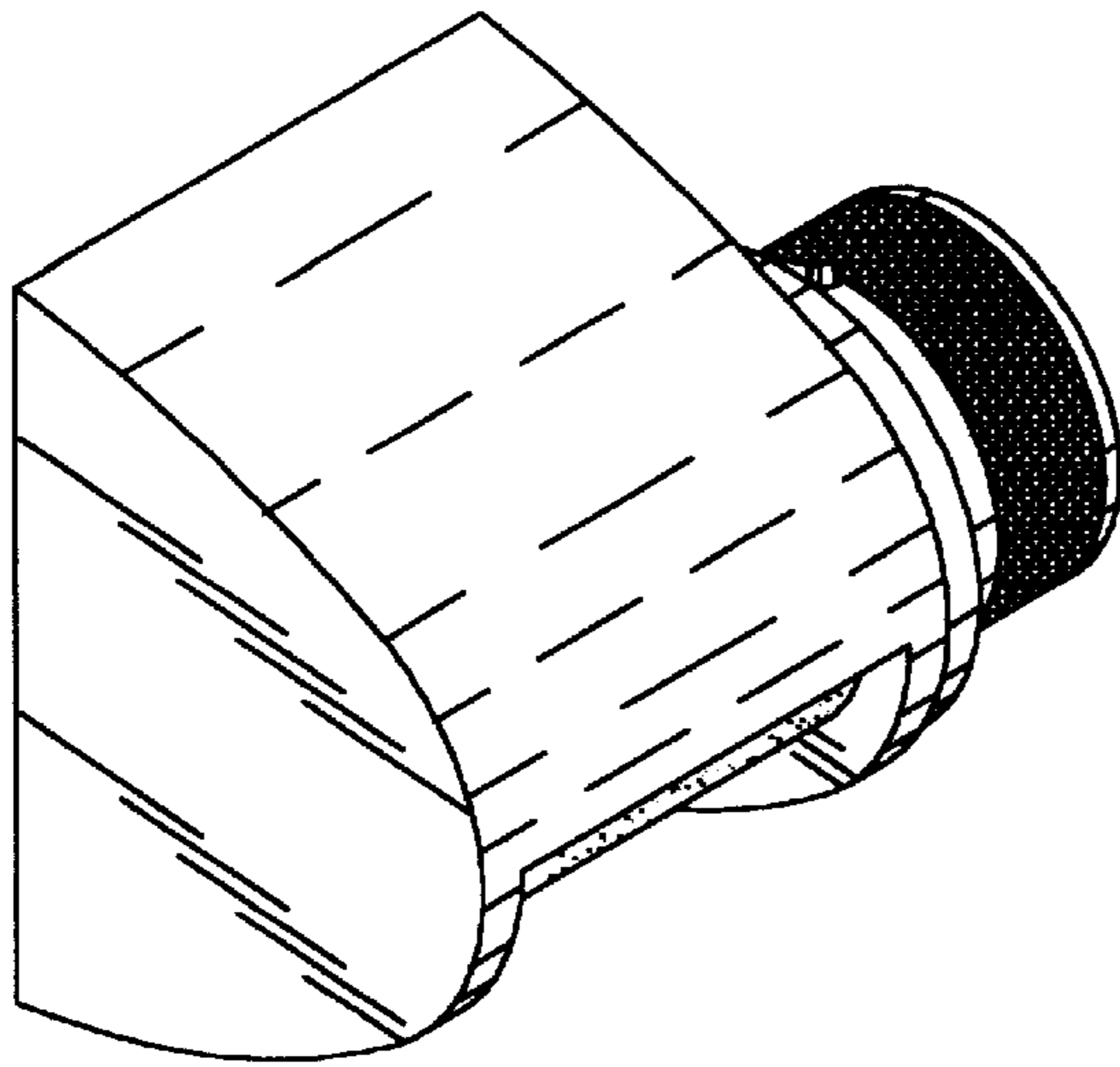

FIG. 1

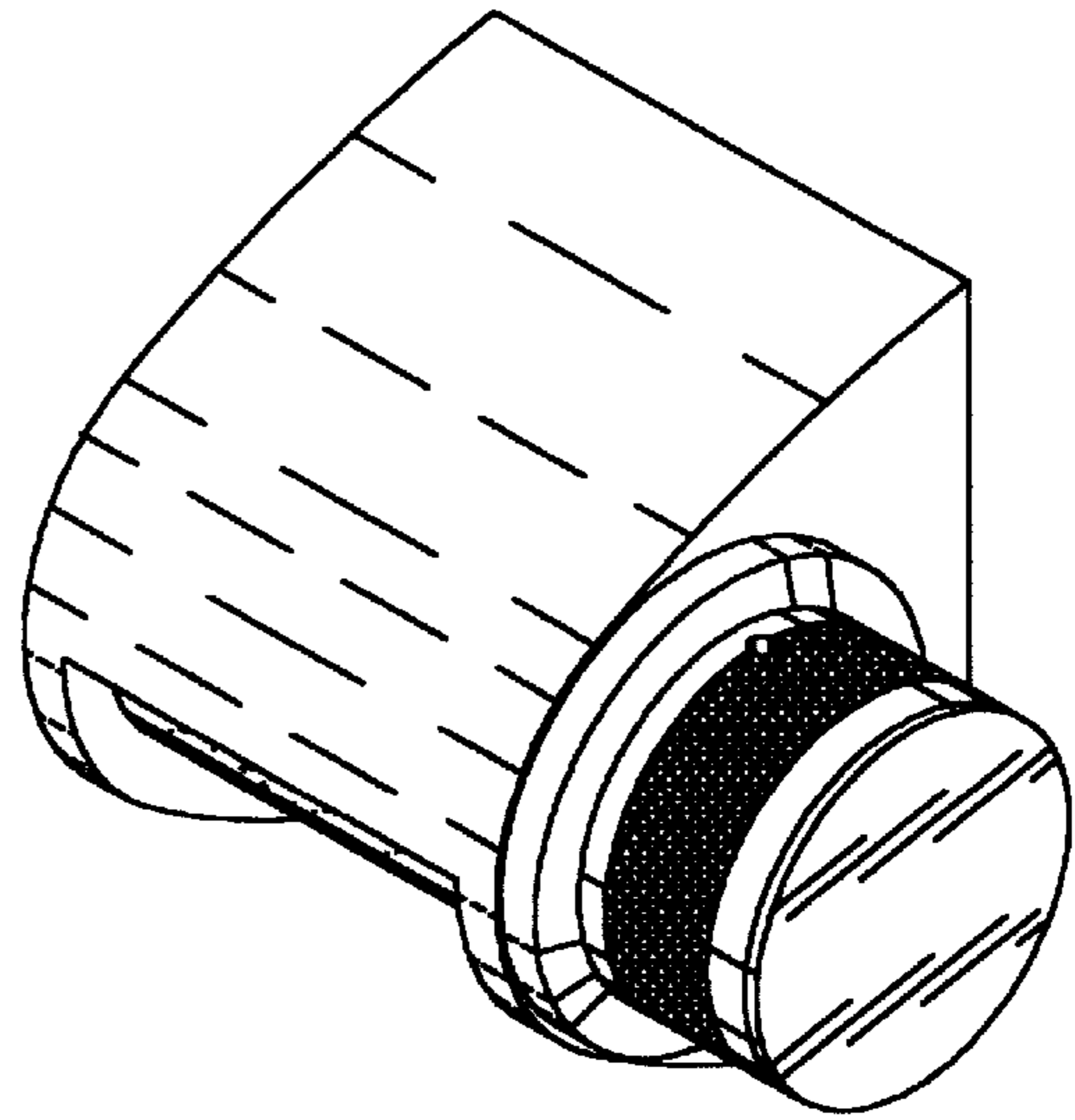

FIG. 2

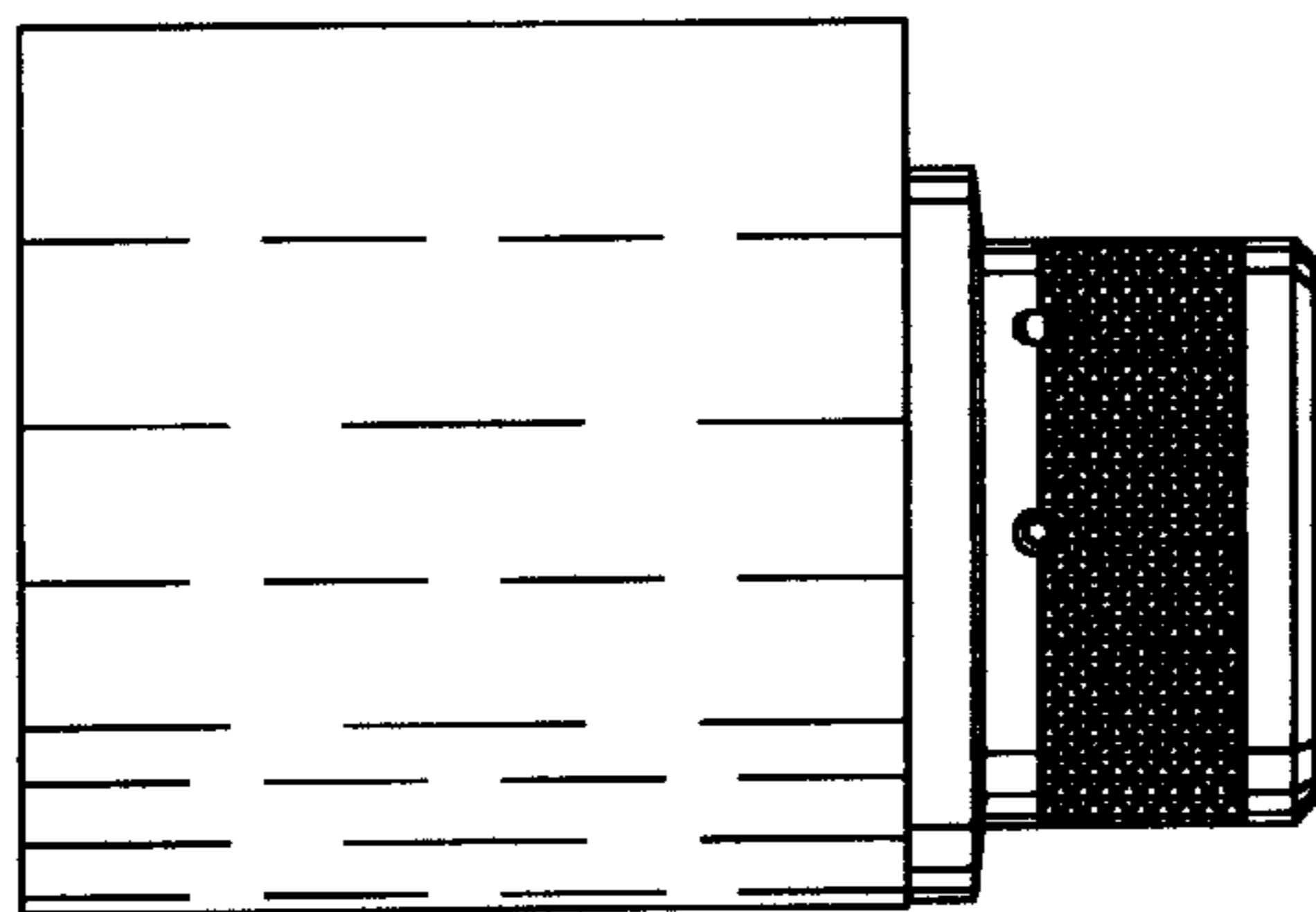

FIG. 3

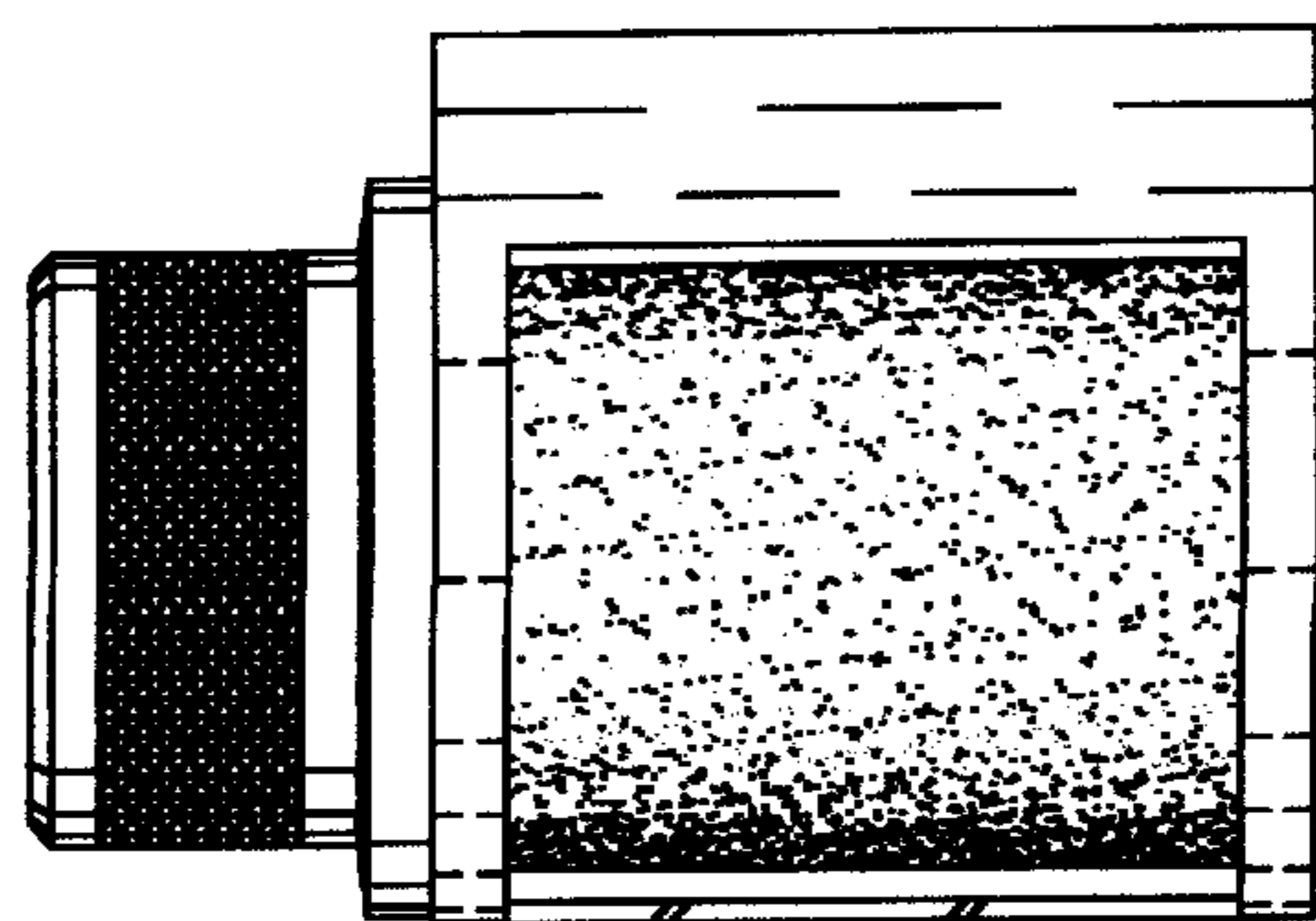

FIG. 4

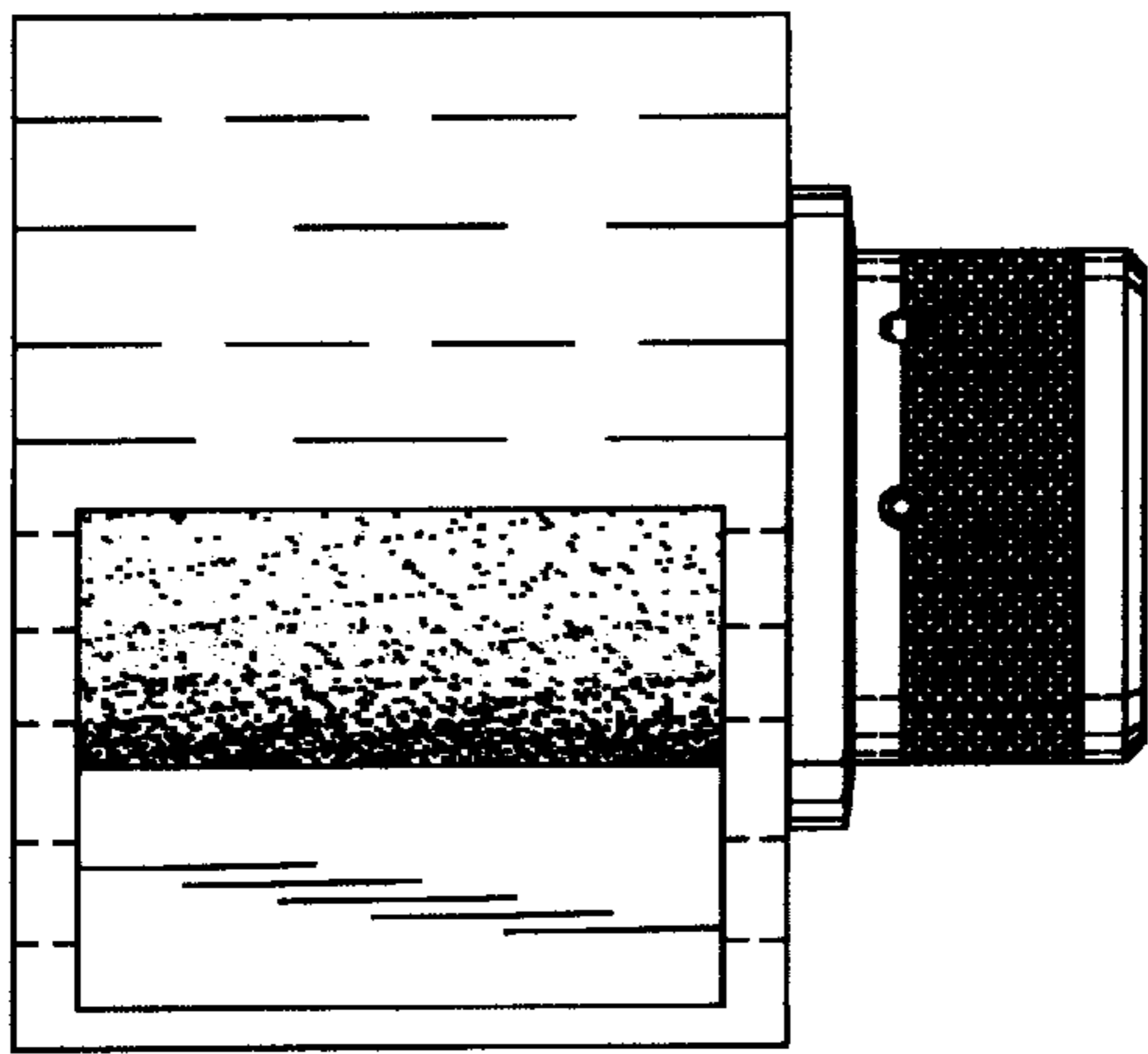

FIG. 5

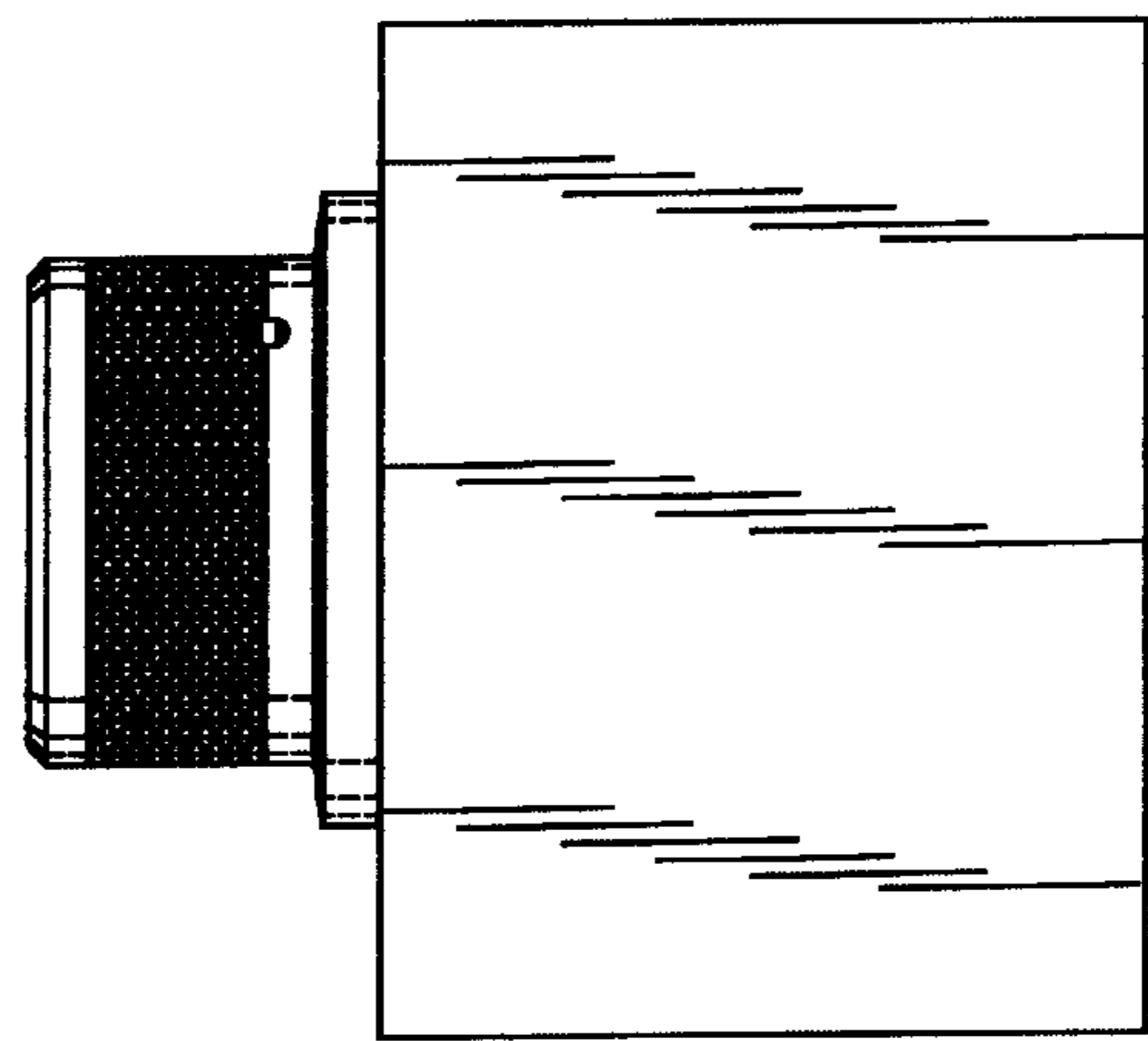

FIG. 6

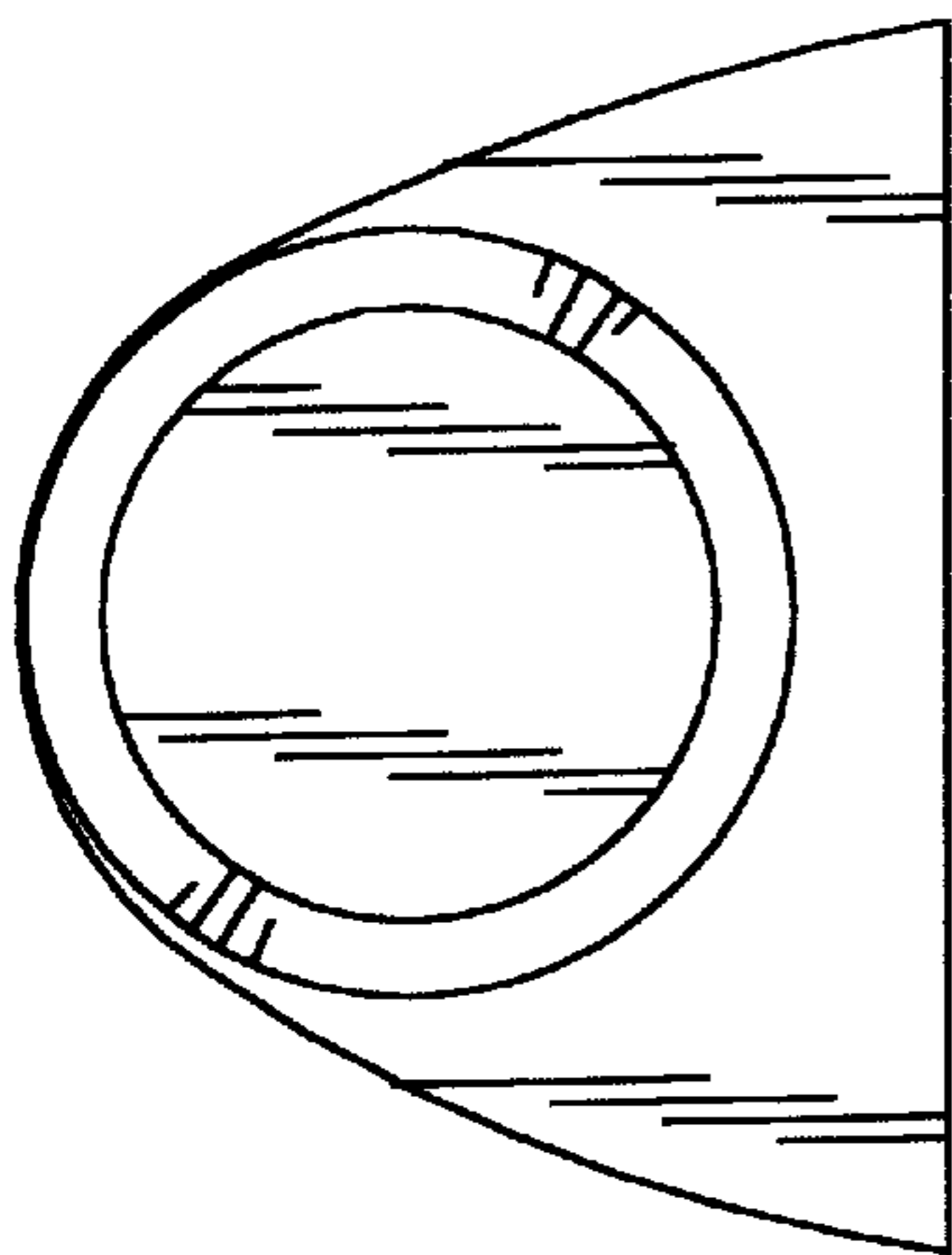

FIG. 7

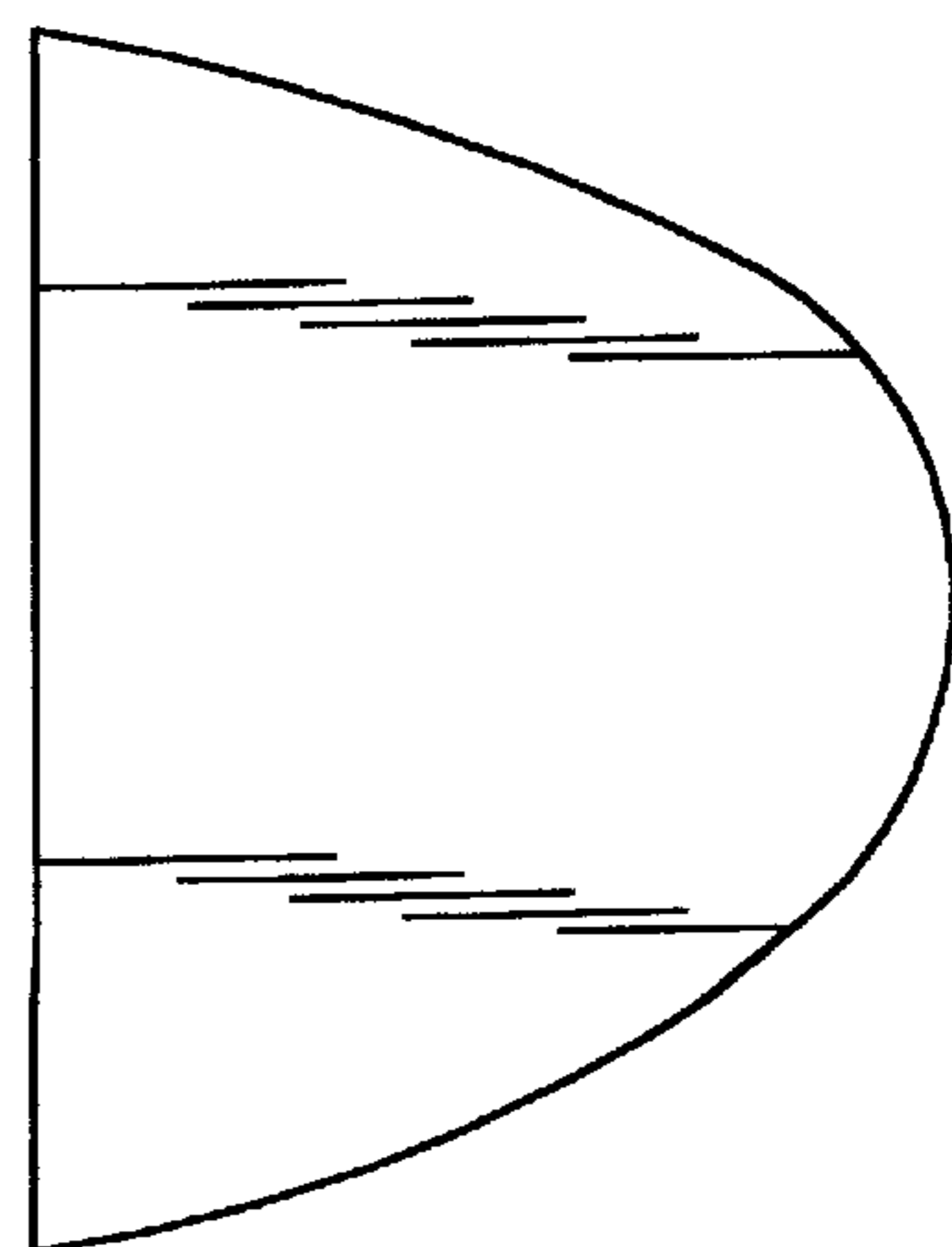

FIG. 8