



US00D437133S

(12) **United States Design Patent**
Yang

(10) **Patent No.:** **US D437,133 S**

(45) **Date of Patent:** **** Feb. 6, 2001**

(54) **ELECTRIC MASSAGE LOUNGER**

(75) **Inventor:** **Hong Lin Yang, Yung Ho (TW)**

(73) **Assignee:** **Taiwan Family Enterprise Co., Ltd.,
Taipei (TW)**

(**) **Term:** **14 Years**

(21) **Appl. No.:** **29/093,989**

(22) **Filed:** **Sep. 23, 1998**

(51) **LOC (7) Cl.** **06-01**

(52) **U.S. Cl.** **D6/367**

(58) **Field of Search** D6/334, 335, 336,
D6/360, 361, 367, 371, 373, 500-502;
297/68, 84, 85, 271.1-271.3, 423.1-423.3,
423.19; 601/49, 57-59, 97, 98

(56) **References Cited**

U.S. PATENT DOCUMENTS

D. 240,479	*	7/1976	Halme	D6/334
D. 336,167	*	6/1993	Yamasaki et al.	D6/367
D. 365,217	*	12/1995	Yamauchi et al.	D6/360
D. 372,800	*	8/1996	Yamasaki	D6/367
D. 372,801	*	8/1996	Fujimoto et al.	D6/367

D. 394,559	*	5/1998	Leventhal	D6/361
D. 402,479	*	12/1998	Inada	D6/361
D. 418,990	*	1/2000	Oguri et al.	D6/367
D. 423,236	*	4/2000	Palumbo	D6/334
D. 430,974	*	9/2000	Yang	D6/367

* cited by examiner

Primary Examiner—Doris V. Coles

Assistant Examiner—Mimosa De

(74) *Attorney, Agent, or Firm*—Pro-Techtor International Services

(57) **CLAIM**

The ornamental design for an electric massage lounger, as shown.

DESCRIPTION

FIG. 1 is a front elevational view of an electric massage lounger showing my new design;
FIG. 2 is a rear elevational view thereof;
FIG. 3 is a left side elevational view thereof;
FIG. 4 is a right side elevational view thereof;
FIG. 5 is a top plan view thereof;
FIG. 6 is a bottom plan view thereof; and,
FIG. 7 is a top, right, front, perspective view thereof.

1 Claim, 4 Drawing Sheets

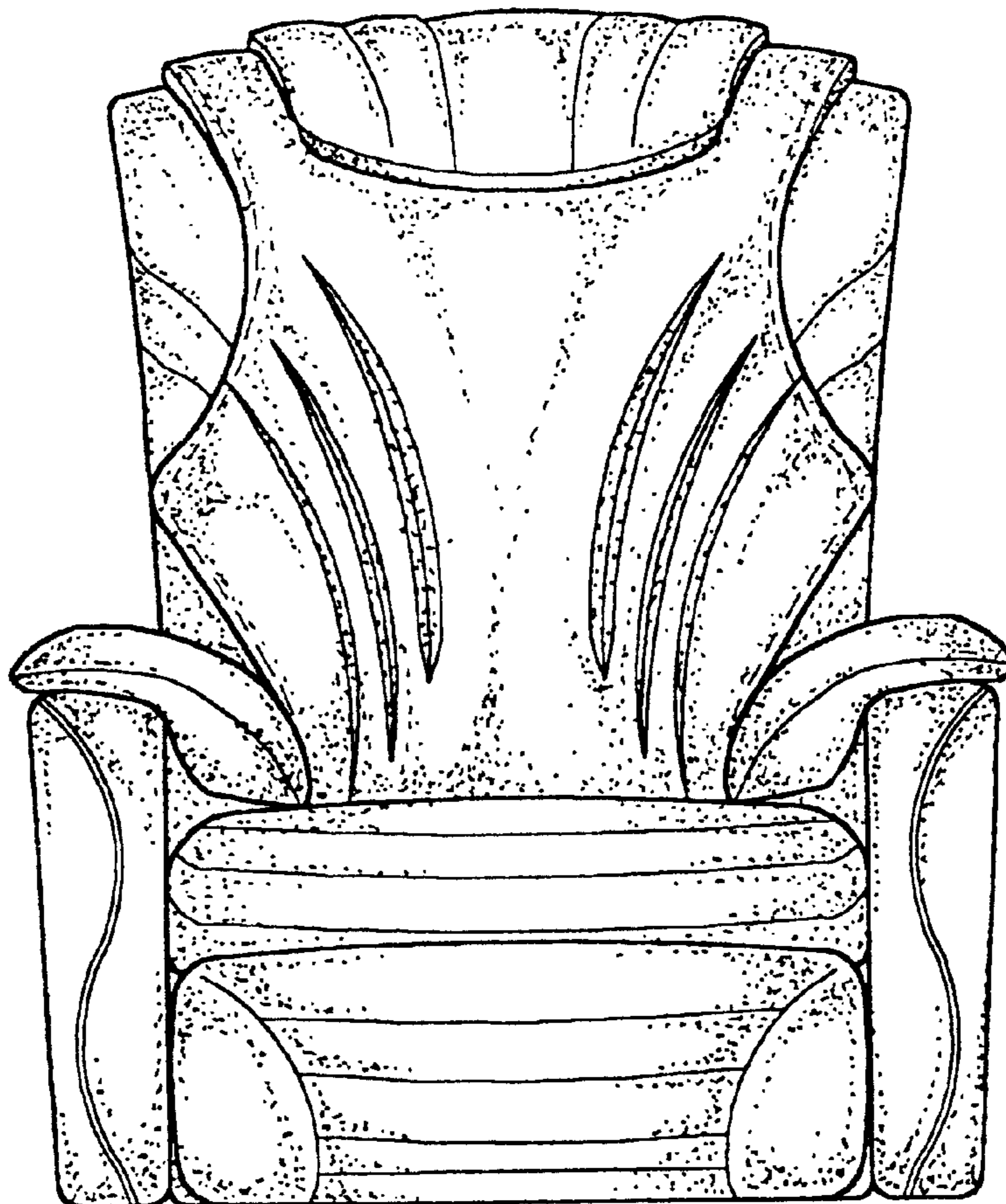

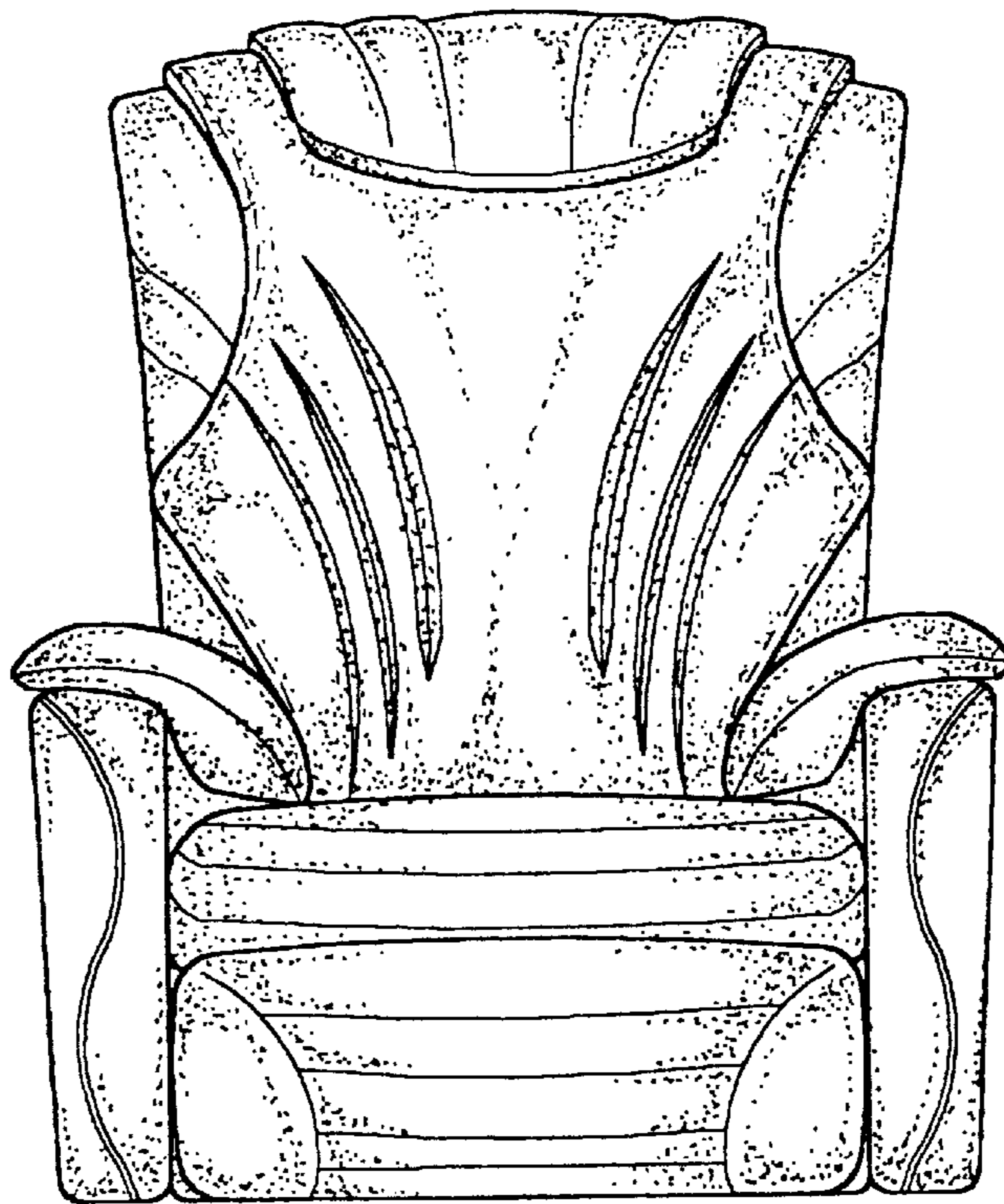

Fig. 1

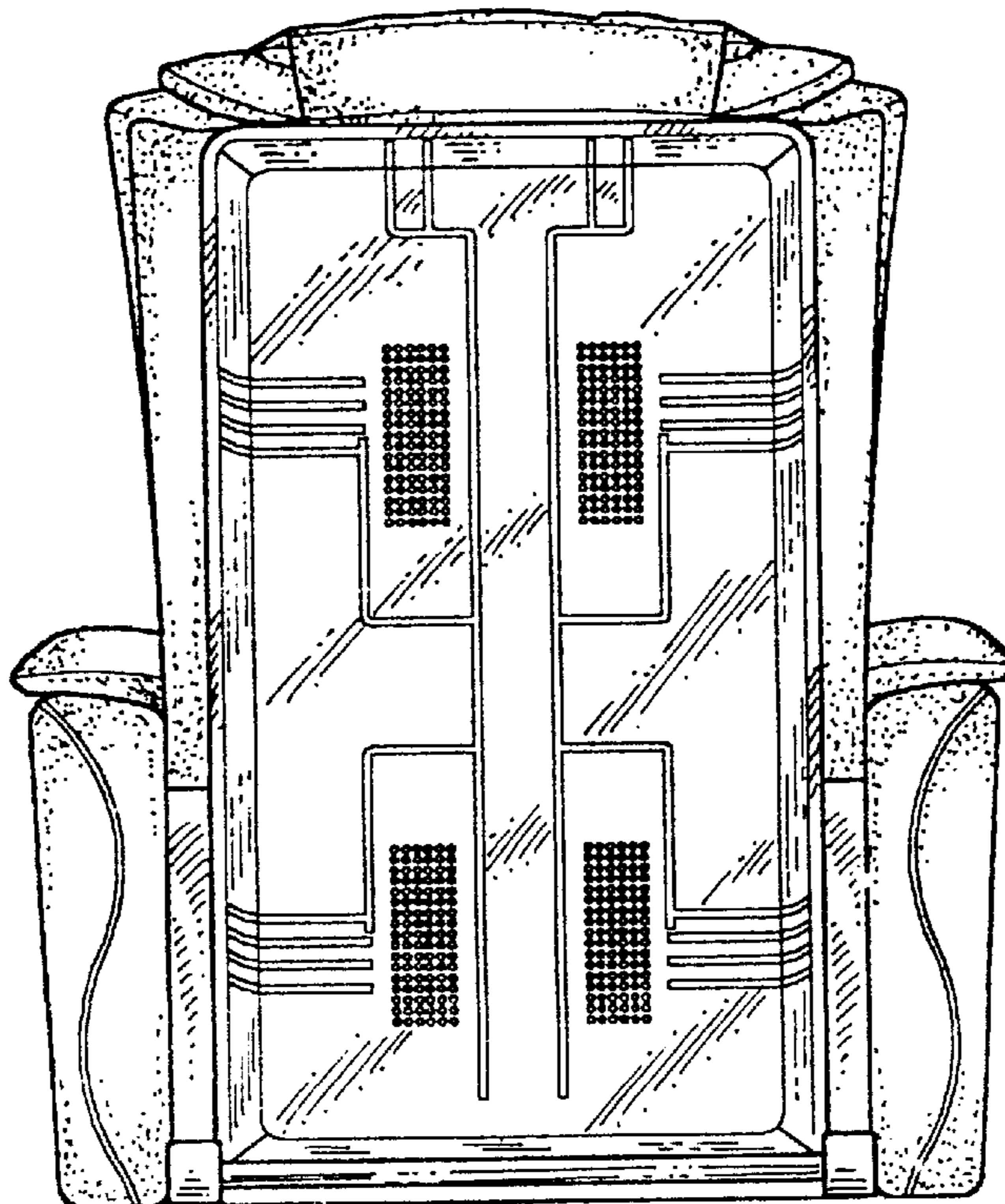

Fig. 2

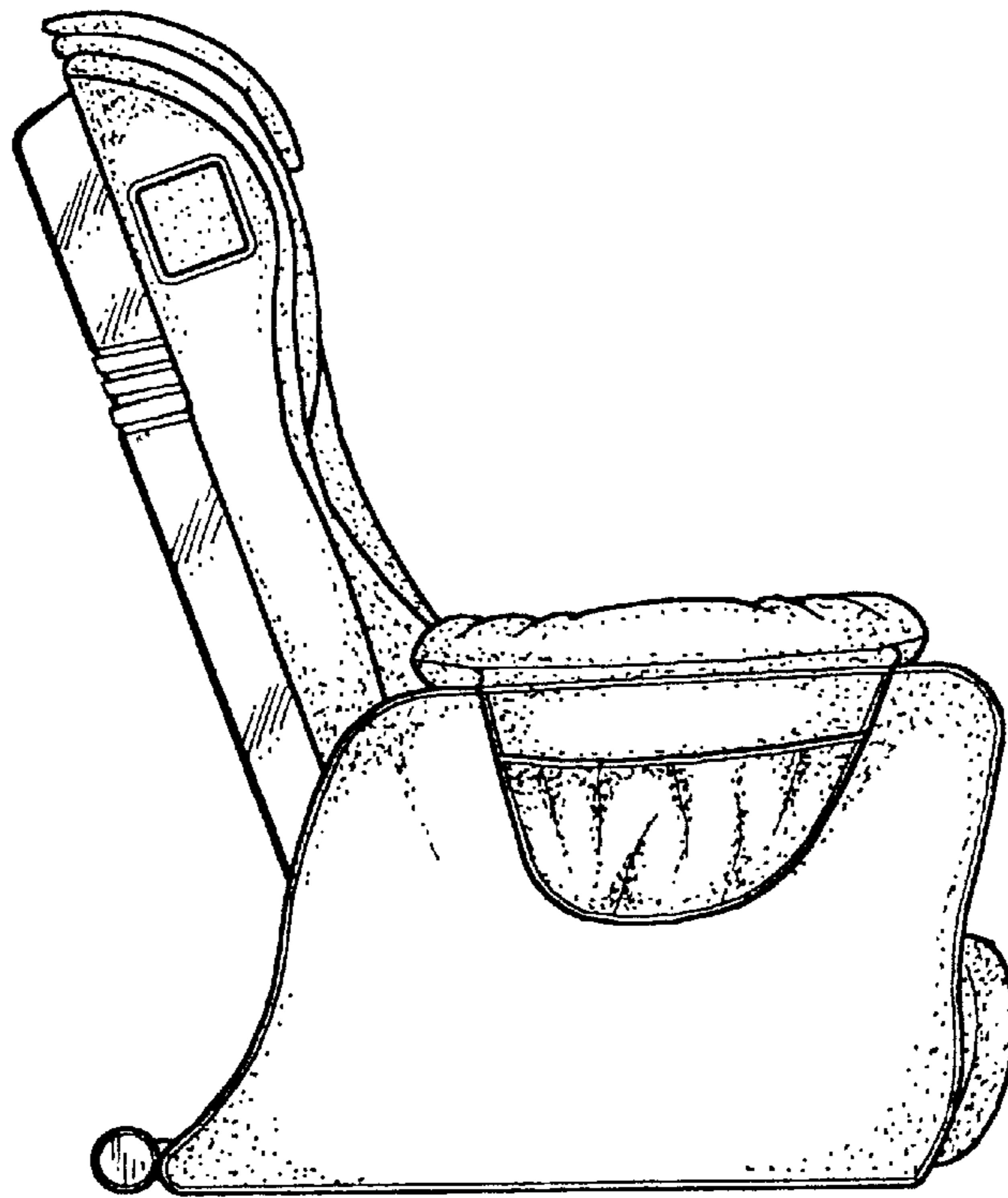

Fig. 3

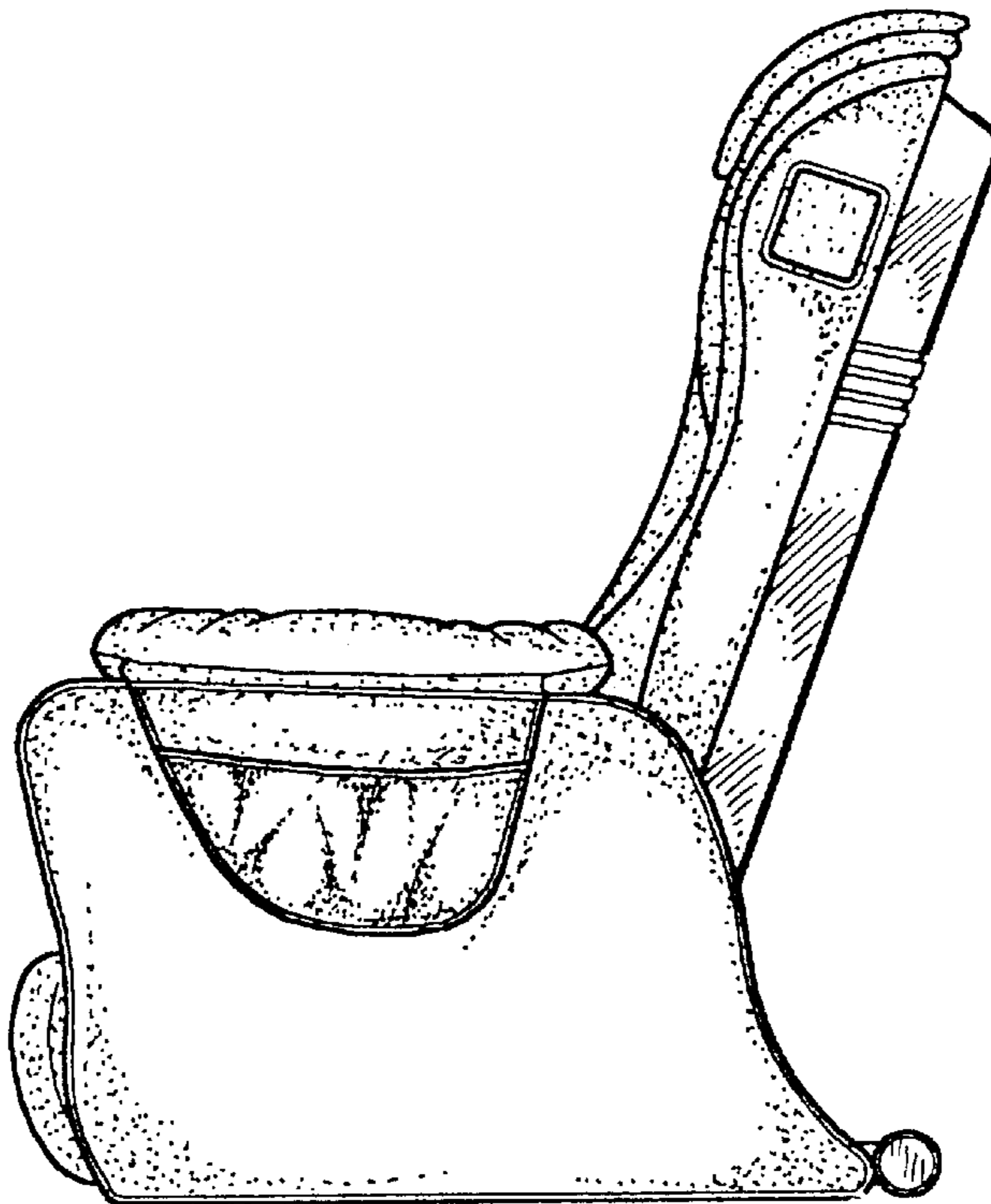

Fig. 4

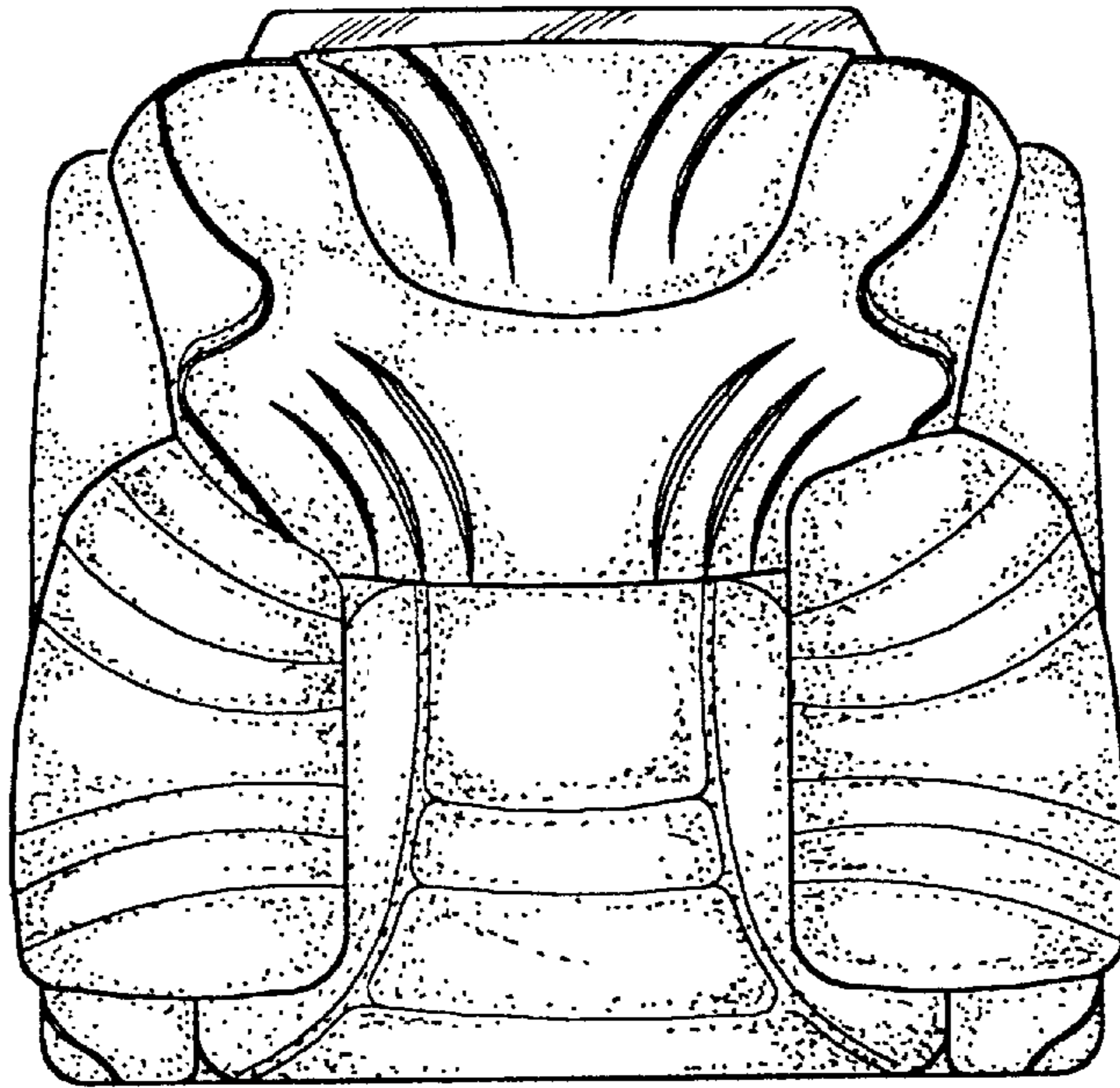

Fig. 5

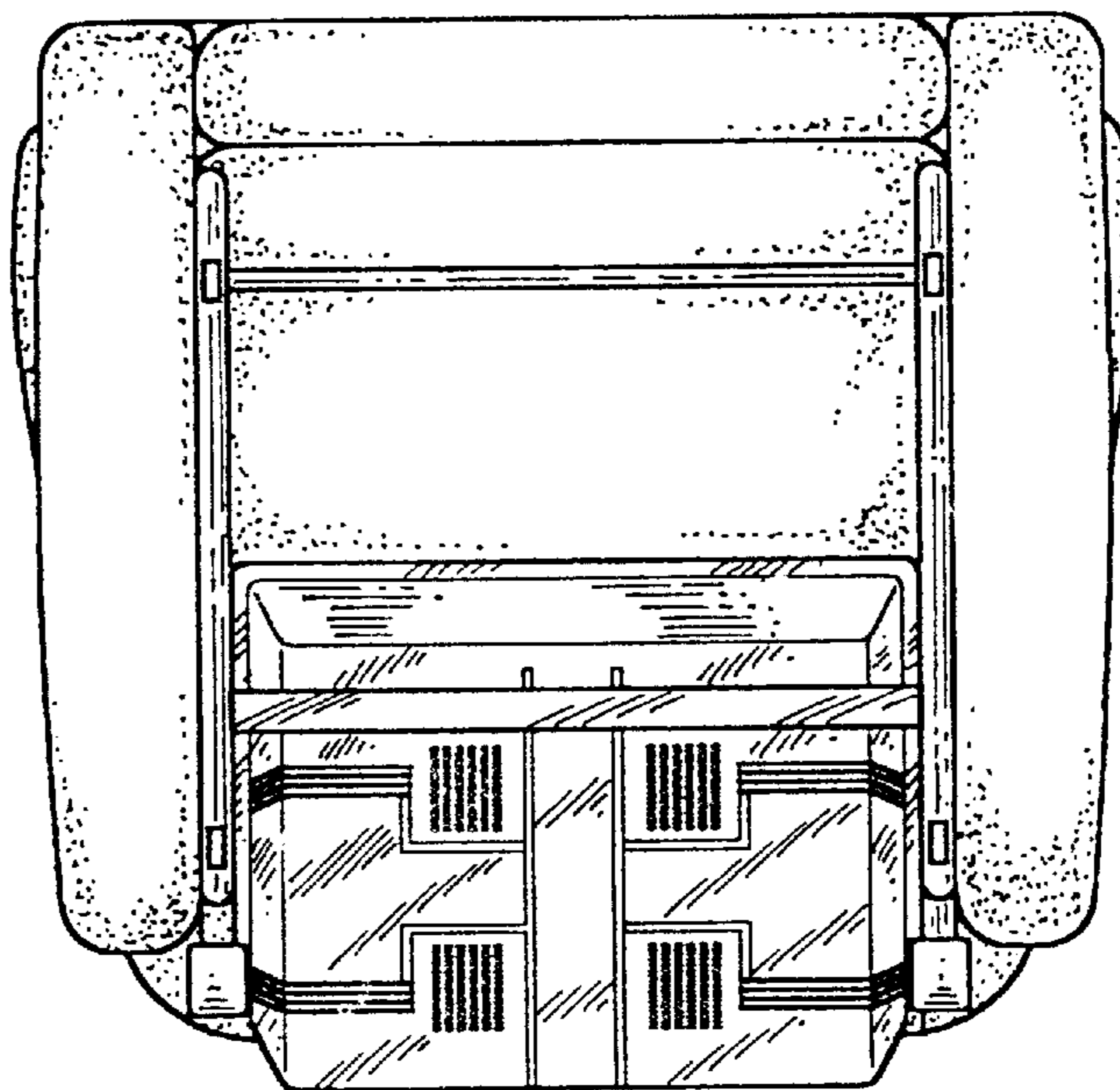

Fig. 6

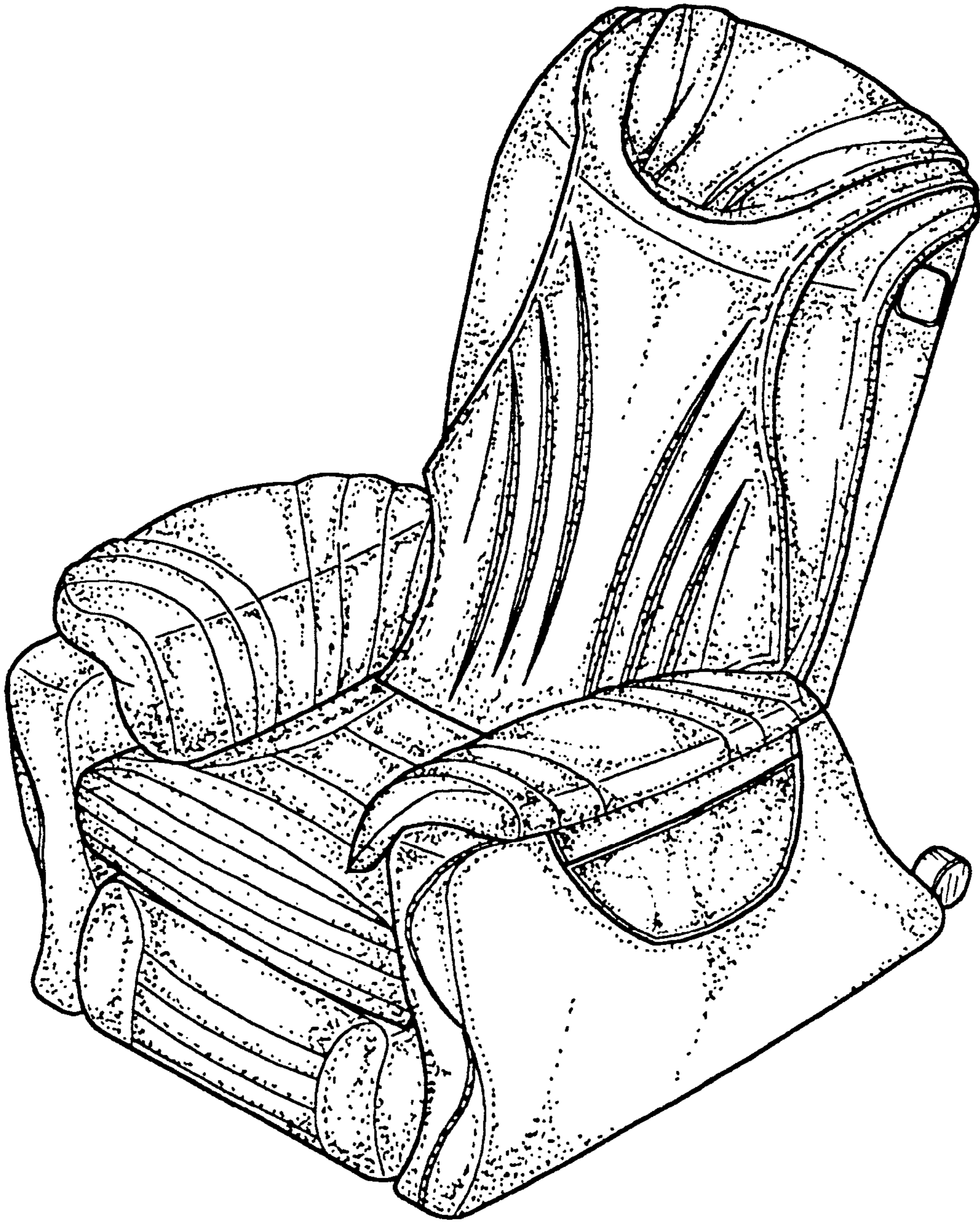

Fig. 7