



US00D437096S

(12) **United States Design Patent**
Julien

(10) **Patent No.:** **US D437,096 S**

(45) **Date of Patent:** **** Jan. 30, 2001**

(54) **COMBINATION DISH RACK AND COVER**

(76) Inventor: **Helene C. Julien**, 40 E. Division Ave.,
Spring Valley, NY (US) 10977

(**) Term: **14 Years**

(21) Appl. No.: **29/114,216**

(22) Filed: **Nov. 22, 1999**

(51) **LOC (7) Cl.** **07-05**

(52) **U.S. Cl.** **D32/55**

(58) **Field of Search** D32/55, 56; 220/571,
220/572, 487

(56) **References Cited**

U.S. PATENT DOCUMENTS

D. 394,924	*	6/1998	Julien	D32/55
D. 407,879	*	4/1999	Gunawan	D32/55
3,476,282	*	11/1969	Monaco et al.	220/23.6
5,158,184	*	10/1992	Craft et al.	D32/55

* cited by examiner

Primary Examiner—Robin V. Taylor

(57) **CLAIM**

The ornamental design for a combination dish rack and cover, as shown and described.

DESCRIPTION

FIG. 1 is a front elevational view of the combination dish rack and cover illustrating the first embodiment of my design.

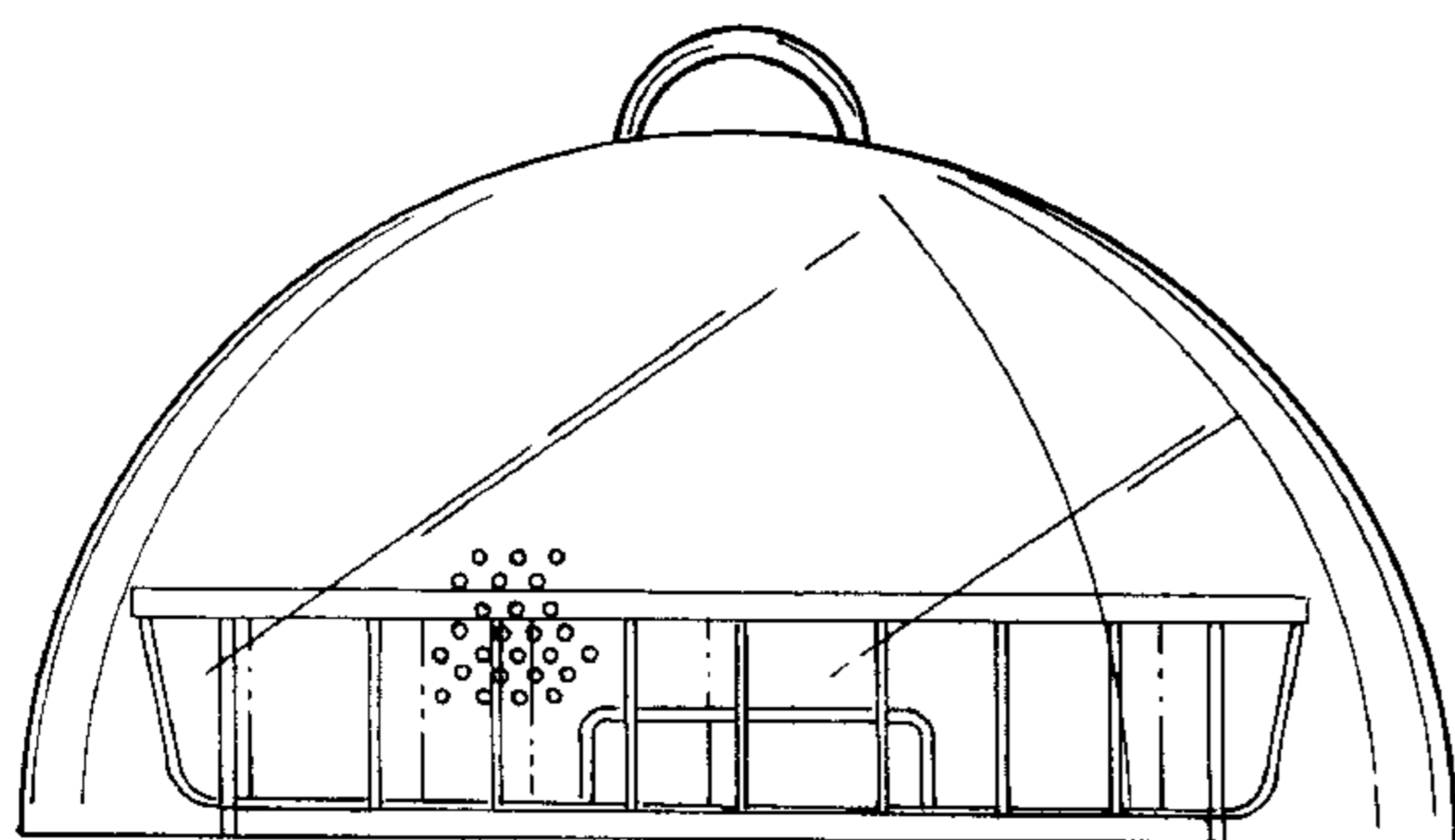

FIG. 2 is a rear elevational view thereof.

FIG. 3 is a right side view thereof showing my design in operation and use and containing items to be dried.

FIG. 4 is a cross sectional left side view of my design taken along line 4—4 of FIG. 1.

FIG. 5 is a top plan view thereof showing my design in operation and use and containing items to be dried.

FIG. 6 is a bottom view thereof similar to FIG. 5.

FIG. 7 is a top plan view of a second embodiment of my design wherein the cover is not dome shaped but rather rectilinear in configuration.

FIG. 8 is a bottom view of the second embodiment of my design similar to FIG. 7.

FIG. 9 is a front elevational view of the second embodiment of my design.

FIG. 10 is a rear elevational view of the second embodiment of my design.

FIG. 11 is a right side view of the second embodiment of my design showing my design in operation and use and containing items to be dried; and,

FIG. 12 is a cross sectional view of the second embodiment of my design taken along line 12—12 of FIG. 9.

Note should be taken that the small holes shown in the cover are small drying holes. These holes are present over and extend through the entire surface of the cover, but are shown on only a small portion for illustrative purposes.

The broken line showing is for illustrative purposes only and forms no part of the claimed design.

1 Claim, 6 Drawing Sheets

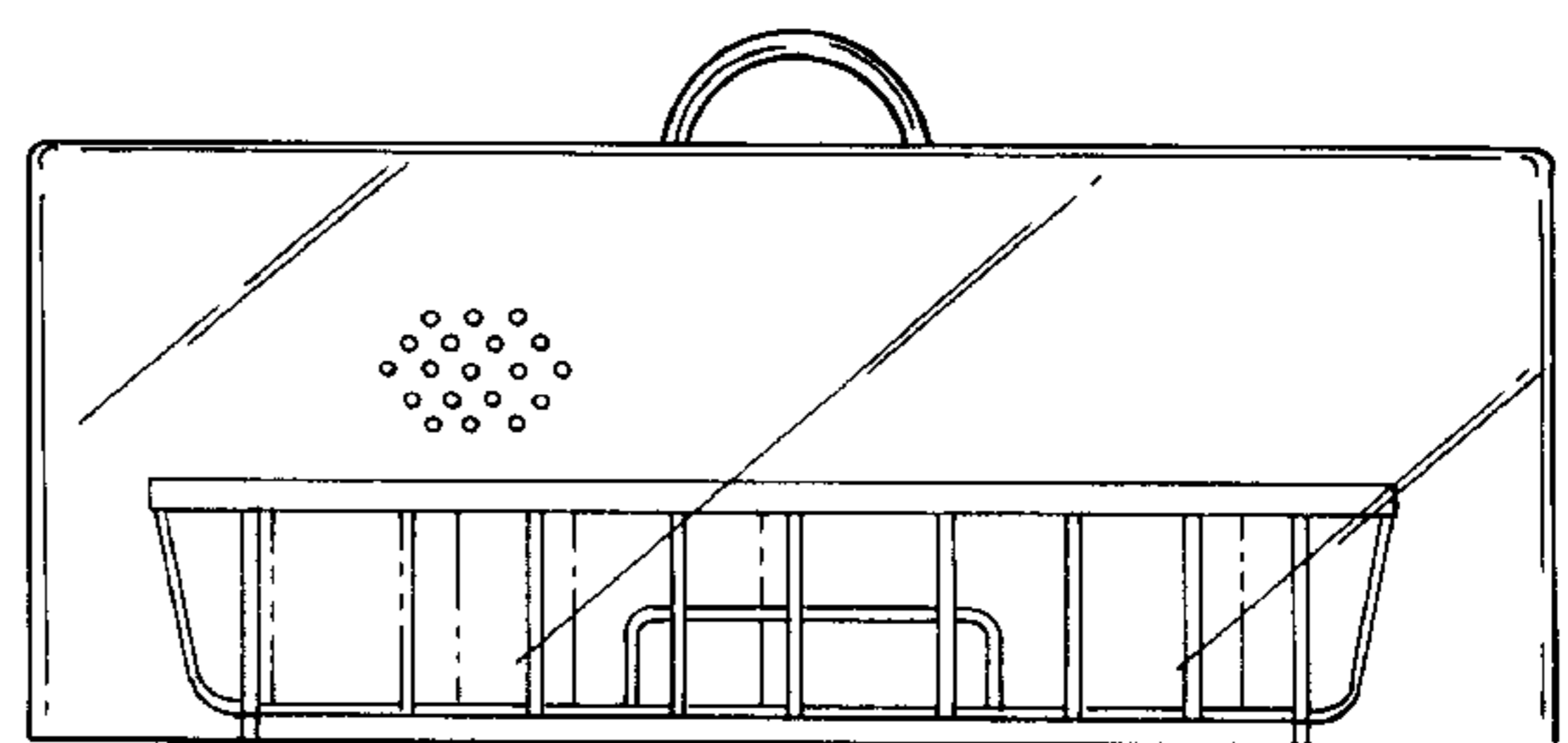

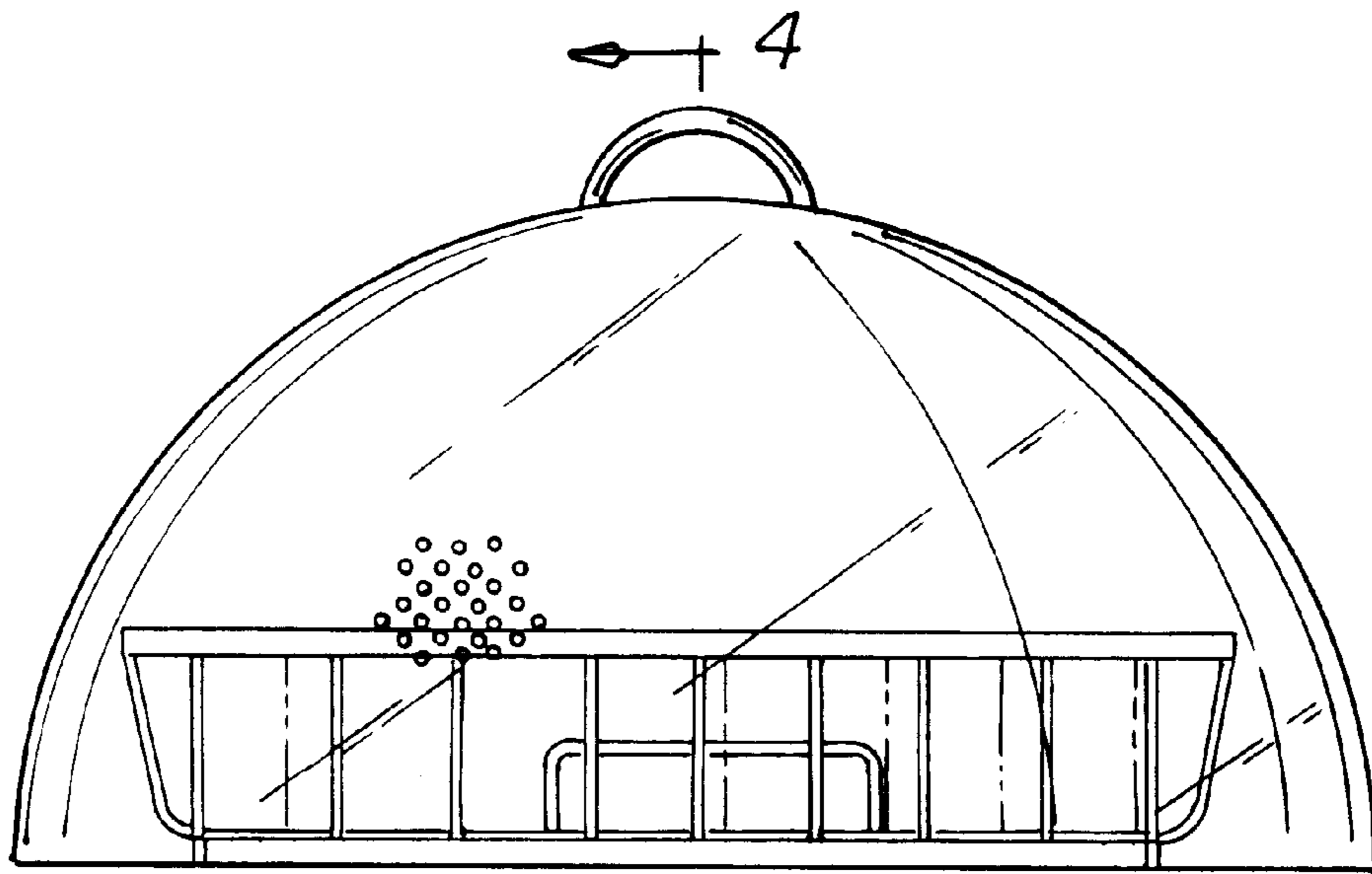

FIG. 1

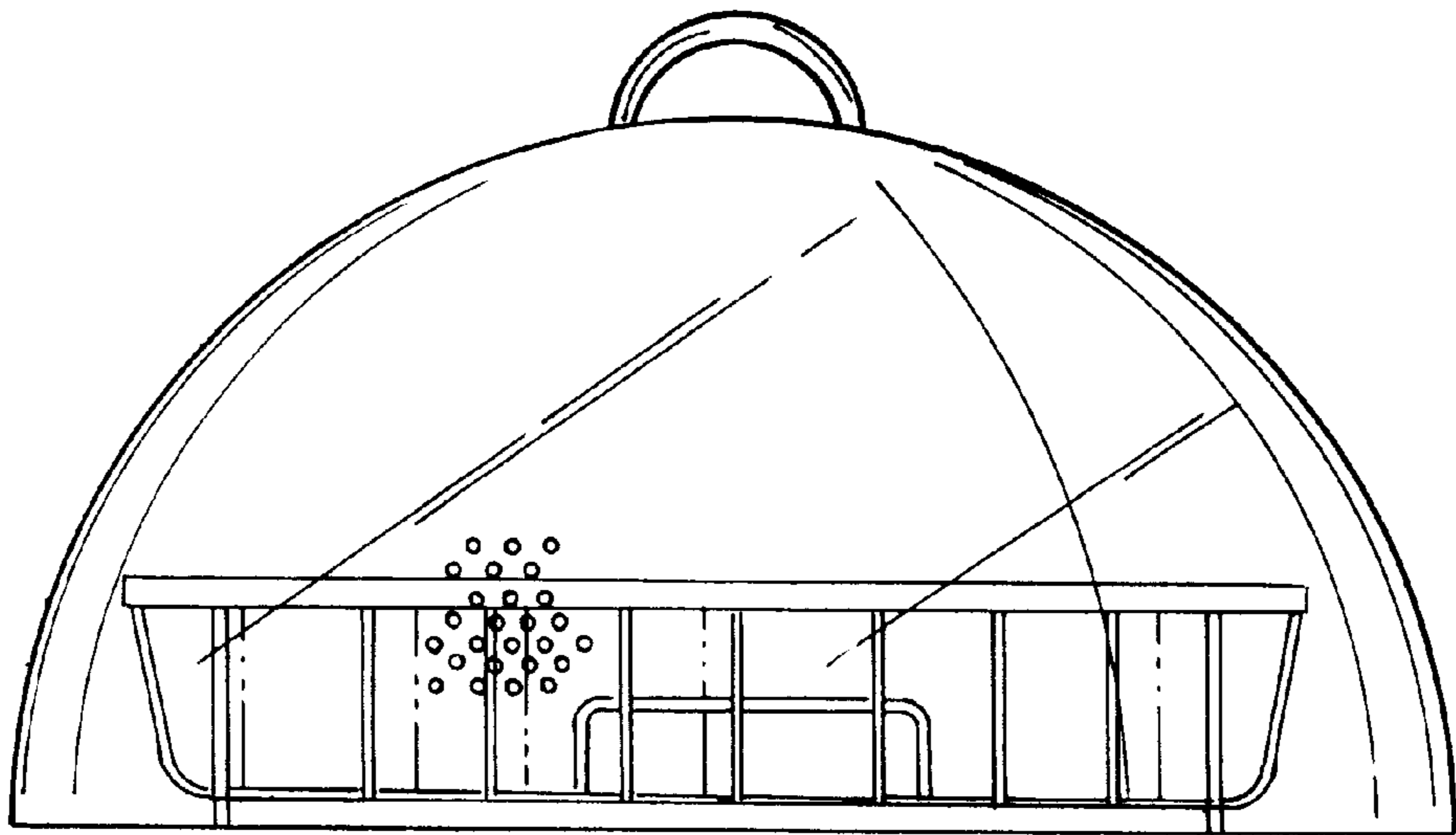

FIG. 2

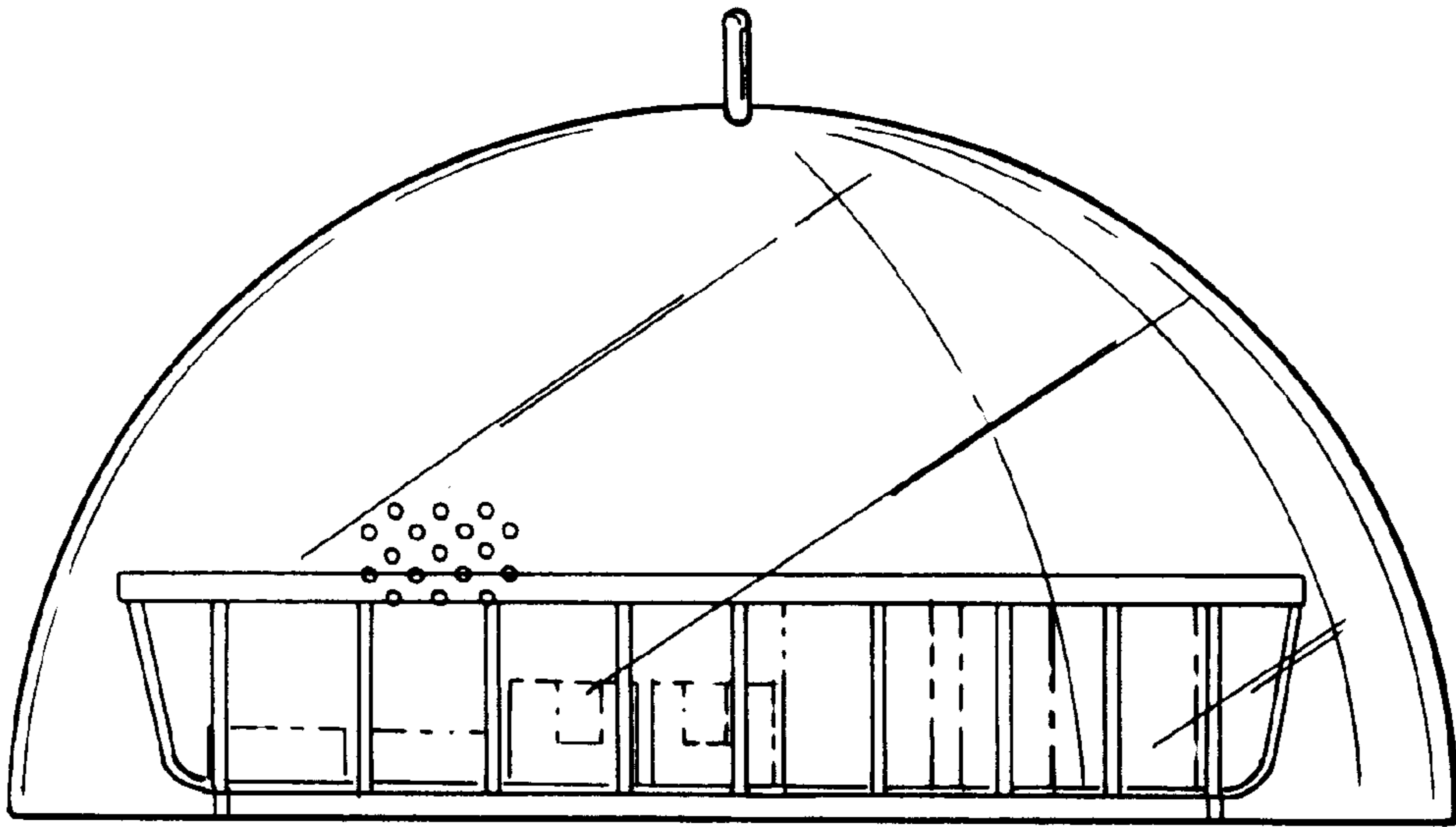

FIG. 3

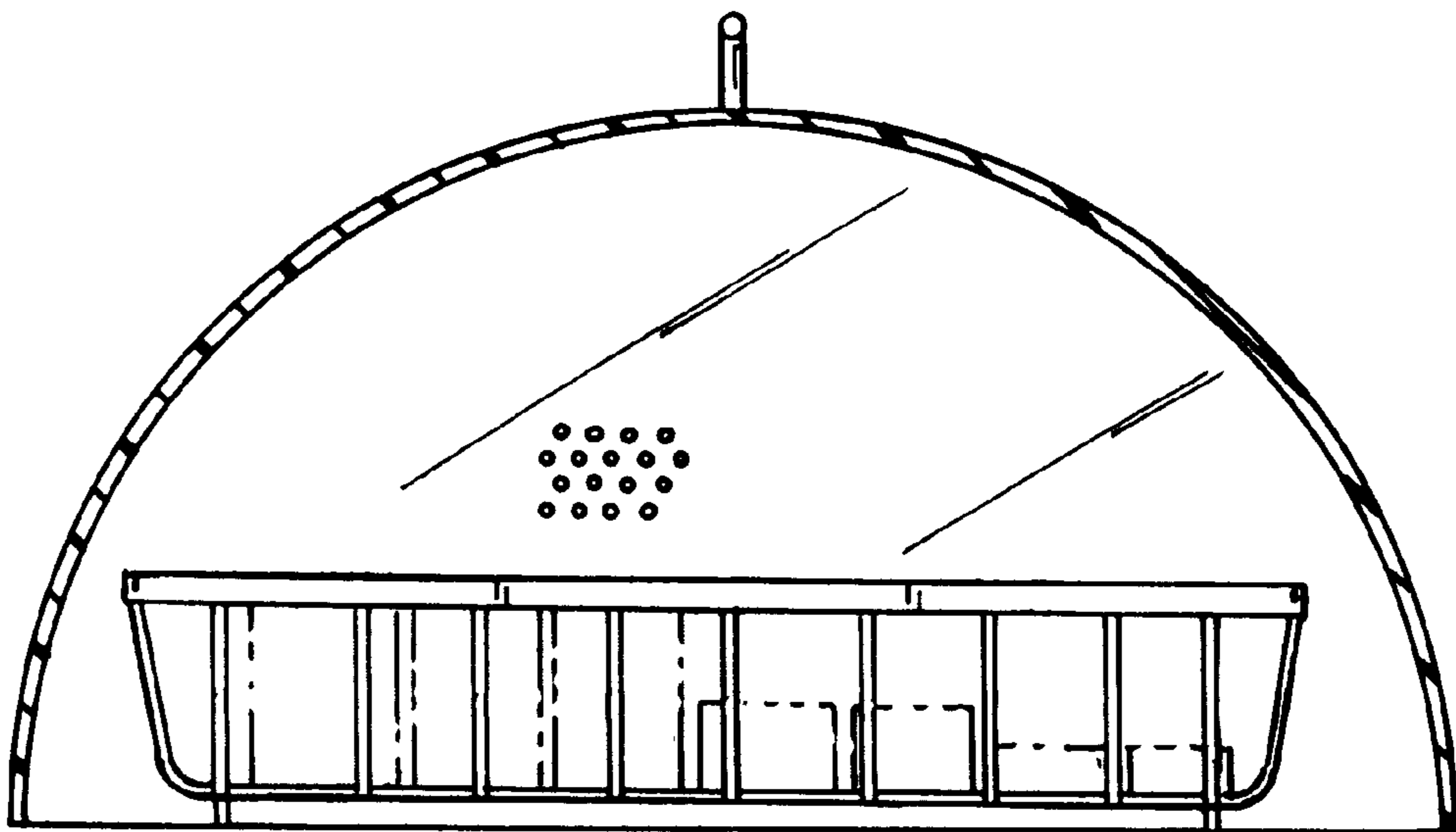

FIG. 4

FIG. 5

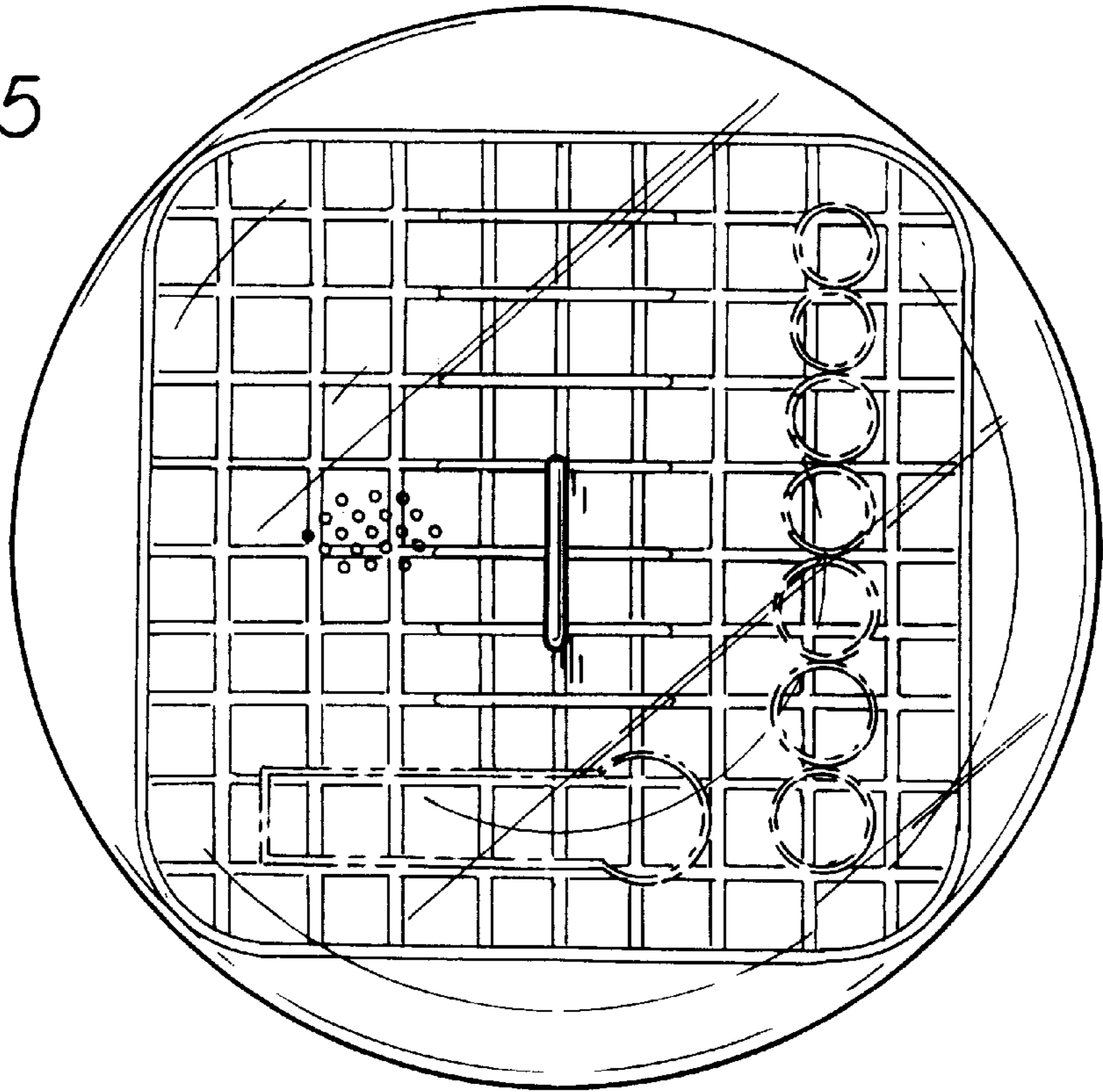

FIG. 6

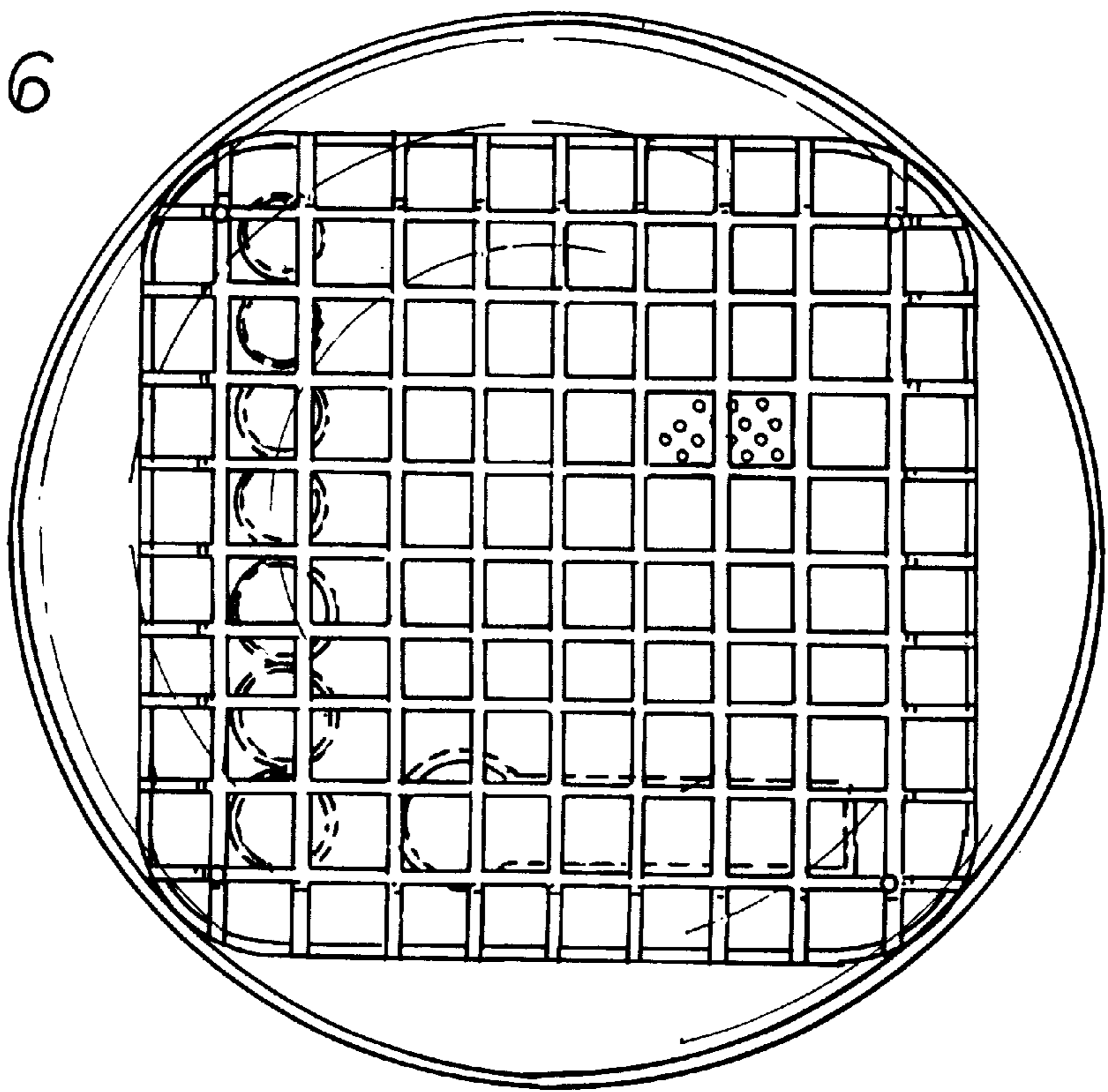

FIG 7

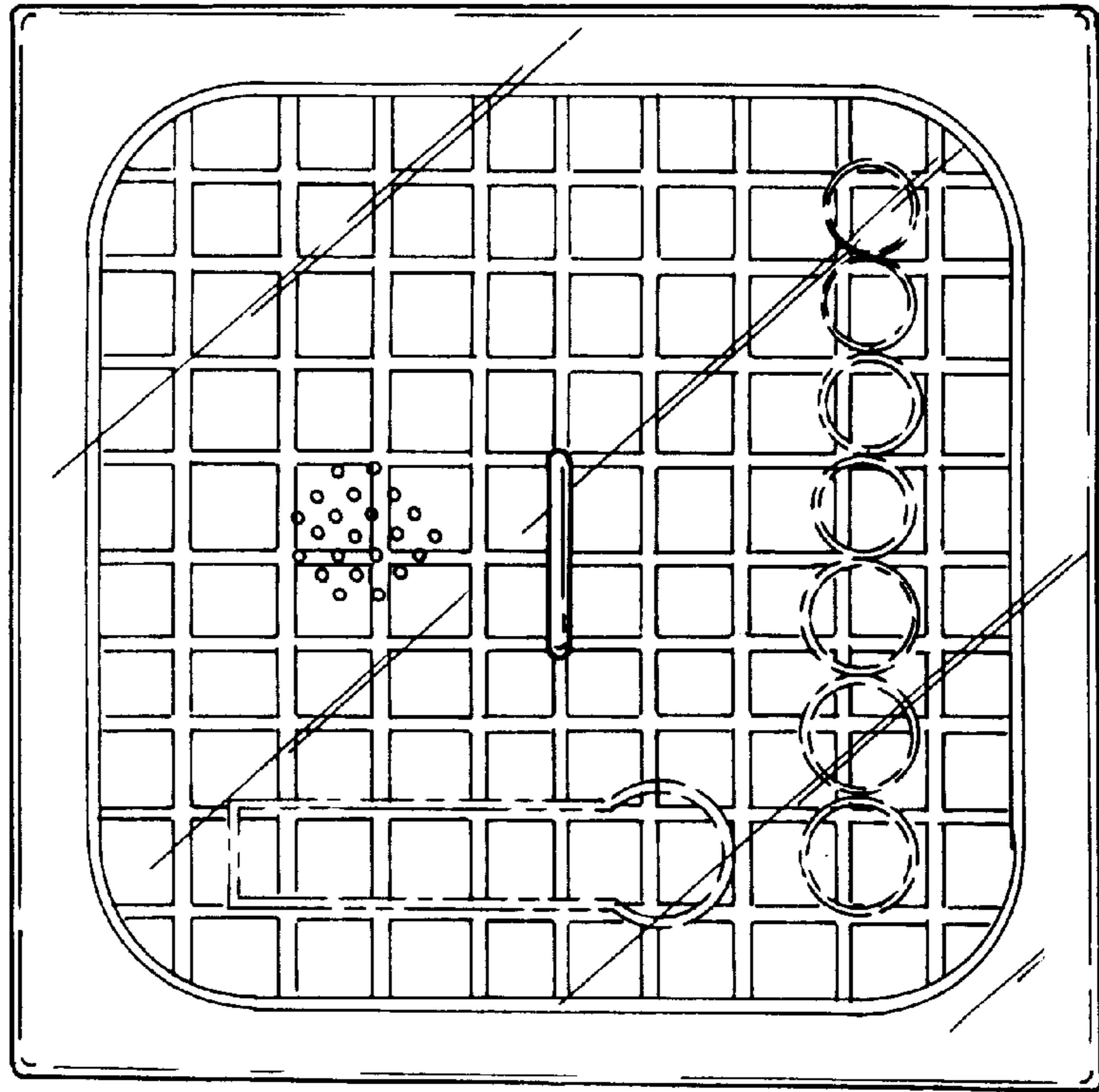
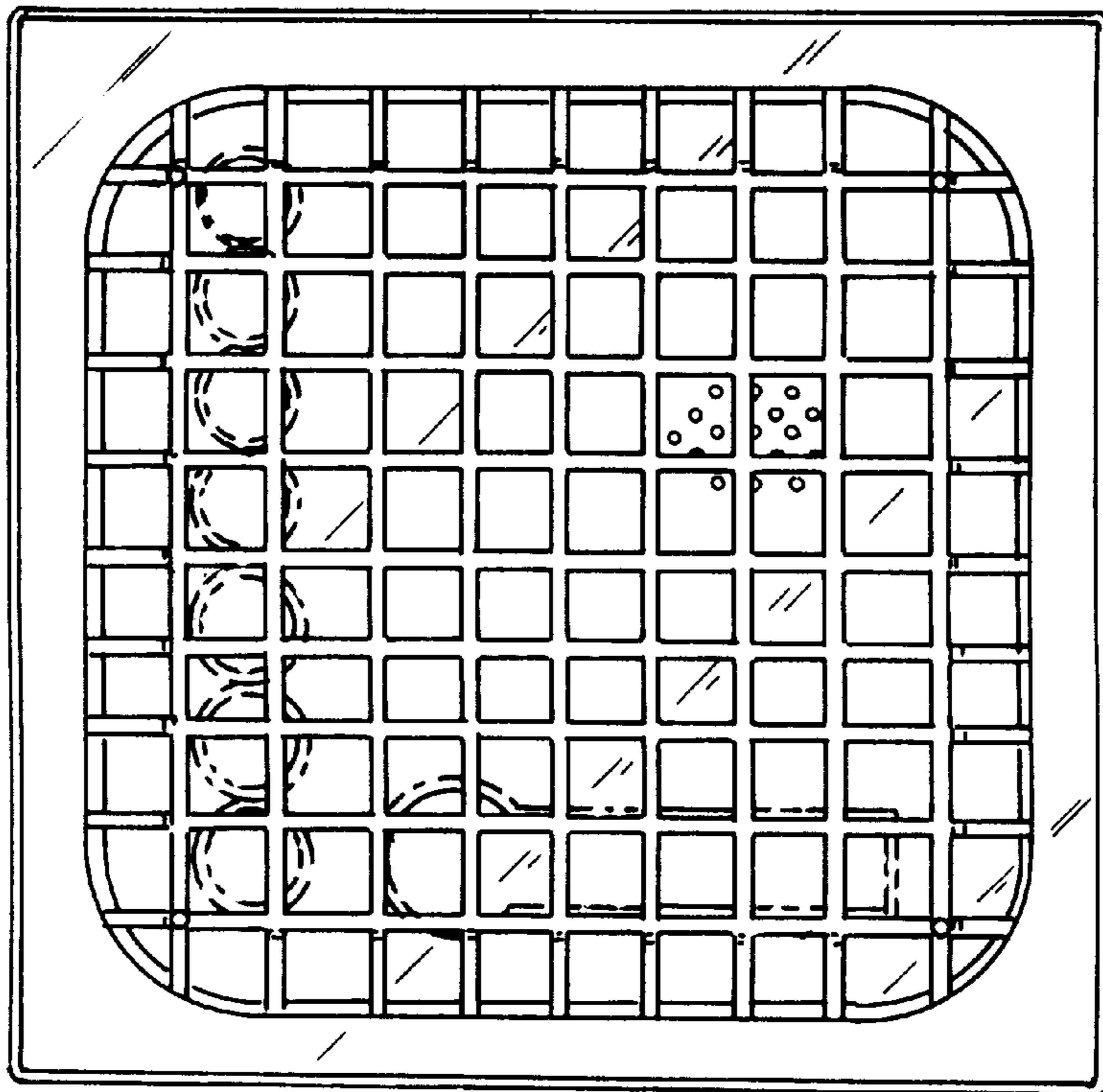
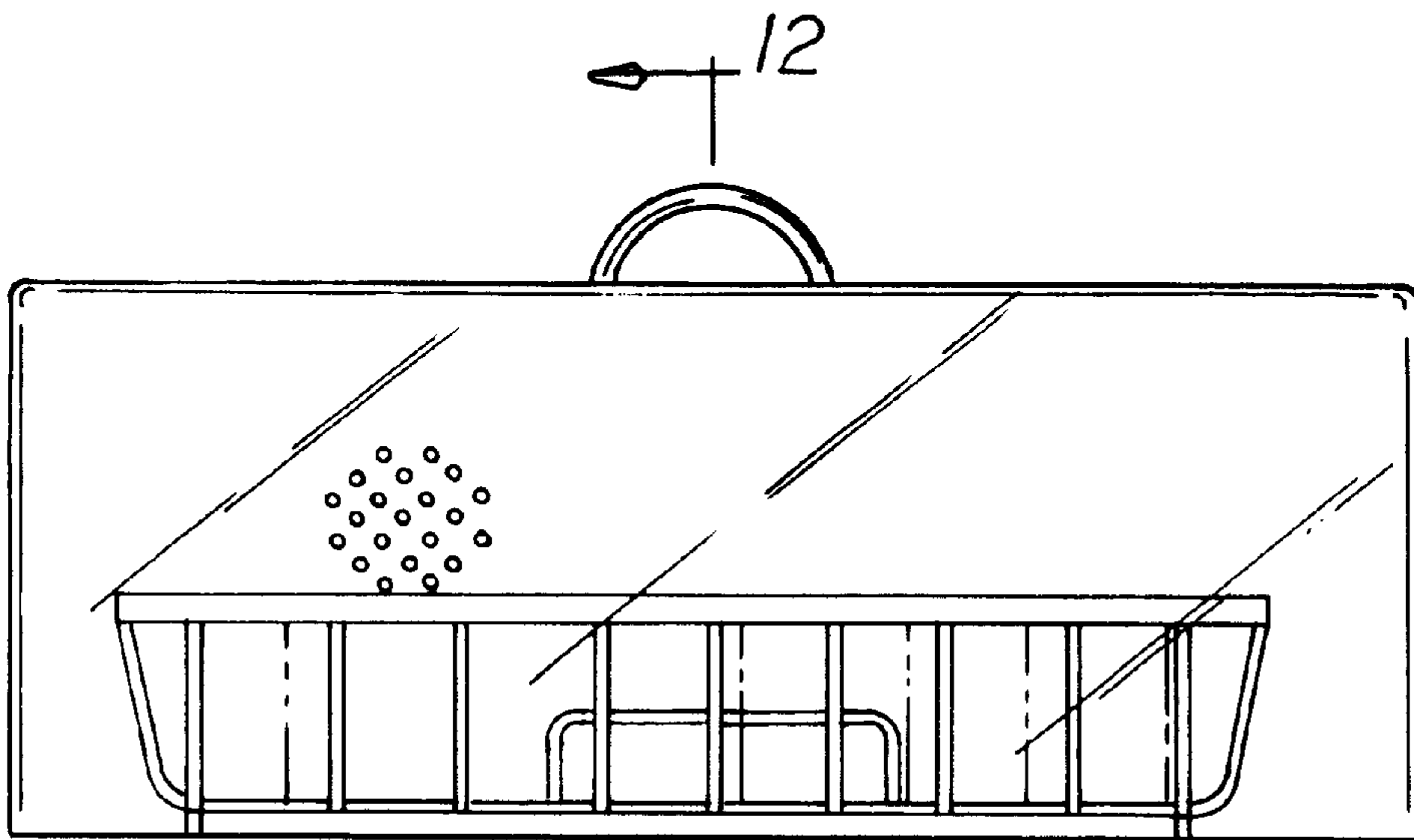

FIG 8





12
FIG 9

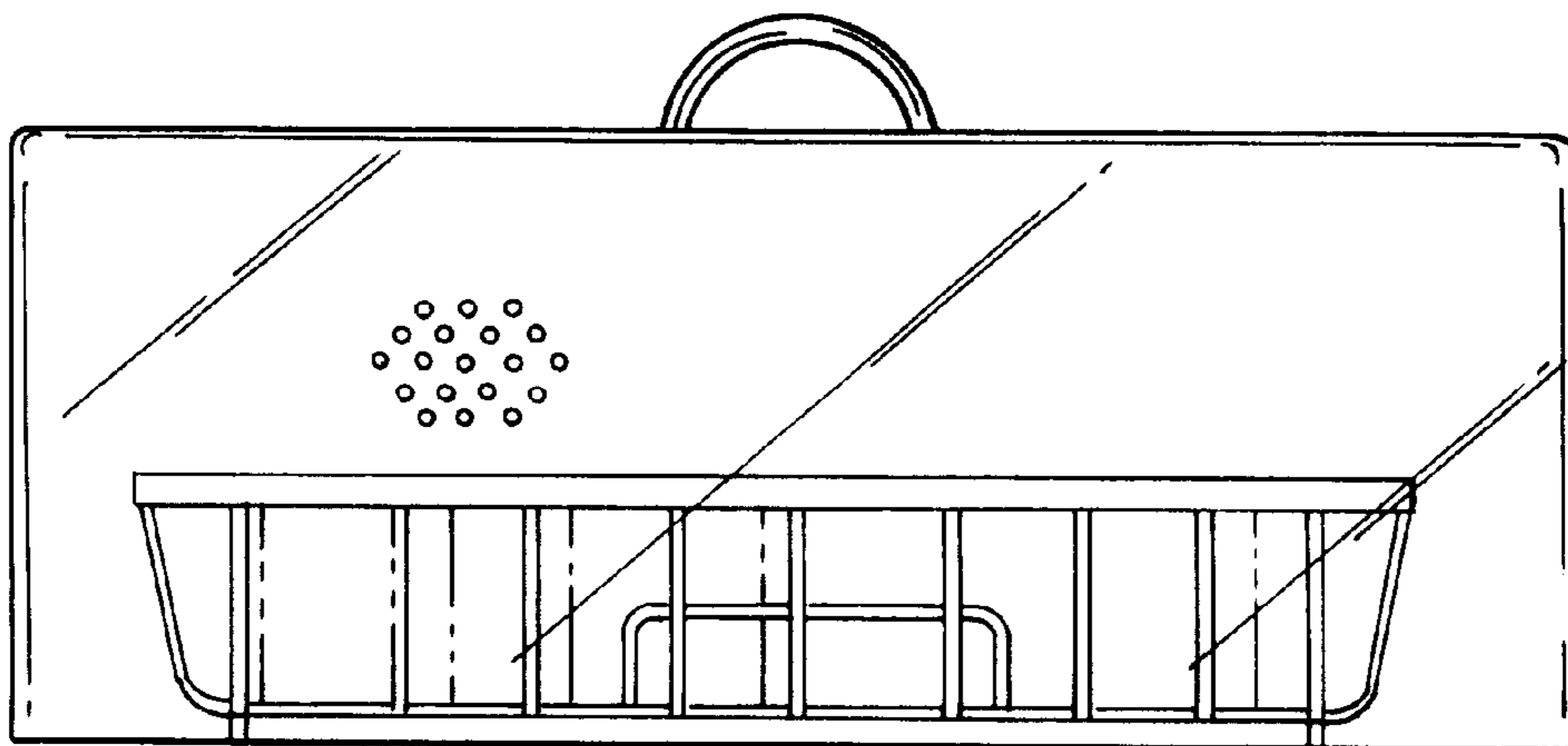

FIG 10

FIG 11

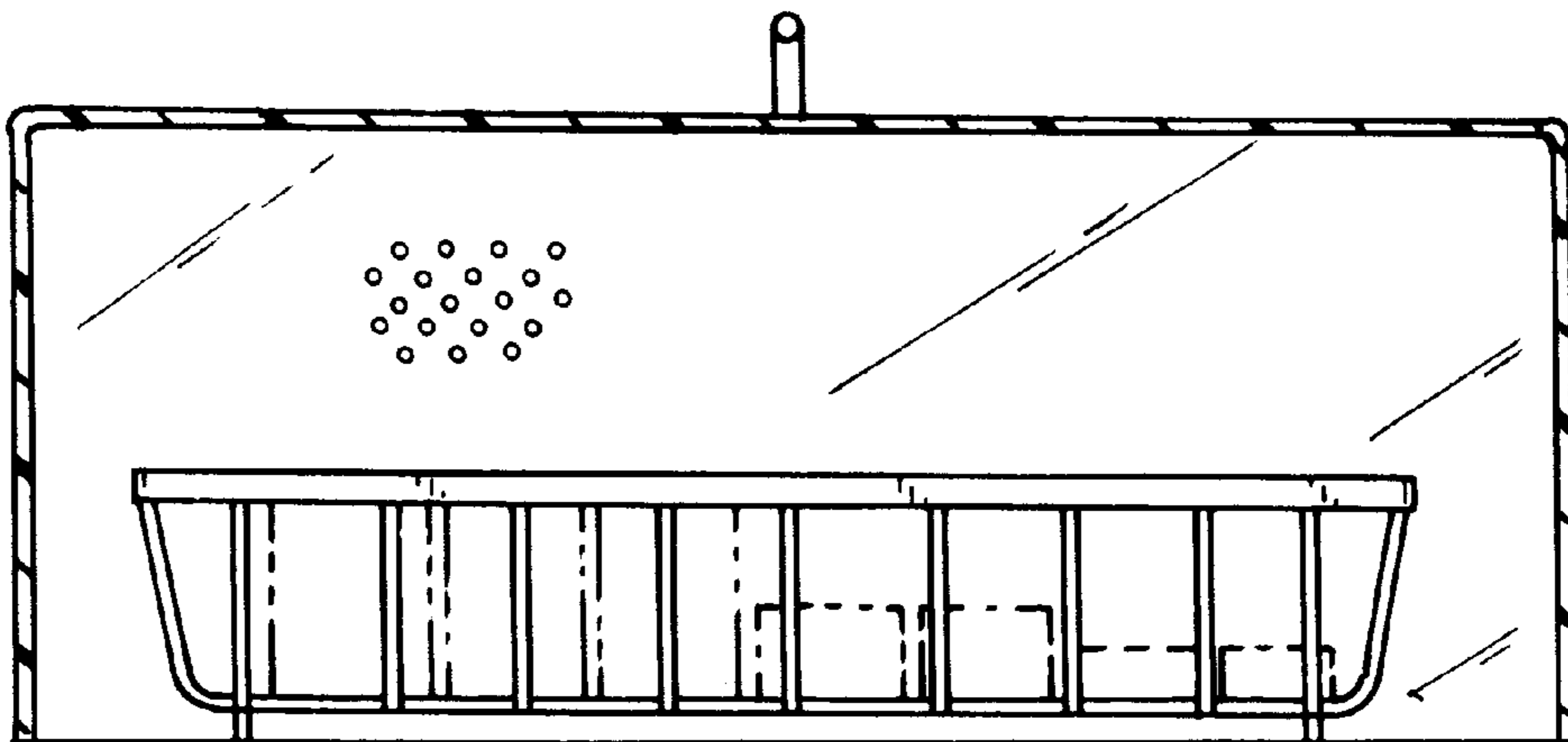
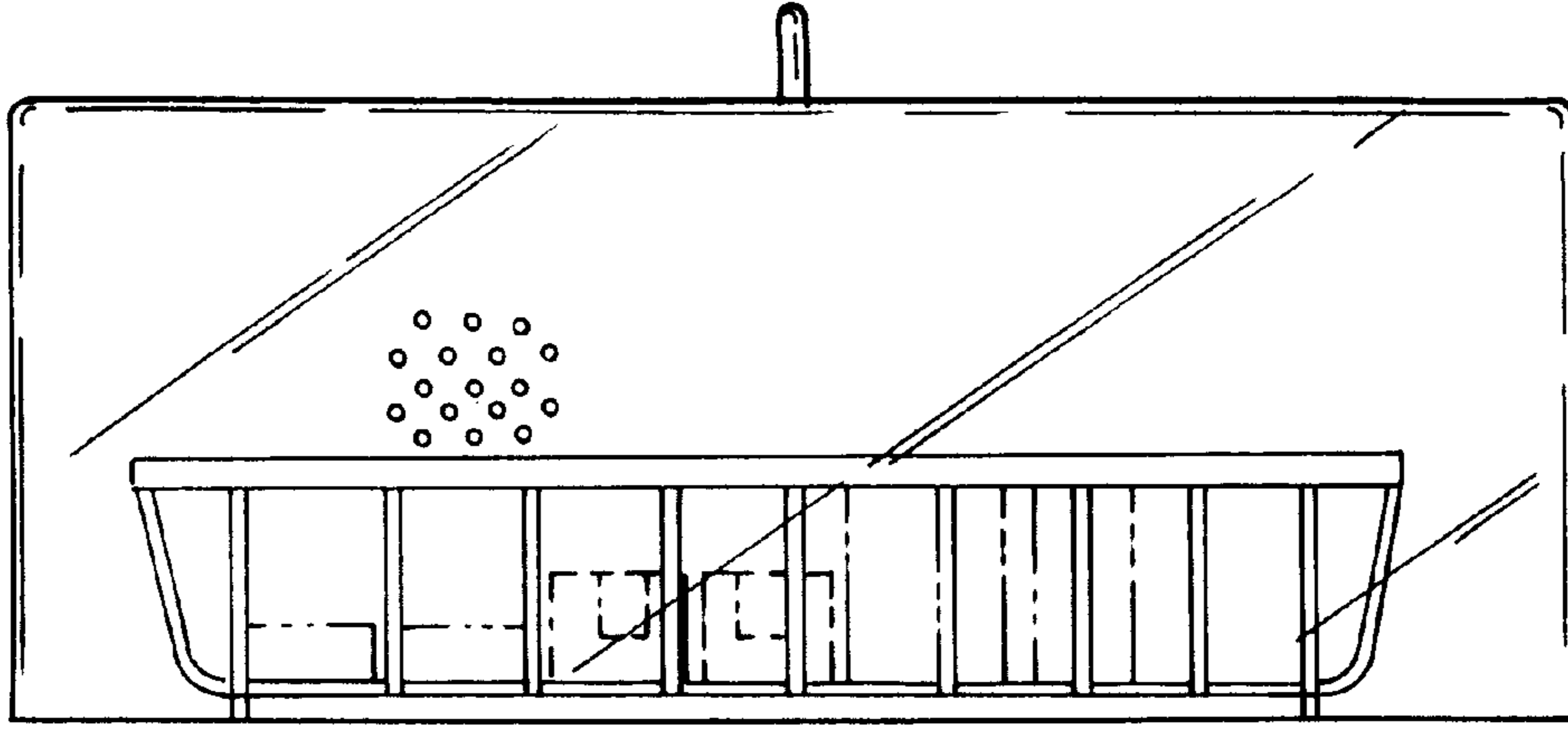

FIG 12