



US00D437079S

(12) **United States Design Patent**  
**Vodhanel, Jr.**

(10) **Patent No.:** **US D437,079 S**

(45) **Date of Patent:** **\*\* Jan. 30, 2001**

(54) **TABLE LAMP**

*Primary Examiner*—Alan P. Douglas

*Assistant Examiner*—Linda Brooks

(76) **Inventor:** **Joseph J Vodhanel, Jr.**, 10937 S.  
Groveland Ave., Whittier, CA (US)  
90603

(57) **CLAIM**

(\*\*) **Term:** **14 Years**

The ornamental design for a table lamp, as shown and described.

(21) **Appl. No.:** **29/124,891**

**DESCRIPTION**

(22) **Filed:** **Jun. 13, 2000**

FIG. 1 is a top plan view of a table lamp showing my design;

(51) **LOC (7) Cl.** ..... **26-03**

FIG. 2 is a left side elevational view; the right side elevational view is a mirror image of the left side thereof;

(52) **U.S. Cl.** ..... **D26/106**

FIG. 3 is a front elevational view thereof;

(58) **Field of Search** ..... D26/93–112; D62/410–414

FIG. 4 is a rear elevational view thereof;

(56) **References Cited**

FIG. 5 is a bottom plan view thereof;

**U.S. PATENT DOCUMENTS**

FIG. 6 is a cross sectional view taken along lines 6—6 of FIG. 3 thereof; and,

D. 244,793 \* 6/1977 Ruud ..... D26/108

FIG. 7 is a front perspective view thereof.

D. 245,367 \* 8/1977 Franck ..... D26/111

FIGS. 1–6 are shown without the lamp shade for clarity of illustration.

D. 391,005 \* 2/1998 Gunthert ..... D26/110

D. 394,326 \* 5/1998 Littman et al. .... D26/106

\* cited by examiner

**1 Claim, 2 Drawing Sheets**

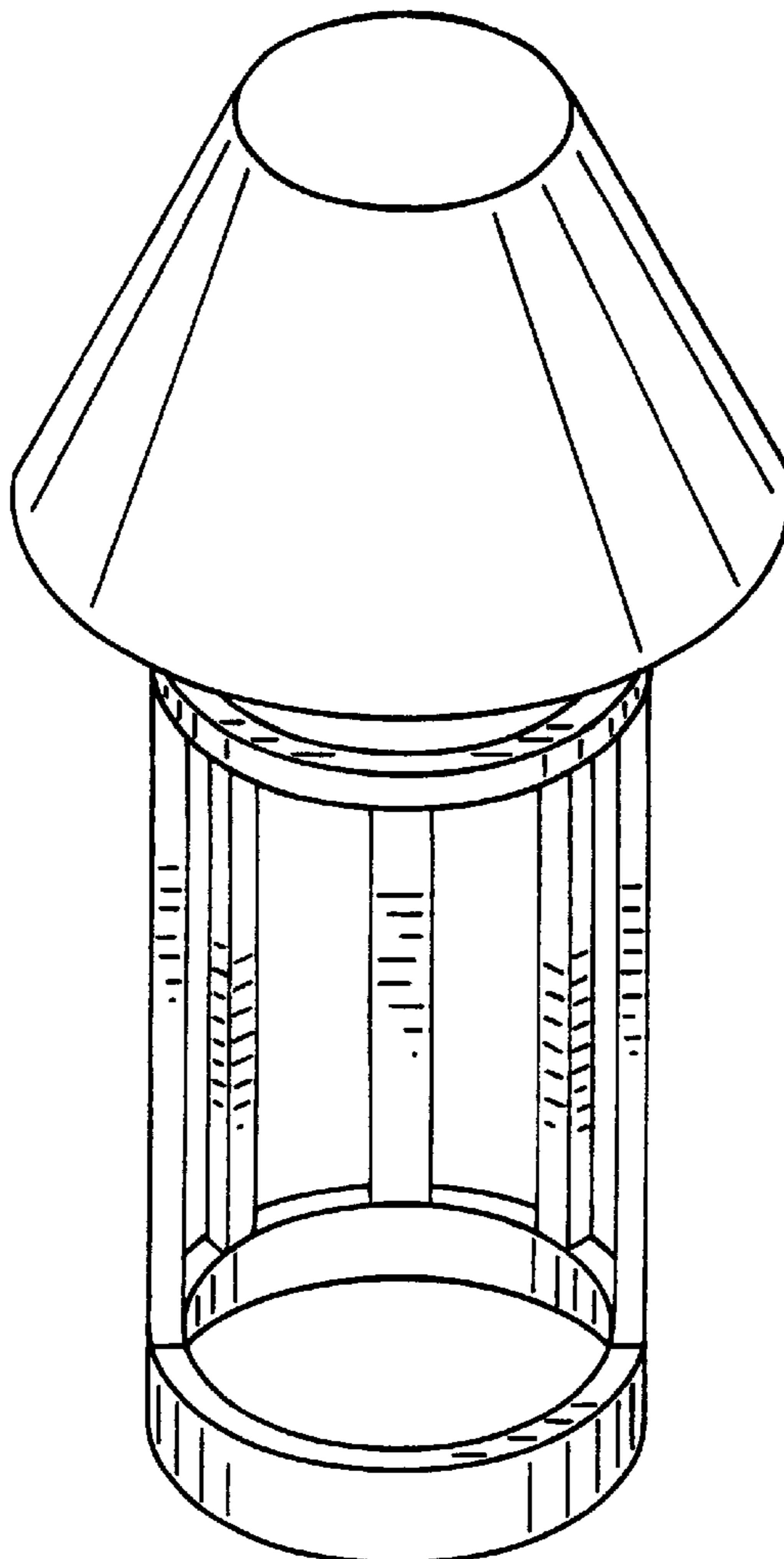

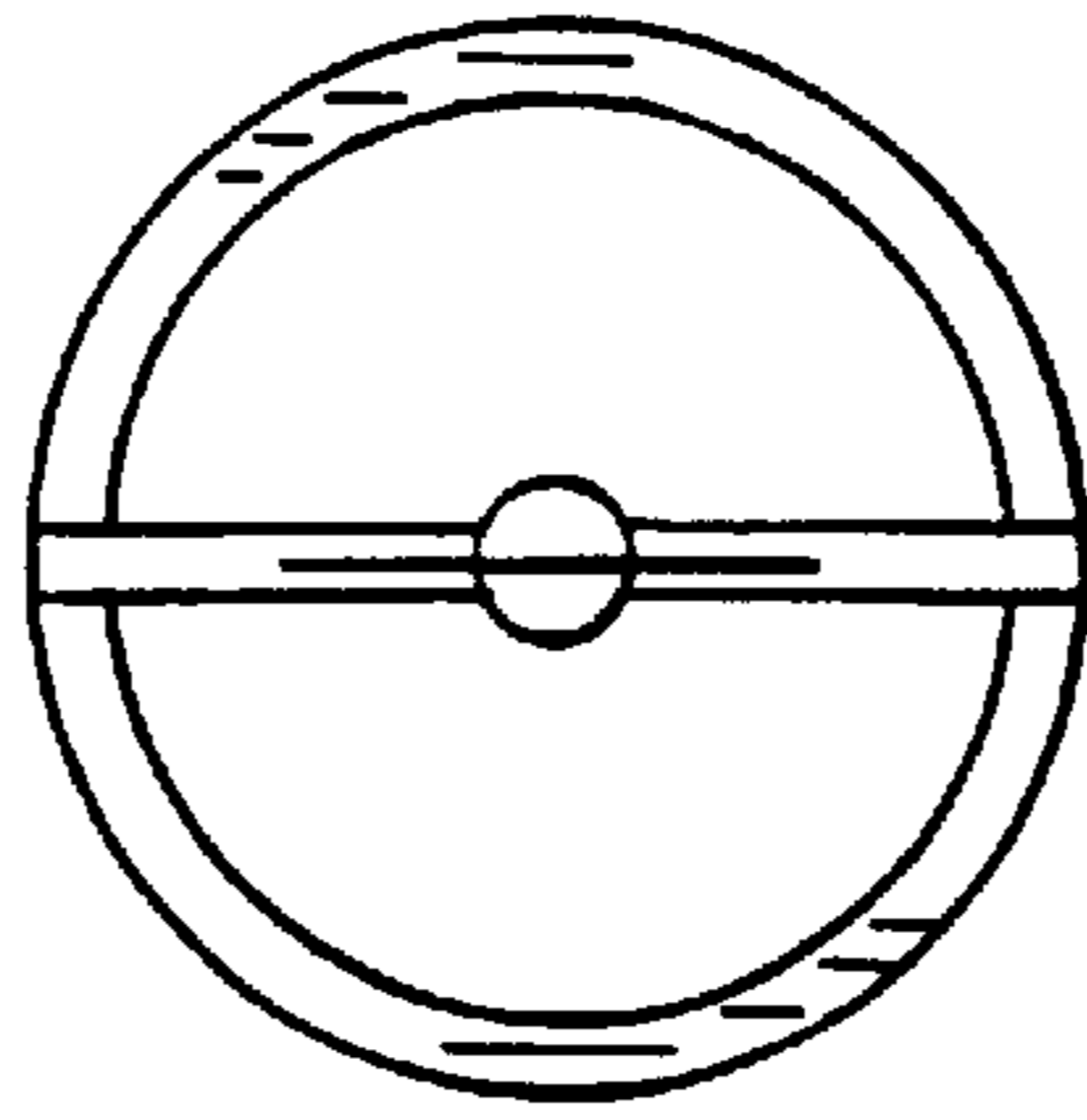

FIG. 1

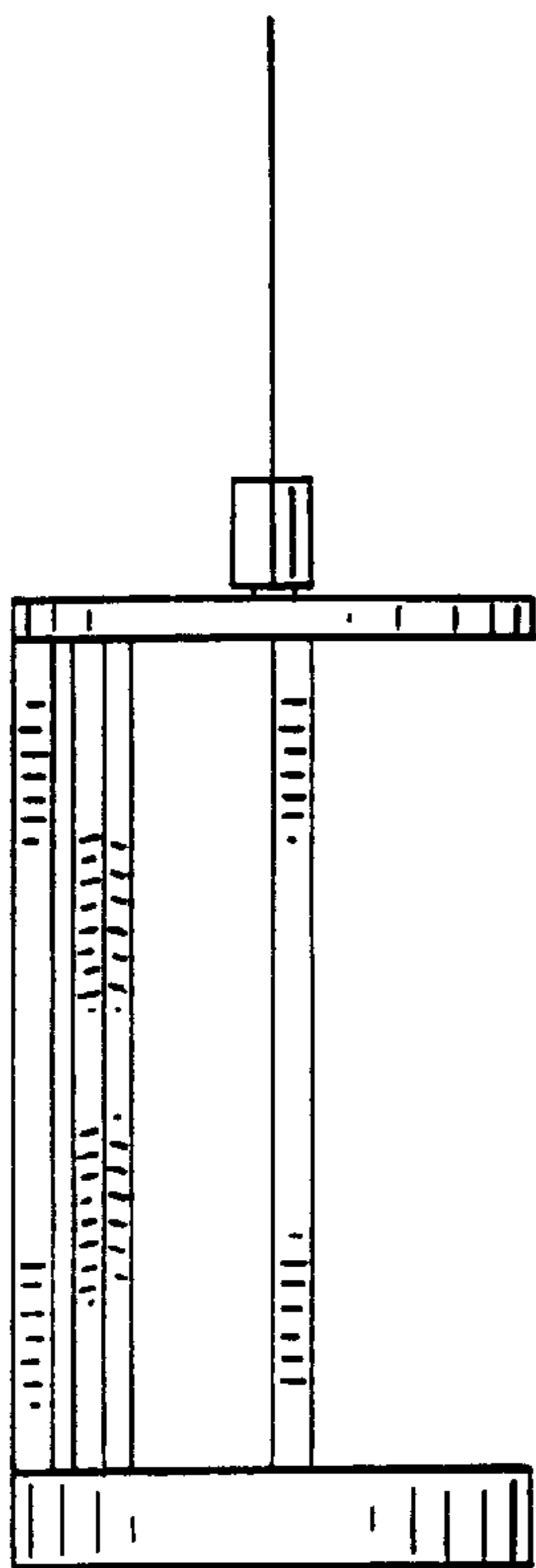

FIG. 2

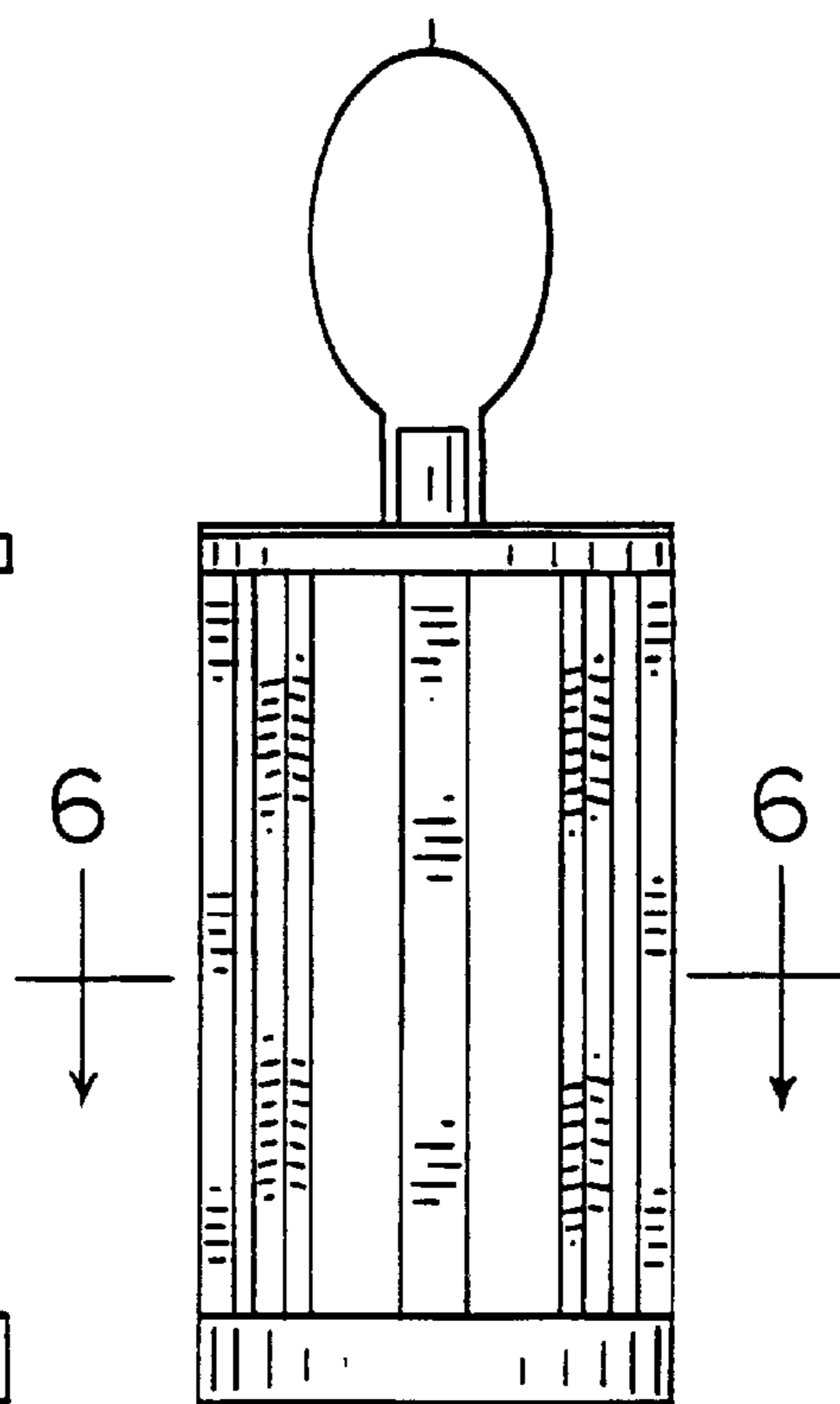

FIG. 3

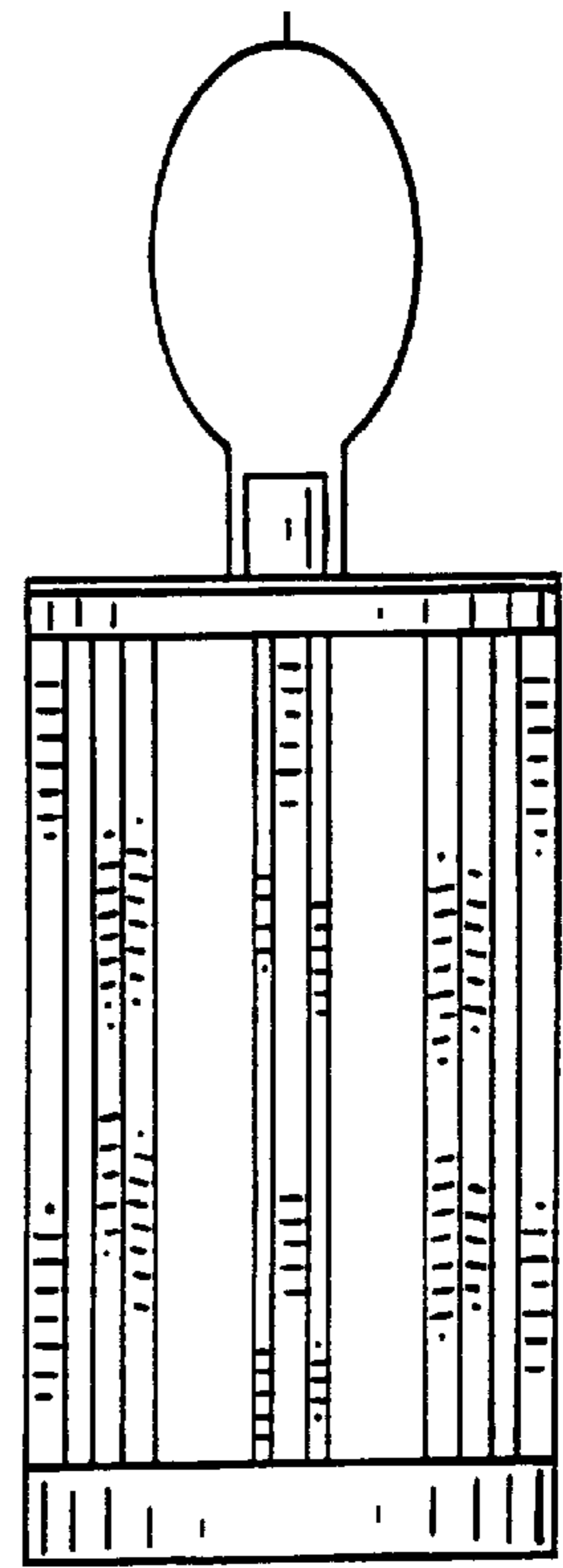

FIG. 4

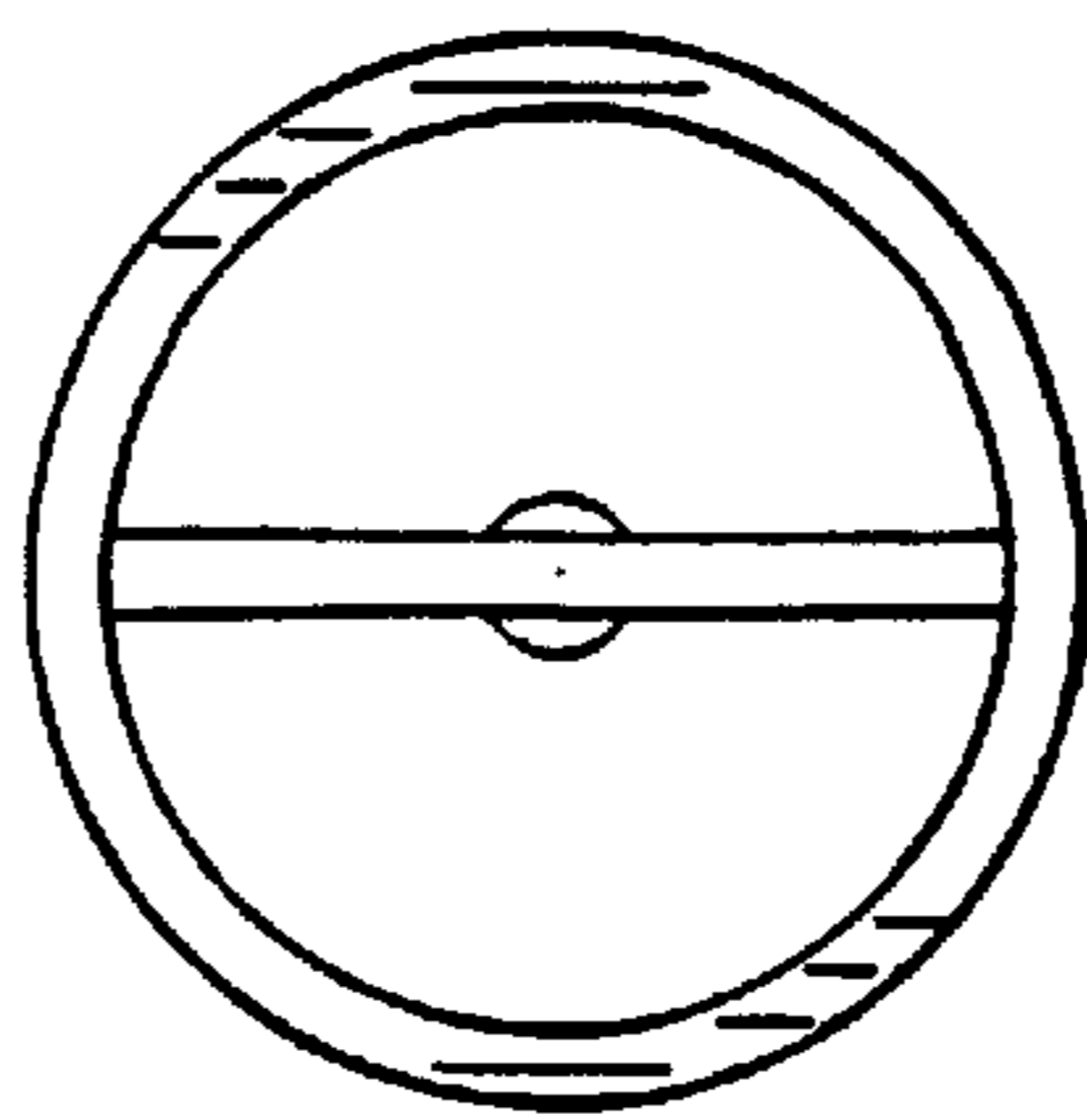

FIG. 5

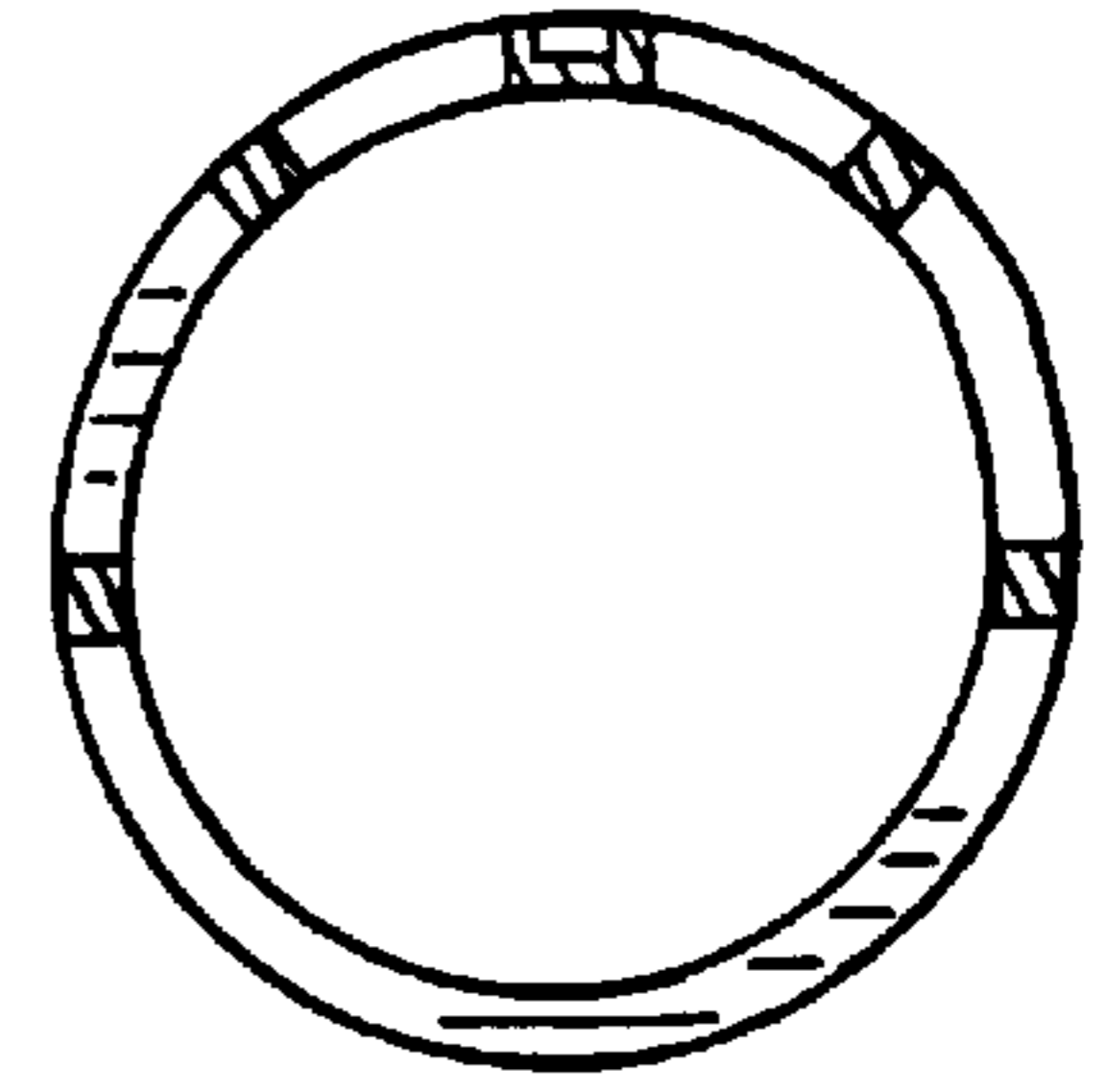

FIG. 6

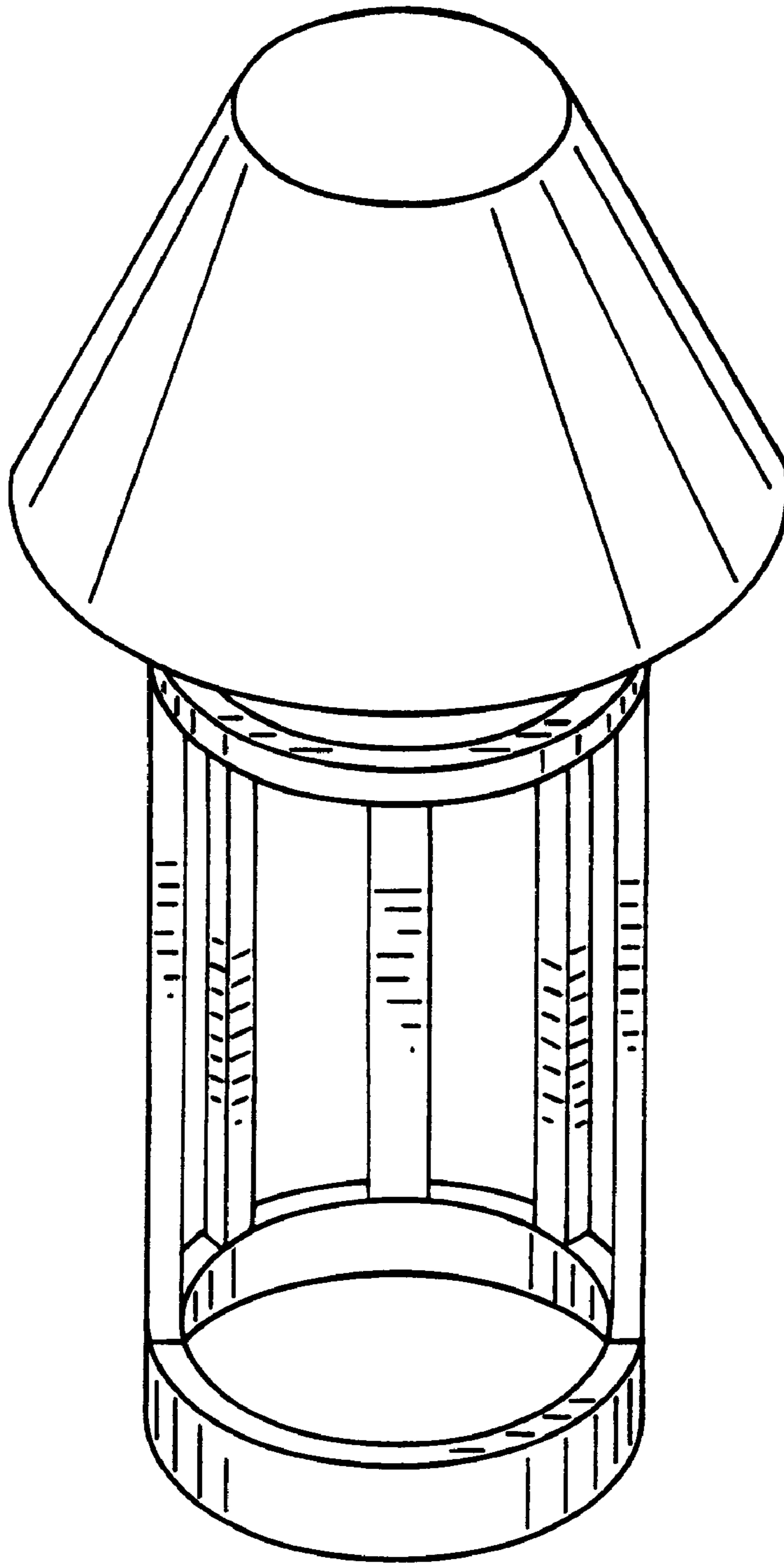

FIG. 7