



US00D436987S

(12) **United States Design Patent**
Suzuki et al.

(10) **Patent No.:** **US D436,987 S**

(45) **Date of Patent:** **** Jan. 30, 2001**

(54) **LASER PRINTER**

(75) Inventors: **Yuji Suzuki**, Kanagawa; **Yuki Nanri**,
Tokyo, both of (JP)

(73) Assignee: **Ricoh Company, Ltd.**, Tokyo (JP)

(**) Term: **14 Years**

(21) Appl. No.: **29/117,415**

(22) Filed: **Jan. 27, 2000**

(30) **Foreign Application Priority Data**

Jul. 26, 1999 (JP) 11-19921

(51) **LOC (7) Cl.** **14-02**

(52) **U.S. Cl.** **D18/55; D18/4.1**

(58) **Field of Search** D18/36-39, 50,
D18/53-55, 4.1-4.6; D14/462-470; 400/613,
613.1-613.4, 691-694, 690.1-690.4

(56) **References Cited**

U.S. PATENT DOCUMENTS

D. 304,828 * 11/1989 Watanabe D14/462

D. 373,377 * 9/1996 Fetheroff D18/50

D. 405,109 * 2/1999 Kenmochi et al. D18/54

D. 405,110 * 2/1999 Yamamoto et al. D18/54

D. 412,341 * 7/1999 Miyazawa D18/55

* cited by examiner

Primary Examiner—Cathy Anne MacCormac

(74) *Attorney, Agent, or Firm*—Dickstein Shapiro Morin &
Oshinsky LLP

(57) **CLAIM**

The ornamental design for the laser printer, as shown and
described.

DESCRIPTION

FIG. 1 is a front elevation of a laser printer showing our new
design;

FIG. 2 is a top plan view thereof;

FIG. 3 is a rear elevation thereof;

FIG. 4 is a bottom plan view thereof;

FIG. 5 is a right side elevation thereof;

FIG. 6 is a left side elevation thereof; and,

FIG. 7 is a top, front, and left side perspective view thereof.

1 Claim, 4 Drawing Sheets

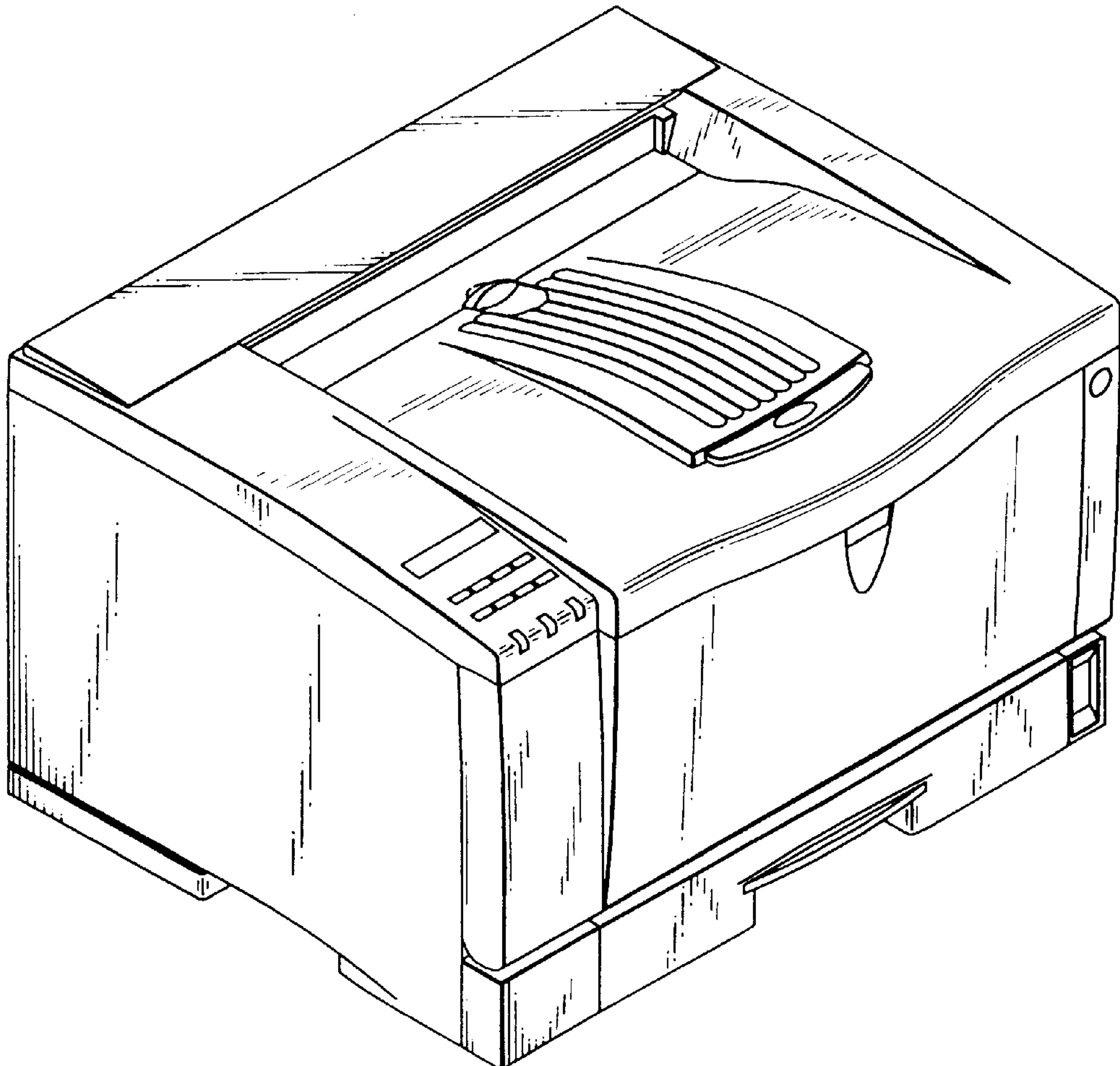

FIG. 1

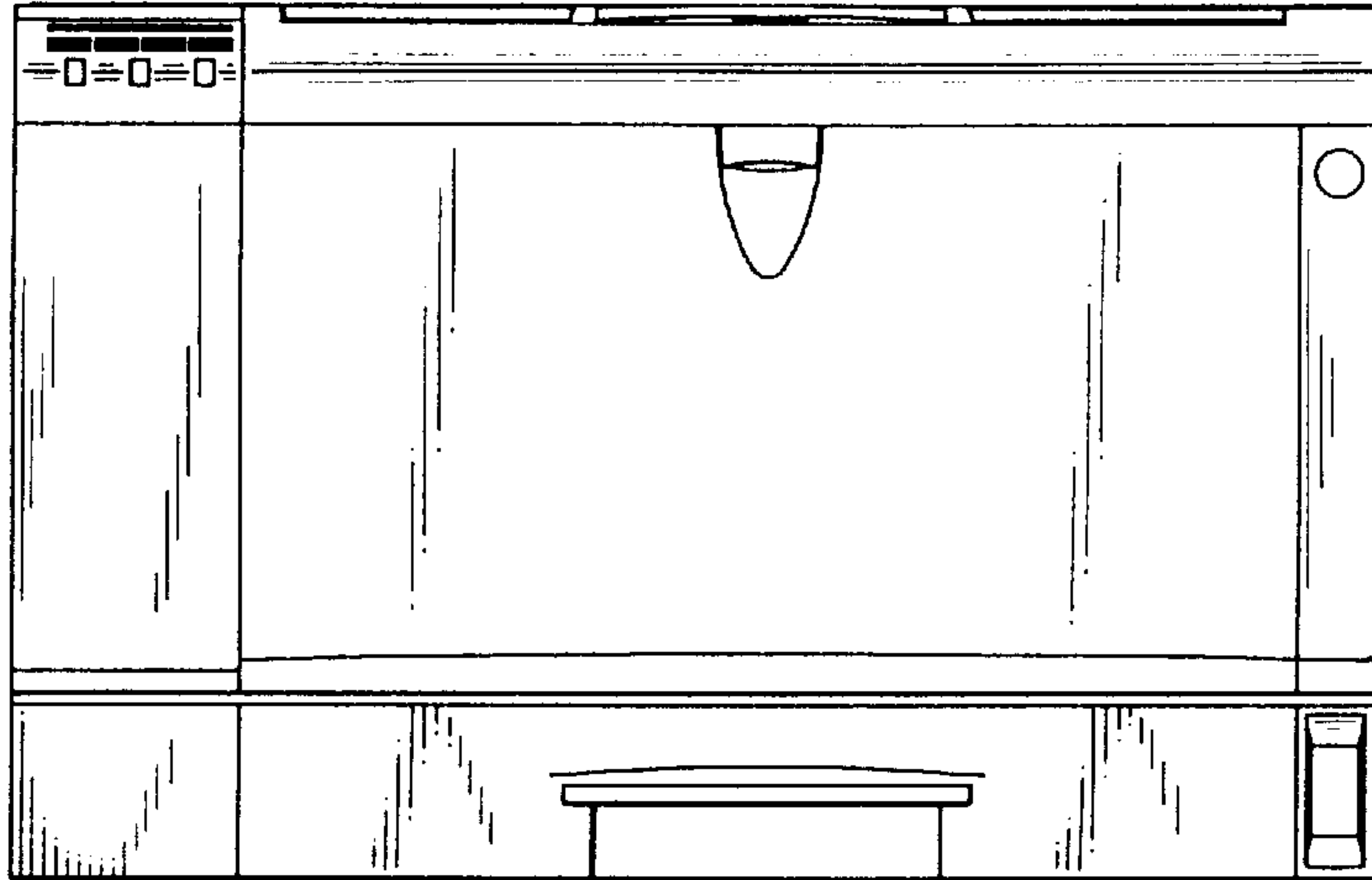

FIG. 2

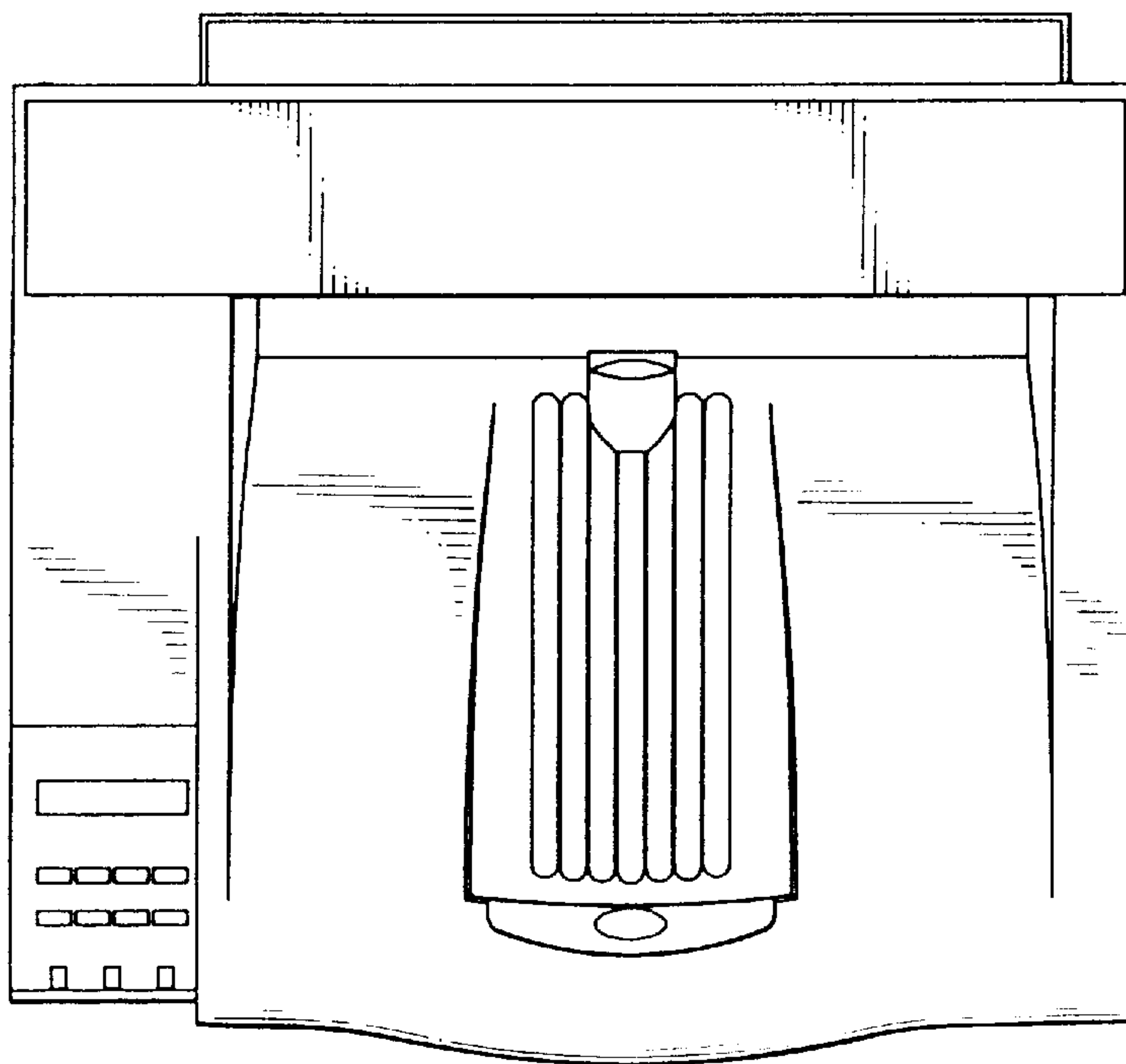

FIG. 3

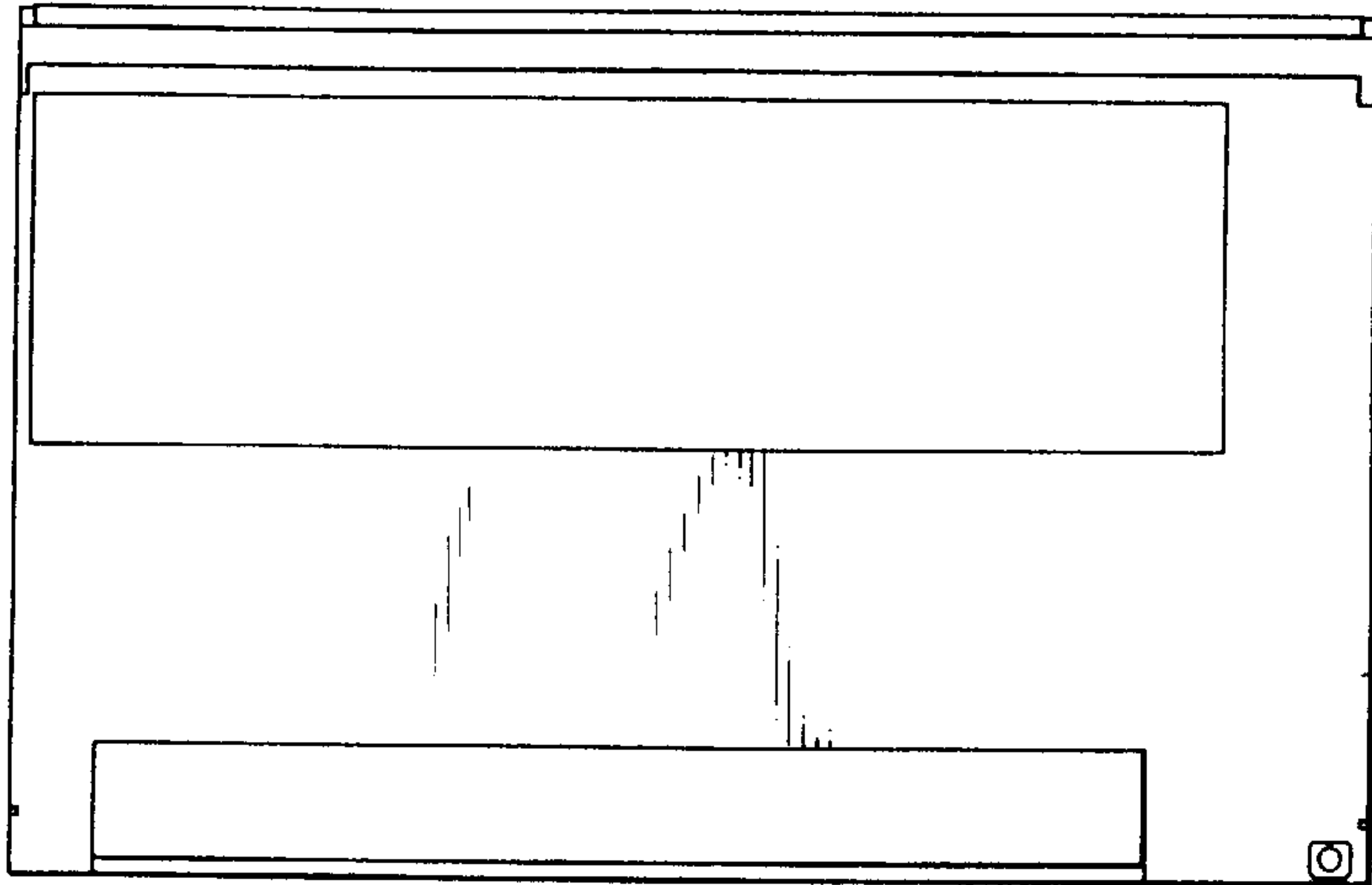

FIG. 4

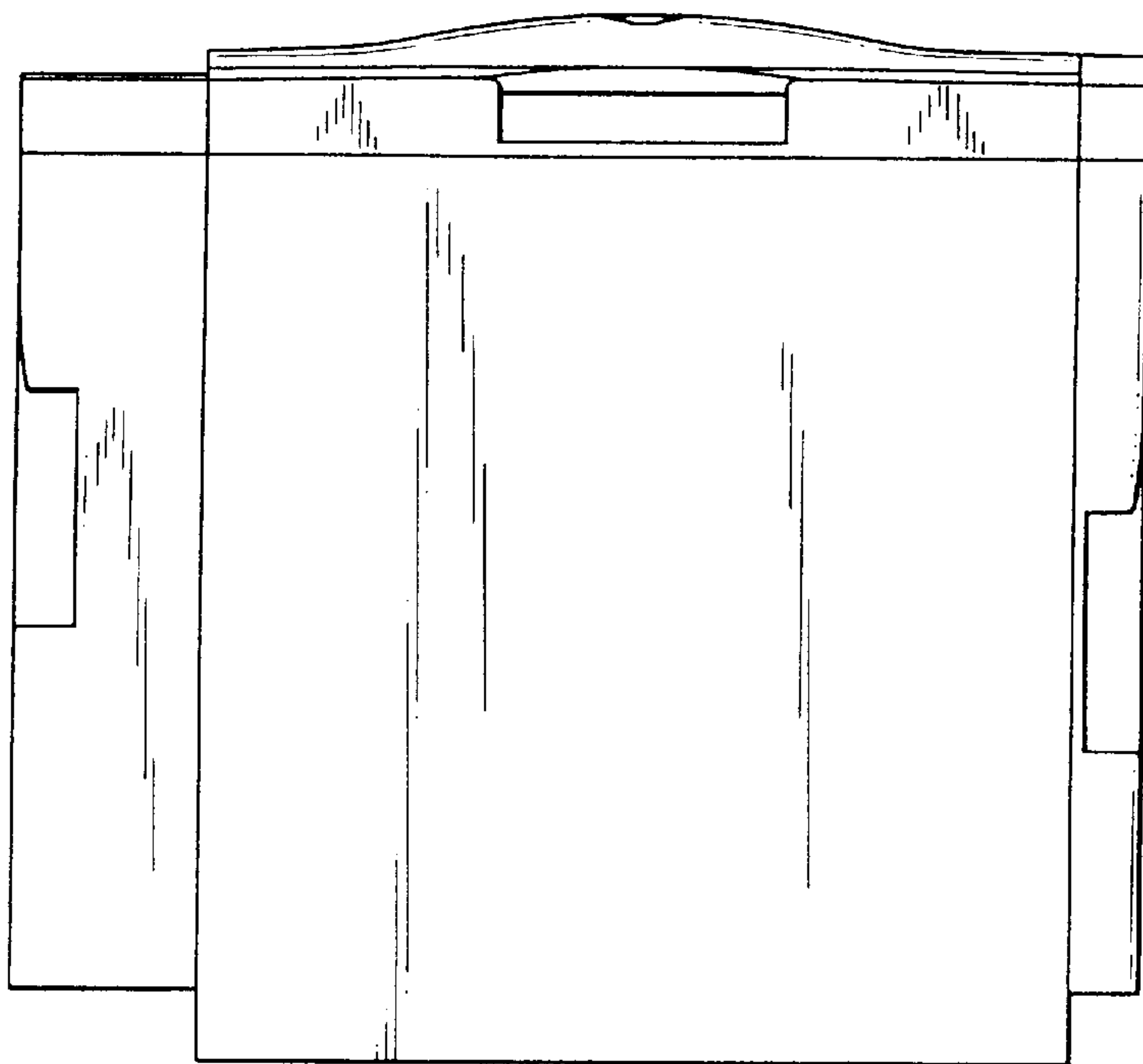

FIG. 5

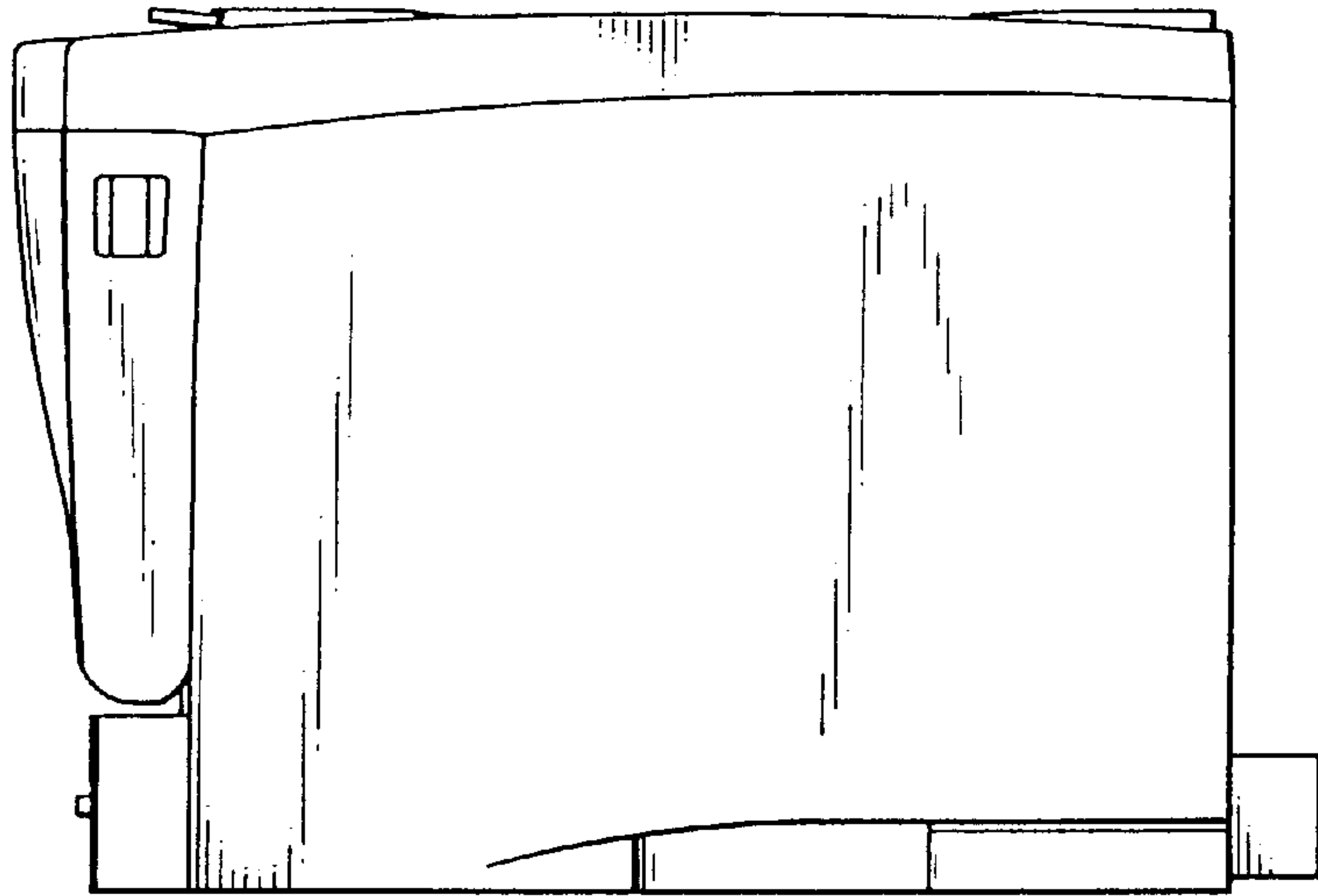

FIG. 6

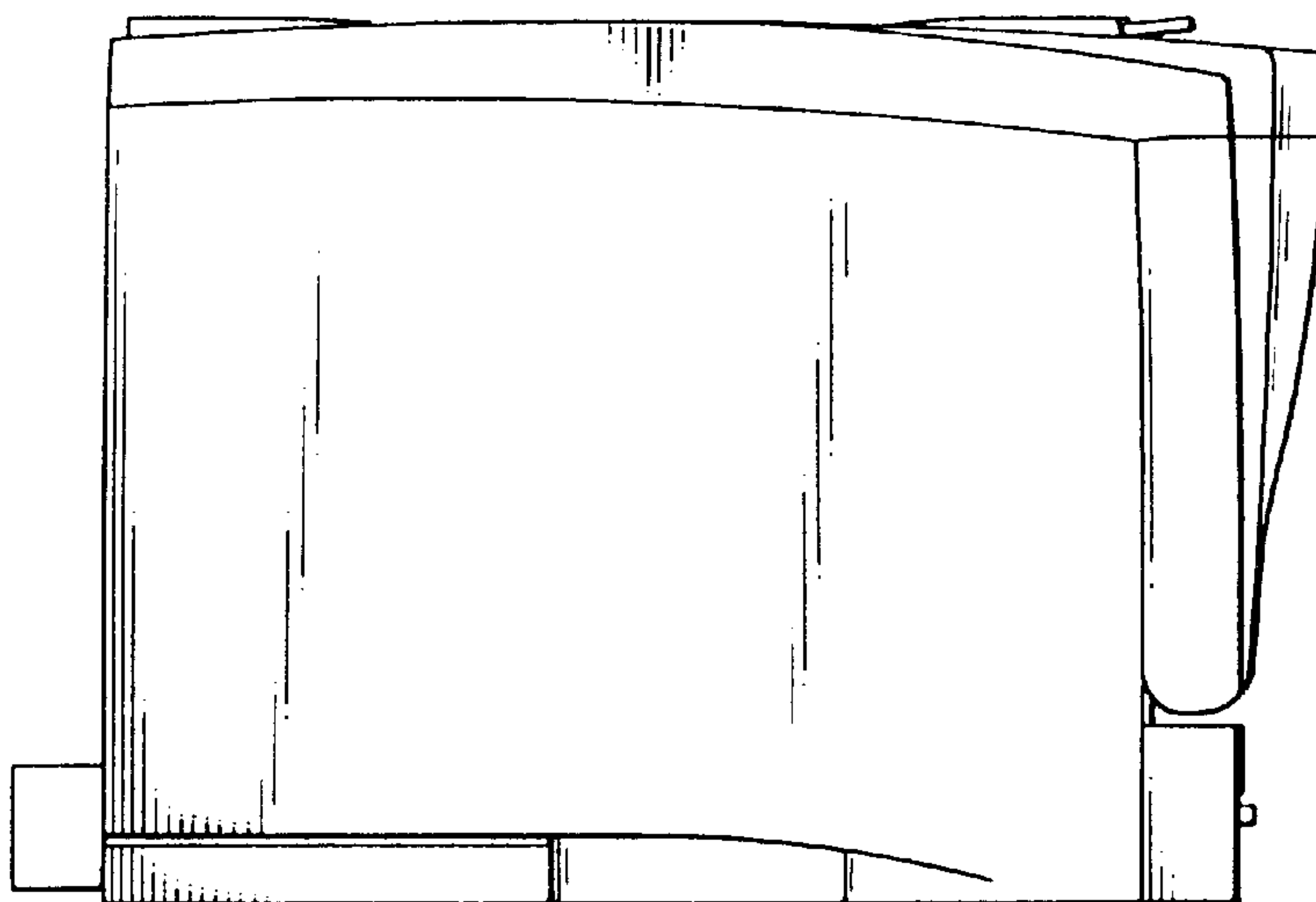

FIG. 7

