



US00D436985S

(12) **United States Design Patent**  
**Chan**

(10) **Patent No.:** **US D436,985 S**

(45) **Date of Patent:** **\*\* Jan. 30, 2001**

(54) **CALCULATOR**

D. 426,849 \* 6/2000 Lee ..... D18/7  
4,165,554 \* 8/1979 Faget ..... 16/426

(75) Inventor: **Sik-Leung Chan, NT (CN)**

\* cited by examiner

(73) Assignee: **C. C. & L Company Limited, Hong Kong (CN)**

*Primary Examiner*—Caron D. Veynar

(74) *Attorney, Agent, or Firm*—Alix, Yale & Ristas, LLP

(\*\*) Term: **14 Years**

(57) **CLAIM**

(21) Appl. No.: **29/120,995**

The ornamental design for a calculator, as shown and described.

(22) Filed: **Mar. 30, 2000**

**DESCRIPTION**

(51) **LOC (7) Cl.** ..... **18-01**

(52) **U.S. Cl.** ..... **D18/7**

(58) **Field of Search** ..... D18/2, 6, 7, 11,  
D18/12; 235/61 R; 364/706-710

FIG. 1 is a perspective view of a calculator showing my new design;

FIG. 2 is a front perspective view in opened position thereof;

FIG. 3 is a front elevational view thereof;

FIG. 4 is a top plan view thereof;

FIG. 5 is a left side elevational view thereof;

FIG. 6 is a right side elevational view thereof;

FIG. 7 is a rear elevational view thereof; and,

FIG. 8 is a bottom plan view thereof.

(56) **References Cited**

**U.S. PATENT DOCUMENTS**

- D. 235,209 \* 5/1975 Baughman ..... D18/7
- D. 243,535 \* 3/1977 Ikeda ..... D18/7
- D. 310,095 \* 8/1990 Noguchi ..... D18/7
- D. 419,588 \* 1/2000 Chan ..... D18/7

**1 Claim, 5 Drawing Sheets**

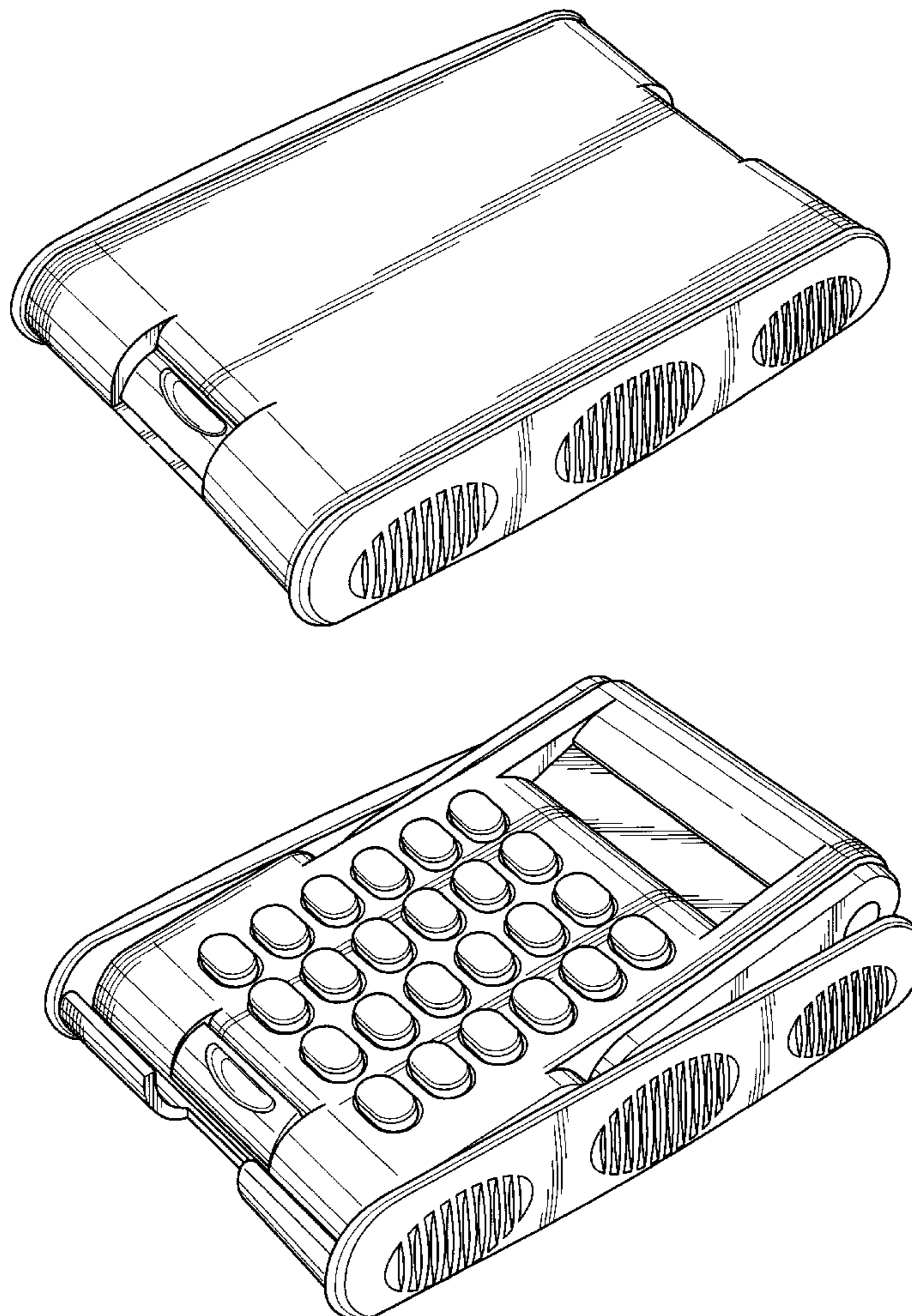

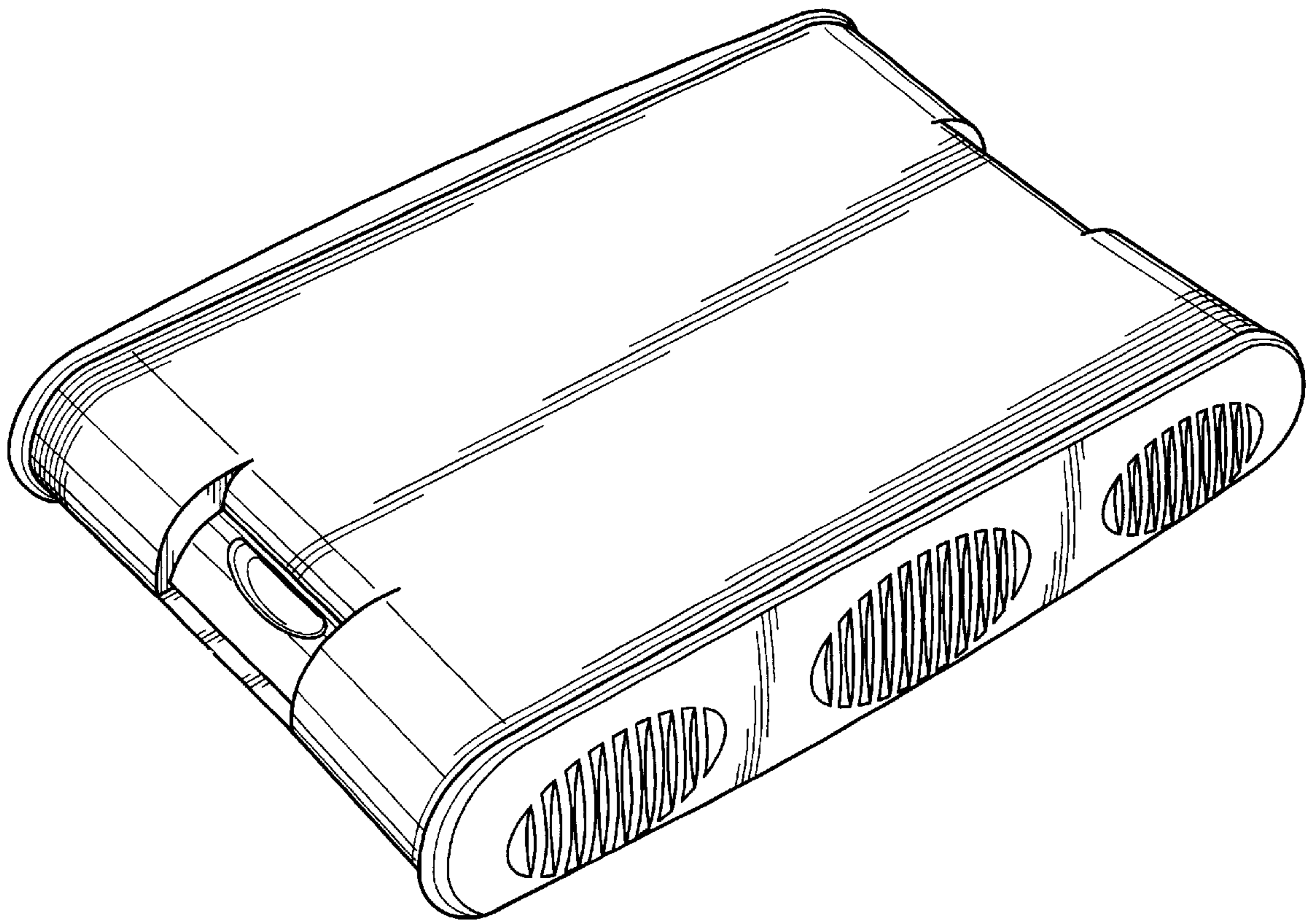

FIG. 1

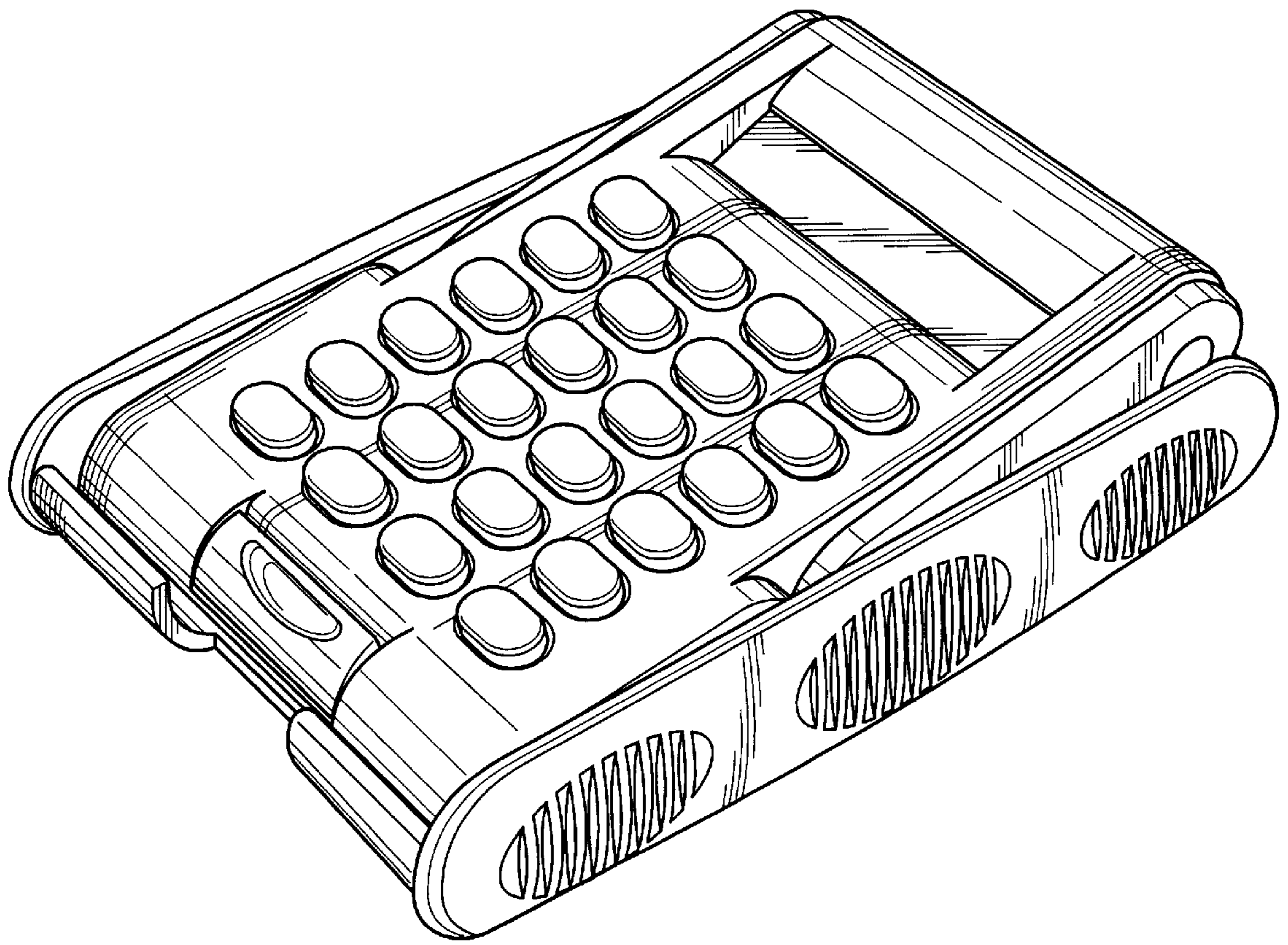

FIG. 2

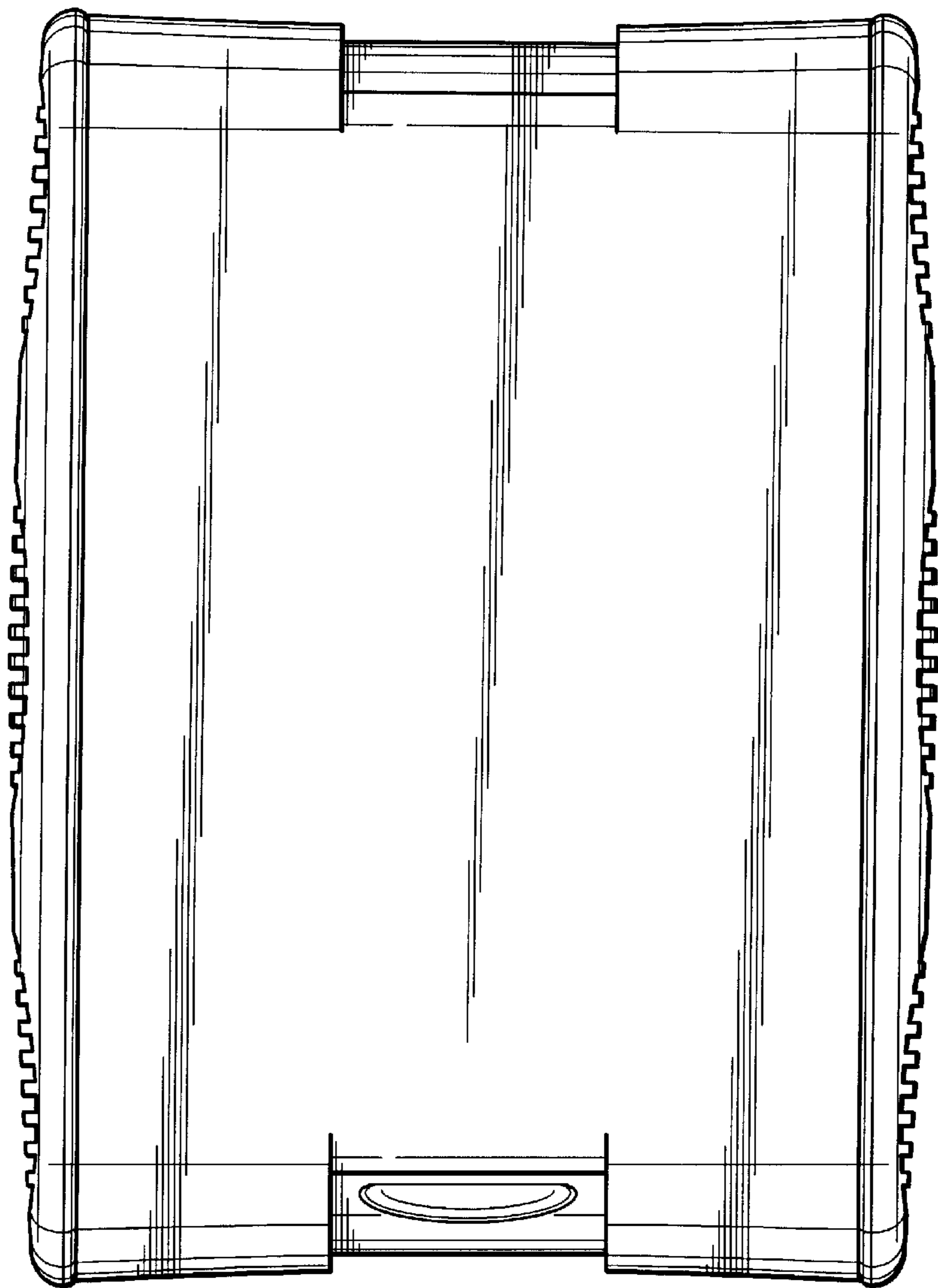

FIG. 4

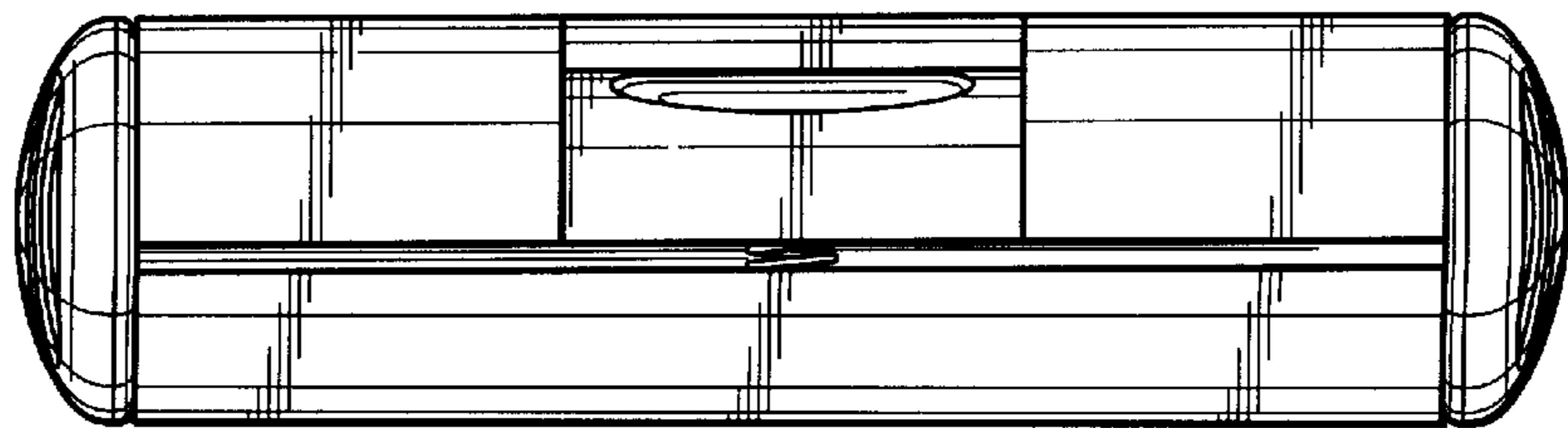

FIG. 3

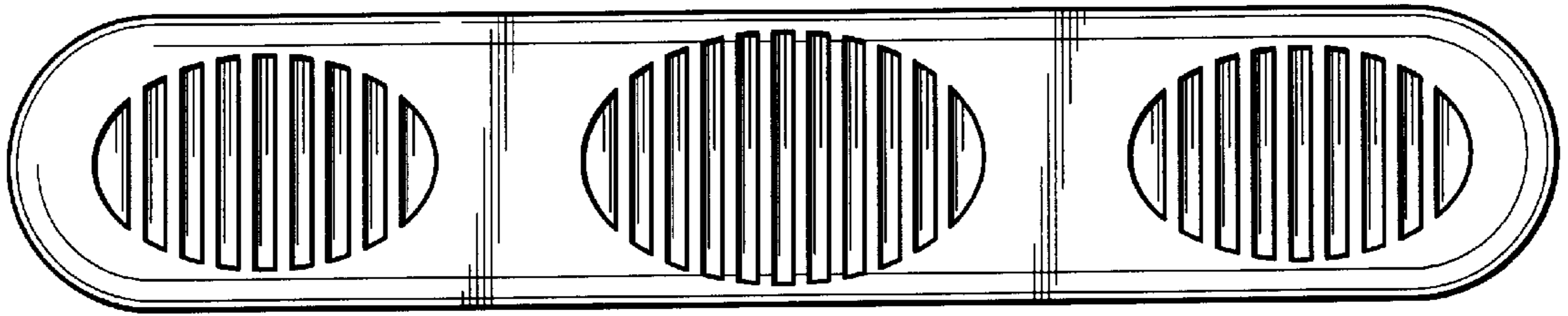

FIG. 5

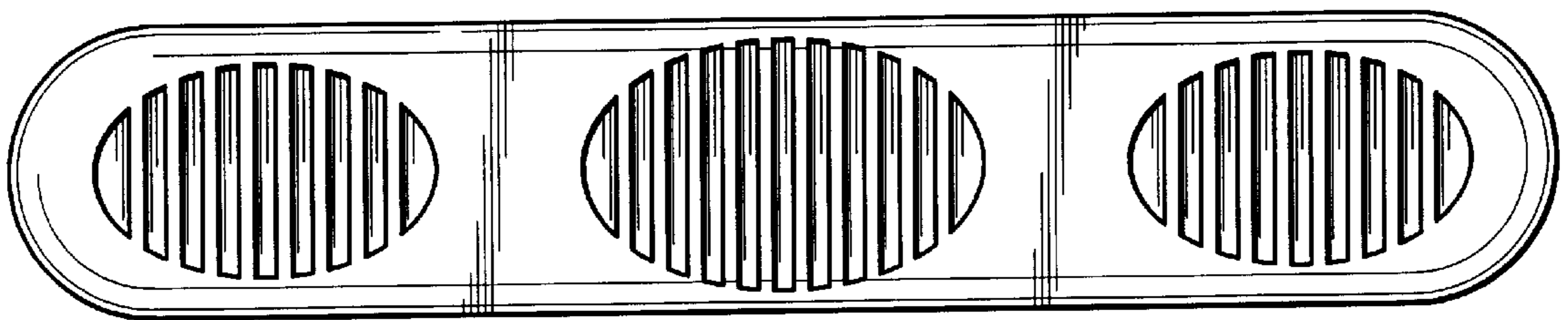

FIG. 6

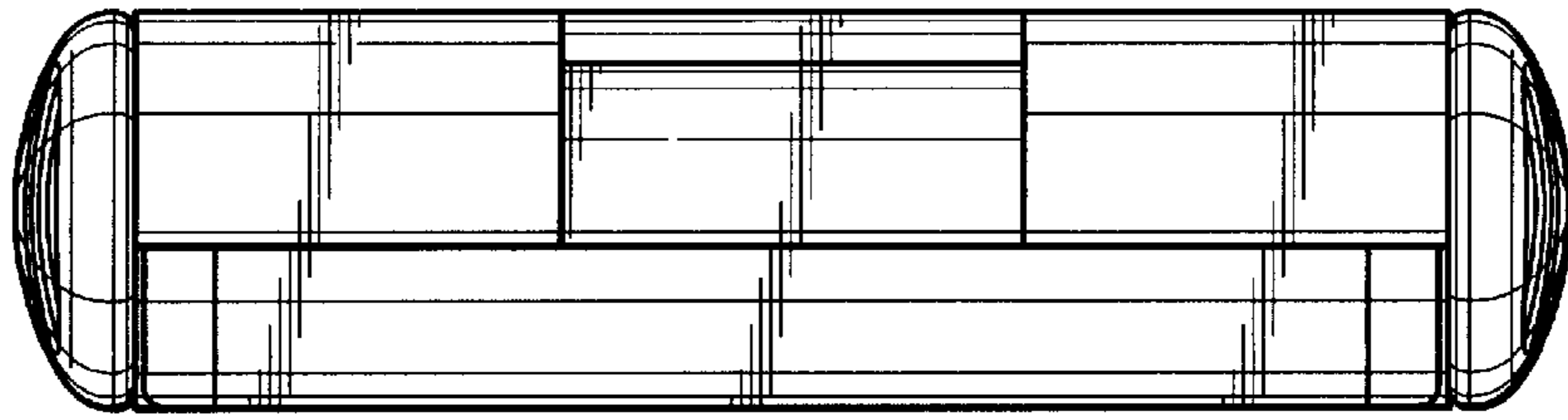

FIG. 7

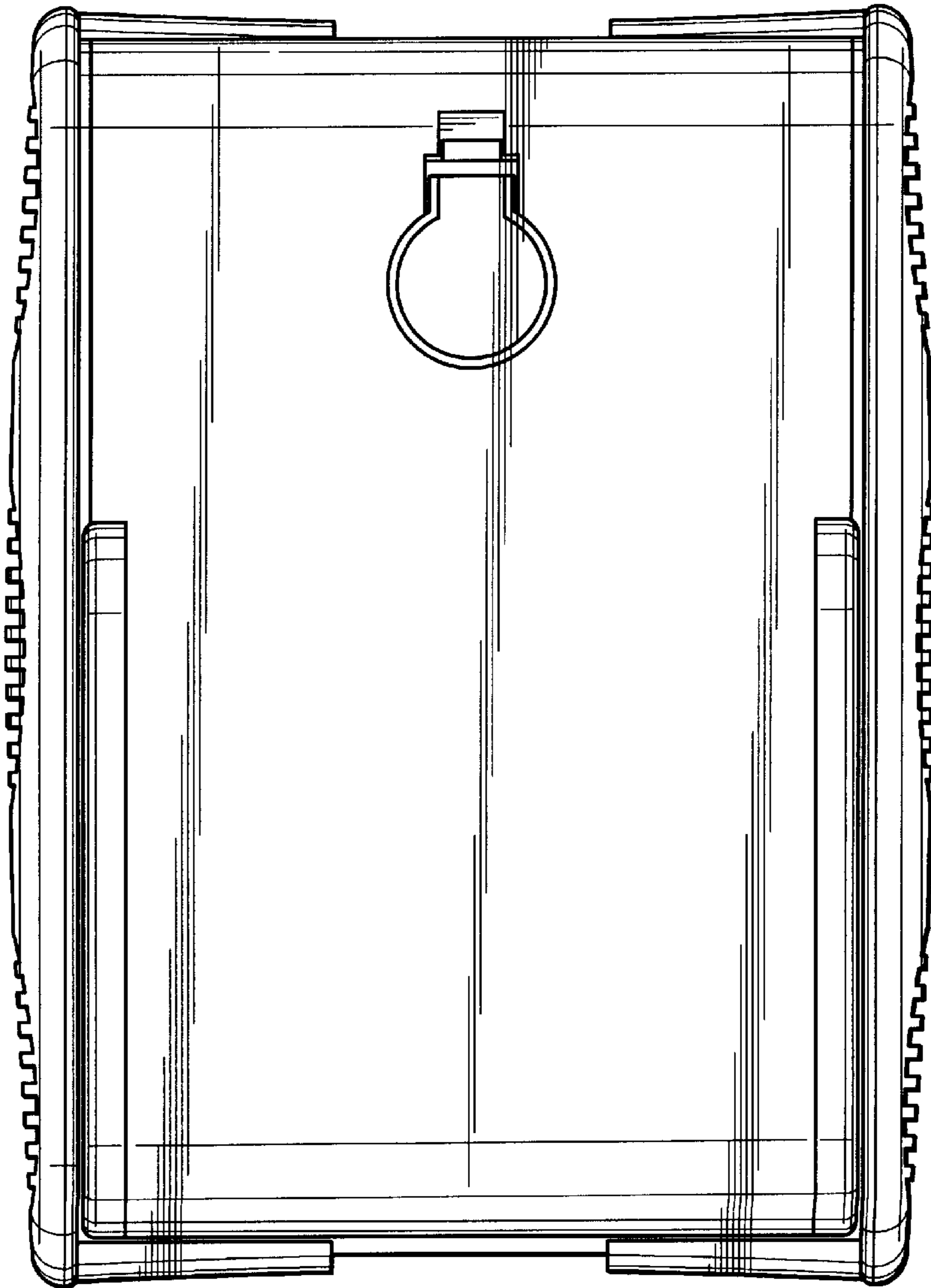

FIG. 8