



US00D436979S

(12) **United States Design Patent**  
**Yokoyama et al.**

(10) **Patent No.:** **US D436,979 S**

(45) **Date of Patent:** **\*\* Jan. 30, 2001**

(54) **LIQUID CRYSTAL VIDEO PROJECTOR**

(75) Inventors: **Yoshimasa Yokoyama**, Kokubunji;  
**Atsutoshi Sato**, Tachikawa; **Shigehisa Hagura**, Akishima; **Shinji Matsumoto**;  
**Munenori Ikeda**, both of Yokohama;  
**Mikiharu Kuwata**, Fujisawa, all of  
(JP)

(73) Assignee: **Hitachi, Ltd.**, Tokyo (JP)

(\*\*) Term: **14 Years**

(21) Appl. No.: **29/114,915**

(22) Filed: **Dec. 6, 1999**

(51) **LOC (7) Cl.** ..... **16-02**

(52) **U.S. Cl.** ..... **D16/231; D16/225**

(58) **Field of Search** ..... D16/200-205,  
D16/221, 225, 230, 231, 234; 349/5, 7,  
8, 9, 58; 353/115, 119, 122

(56) **References Cited**

**U.S. PATENT DOCUMENTS**

- D. 371,148 \* 6/1996 Kobayashi ..... D16/221
- D. 392,302 \* 3/1998 Oota et al. .... D16/221

- D. 410,020 \* 5/1999 Adachi ..... D16/231
- D. 419,581 \* 1/2000 Ishibashi et al. .... D16/231
- D. 422,292 \* 4/2000 Takizawa ..... D16/231
- D. 424,090 \* 5/2000 Ko et al. .... D16/231
- 5,868,485 \* 2/1999 Fujimori et al. .... 353/119

\* cited by examiner

*Primary Examiner*—Adir Aronovich

(74) *Attorney, Agent, or Firm*—Antonelli, Terry, Stout & Kraus, LLP

(57) **CLAIM**

The ornamental design for a liquid crystal video projector, as shown.

**DESCRIPTION**

FIG. 1 is a front, top and left side perspective view of a liquid crystal video projector showing our new design; FIG. 2 is a front elevational view thereof; FIG. 3 is a rear side elevational view thereof; FIG. 4 is a top plan view thereof; FIG. 5 is a right side elevational view thereof; FIG. 6 is a left side elevational view thereof; and, FIG. 7 is a bottom plan view thereof.

**1 Claim, 5 Drawing Sheets**

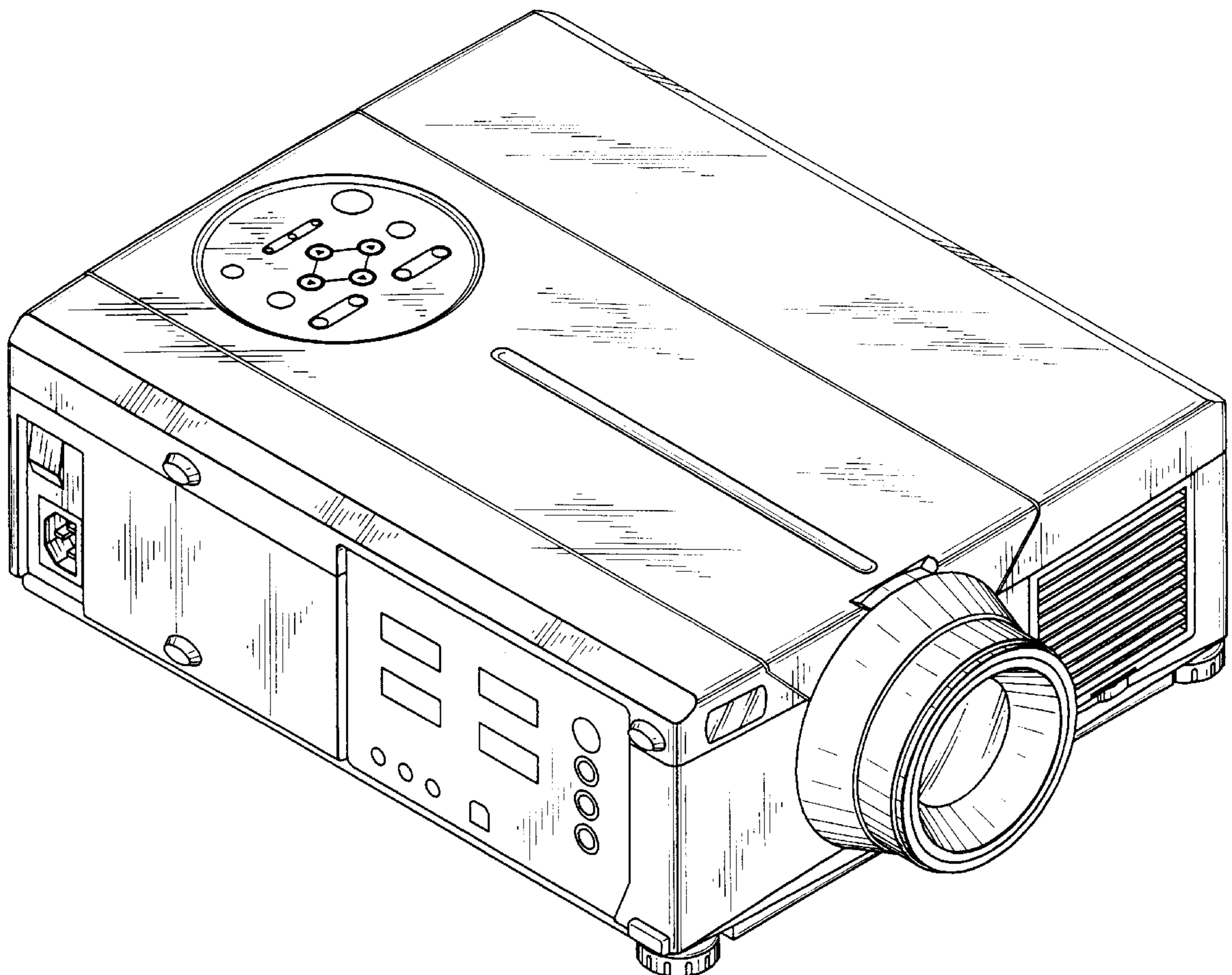

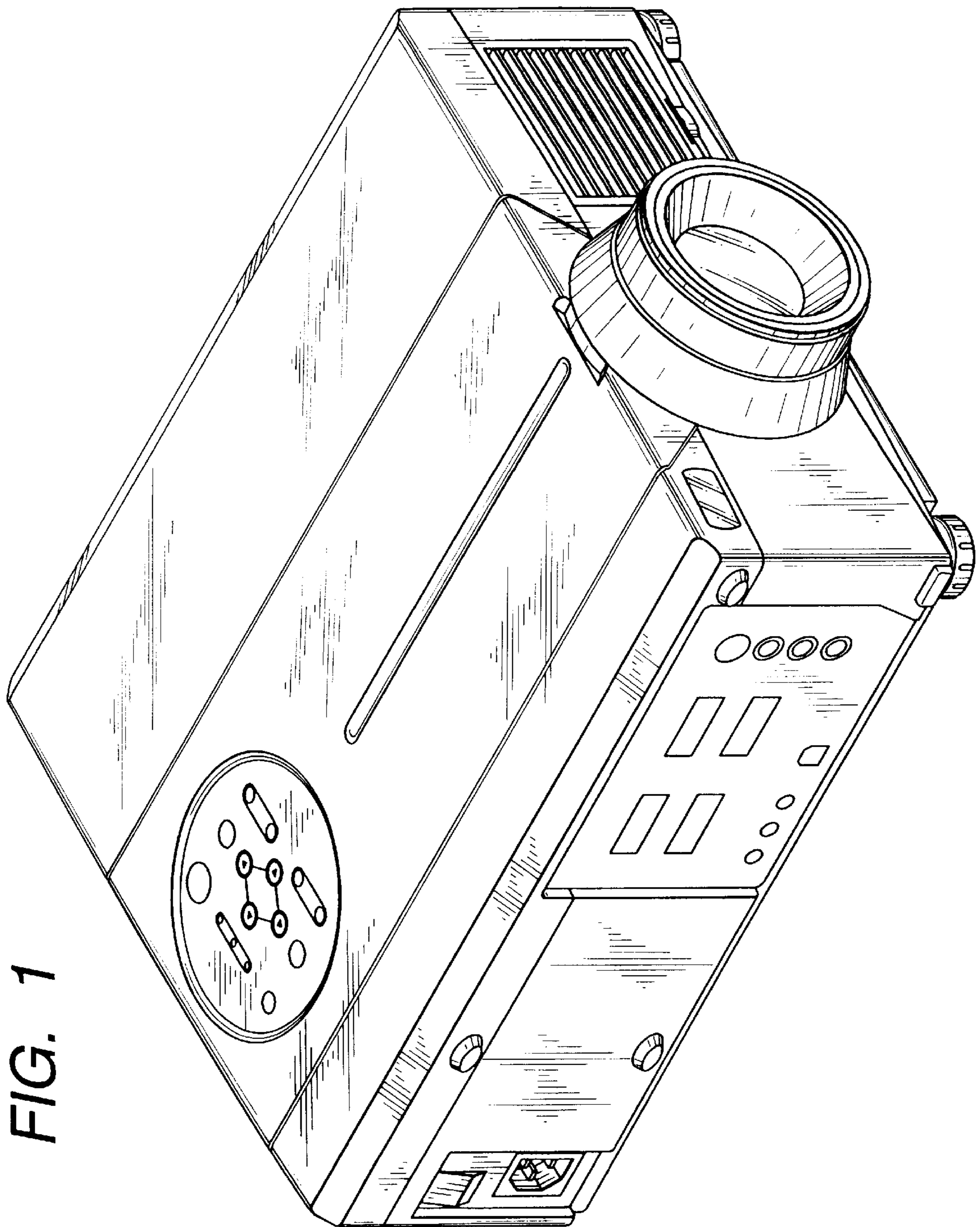
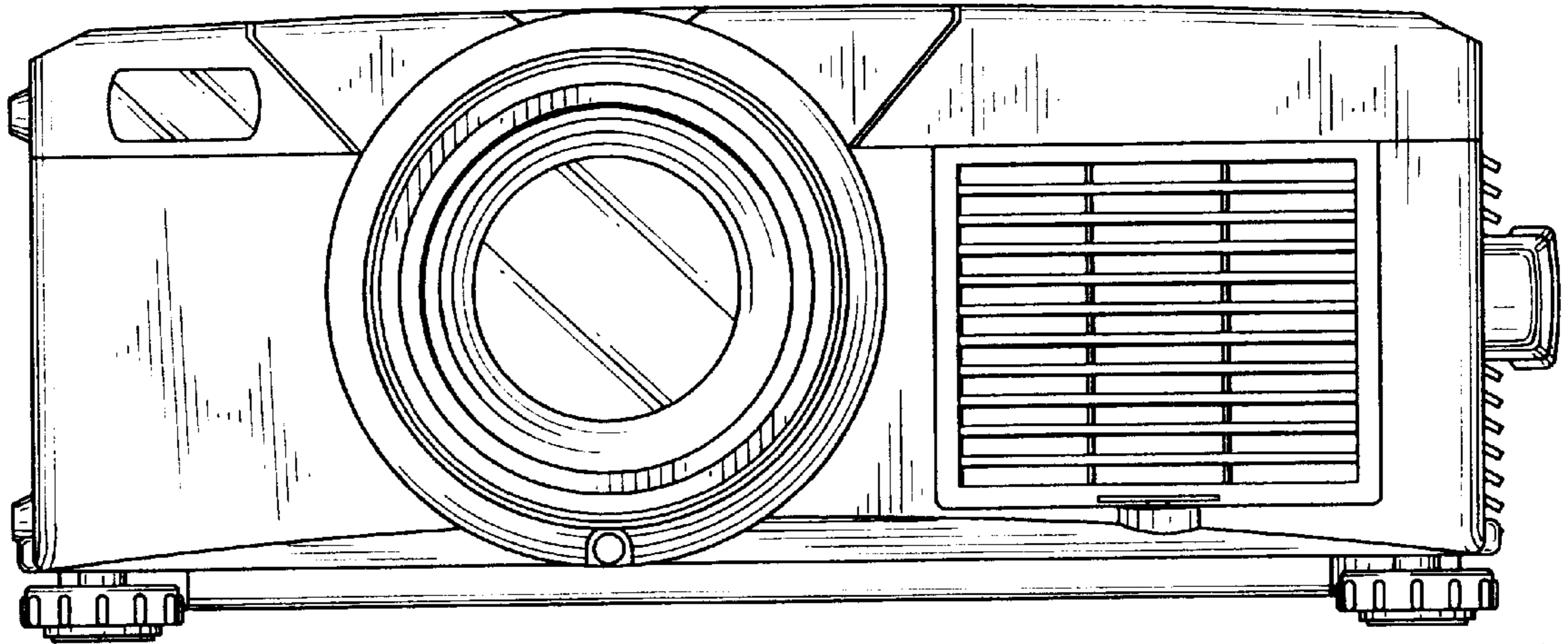
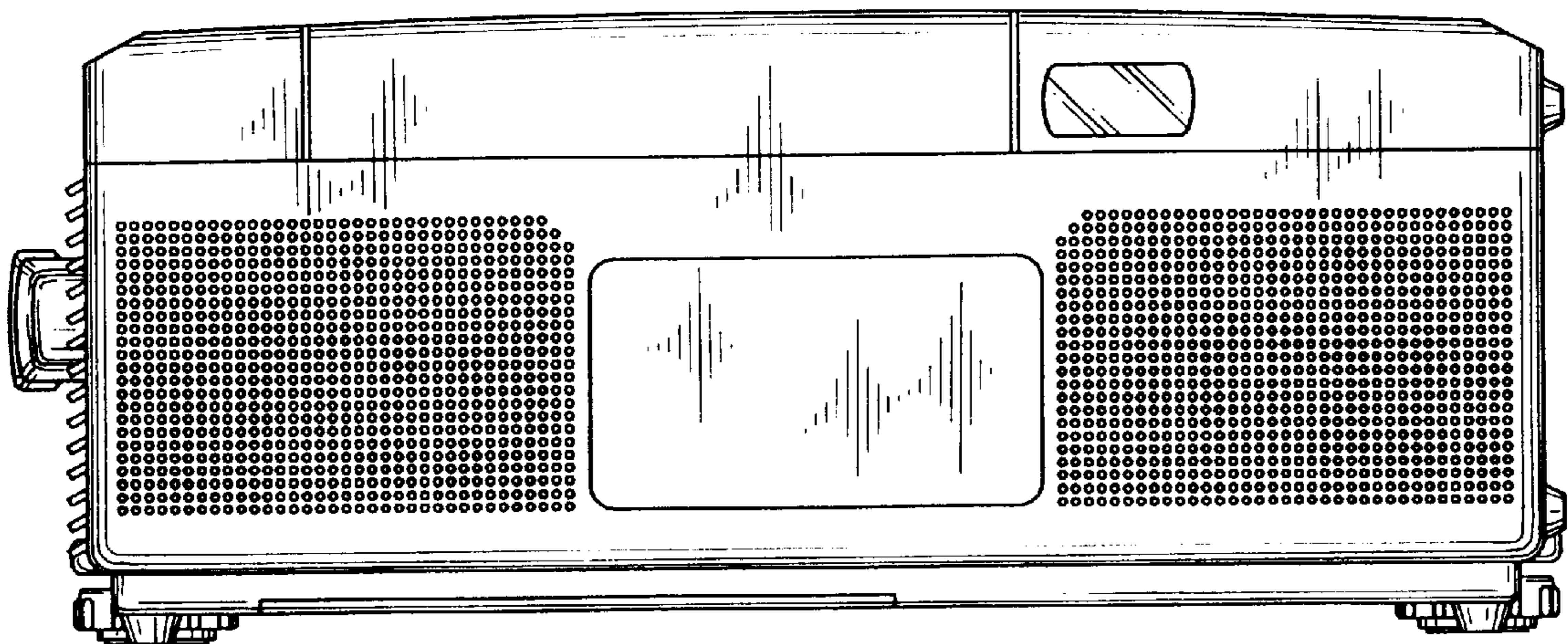

FIG. 1

*FIG. 2*



*FIG. 3*



*FIG. 4*

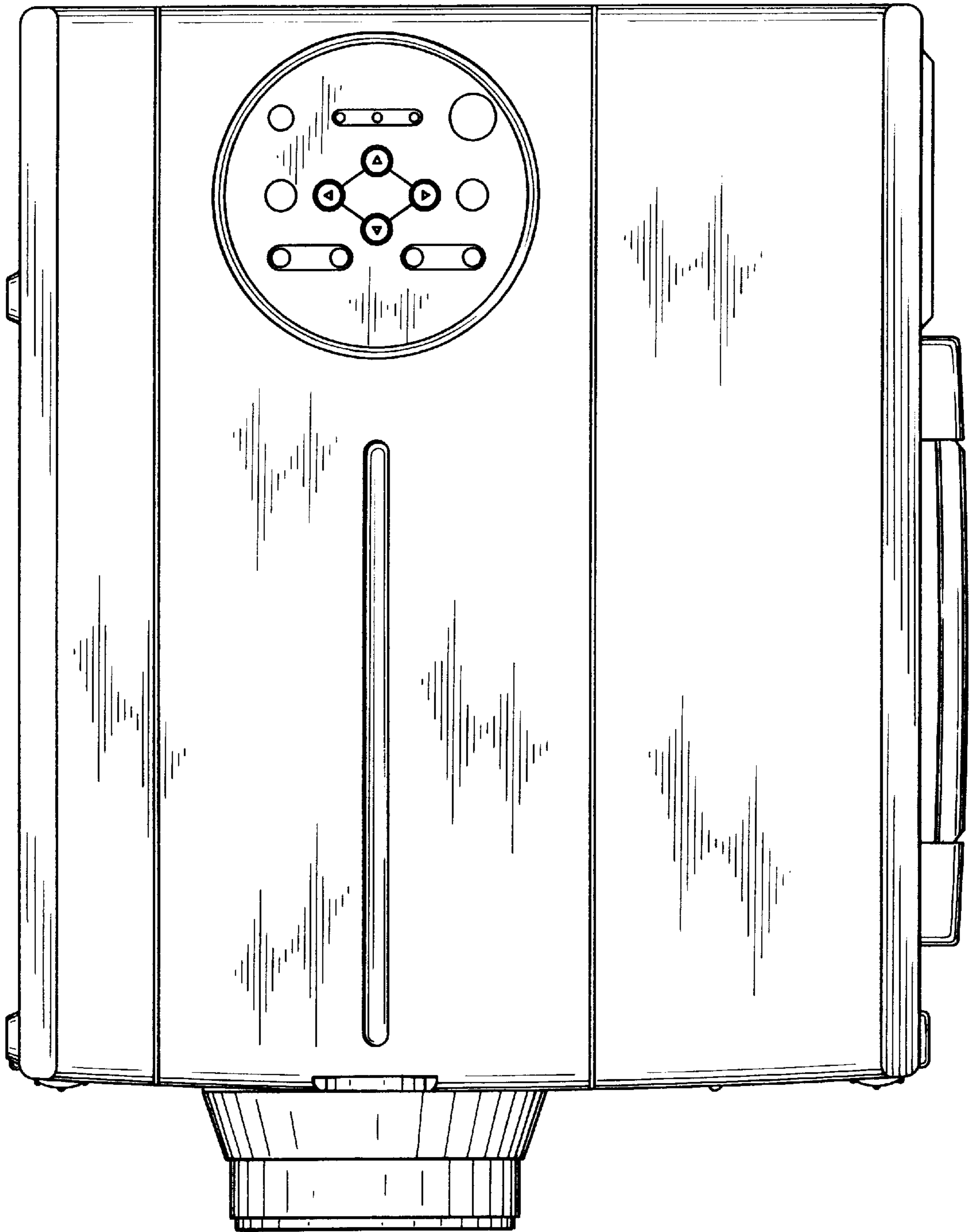

FIG. 5

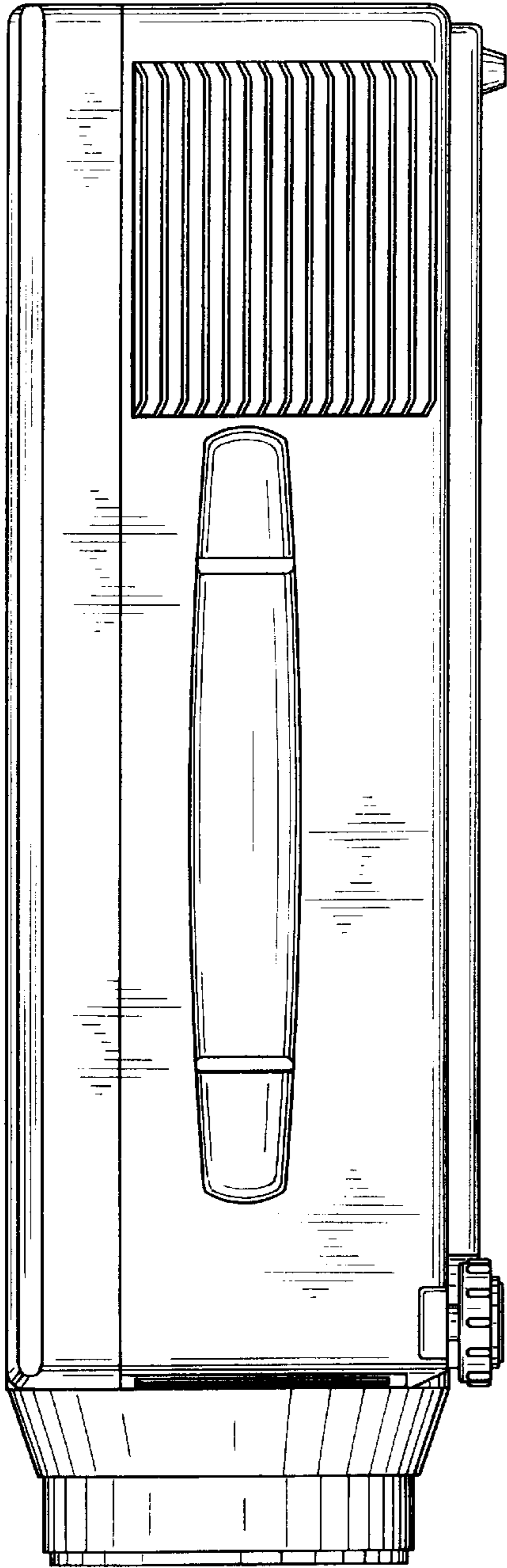
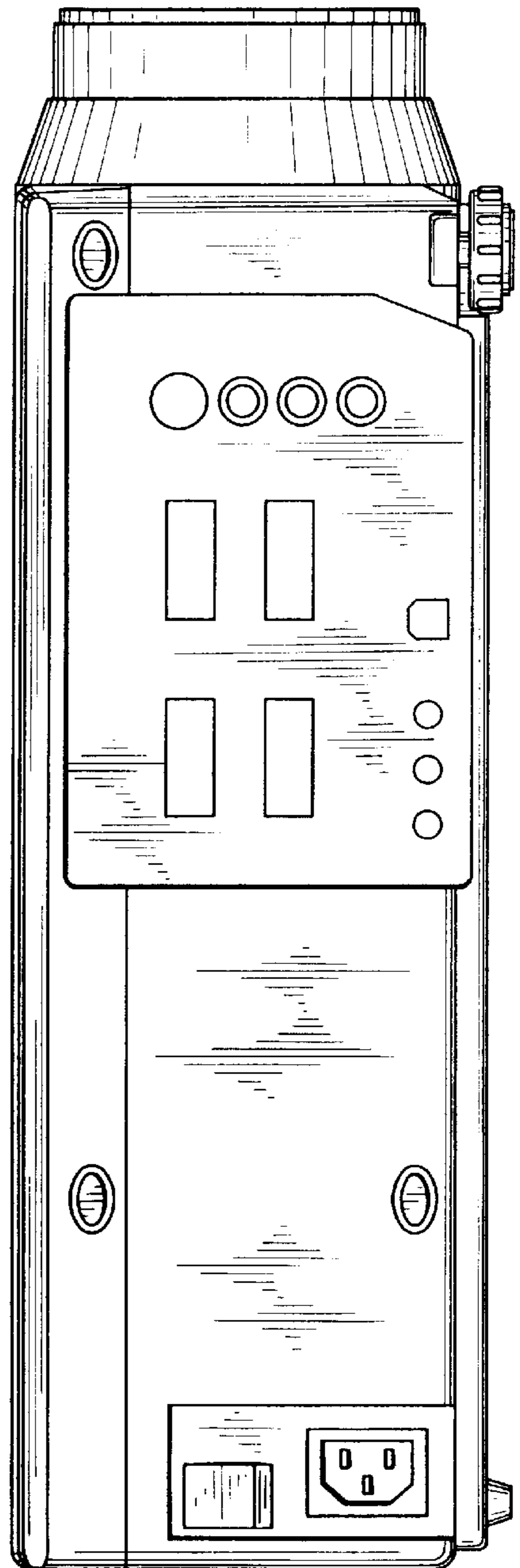

FIG. 6



*FIG. 7*

