



US00D436973S

(12) **United States Design Patent**
Kawahata

(10) **Patent No.:** **US D436,973 S**

(45) **Date of Patent:** **** Jan. 30, 2001**

(54) **MICROSCOPE**

(75) **Inventor:** **Nobuya Kawahata, Yokosuka (JP)**

(73) **Assignee:** **Nikon Corporation, Tokyo (JP)**

(**) **Term:** **14 Years**

(21) **Appl. No.:** **29/119,605**

(22) **Filed:** **Mar. 6, 2000**

(30) **Foreign Application Priority Data**

Sep. 30, 1999 (JP) 11-26473

(51) **LOC (7) Cl.** **16-06**

(52) **U.S. Cl.** **D16/131**

(58) **Field of Search** D16/130, 131;
359/368, 376, 377, 381, 388, 385, 390,
393

(56) **References Cited**

U.S. PATENT DOCUMENTS

- D. 273,592 * 4/1984 Armbruster D16/131
- D. 291,702 * 9/1987 Kahute D16/131
- D. 296,904 * 7/1988 Lukaszewski D16/131
- D. 340,251 * 10/1993 Frenklor et al. D16/131

- D. 345,746 * 4/1994 Hölbl D16/131
- D. 354,761 * 1/1995 Komatsuzaki et al. D16/131
- D. 395,664 * 6/1998 Nojima et al. D16/131
- D. 400,548 * 11/1998 Komatsuzaki D16/131
- D. 420,028 * 2/2000 Wani et al. D16/131
- 2,967,456 * 1/1961 Maier 359/376 X
- 3,064,529 * 11/1962 Straat 359/381 X
- 4,283,111 * 8/1981 Wieber et al. 359/381

* cited by examiner

Primary Examiner—Paula A. Mortimer

(74) *Attorney, Agent, or Firm*—Oliff & Berridge, PLC

(57) **CLAIM**

The ornamental design for microscope, as shown.

DESCRIPTION

FIG. 1 is a front perspective view of microscope showing my new design;
 FIG. 2 is a front view thereof;
 FIG. 3 is a rear view thereof;
 FIG. 4 is a top plan view thereof;
 FIG. 5 is a bottom plan view thereof;
 FIG. 6 is a right side view thereof; and,
 FIG. 7 is a left side view thereof.

1 Claim, 7 Drawing Sheets

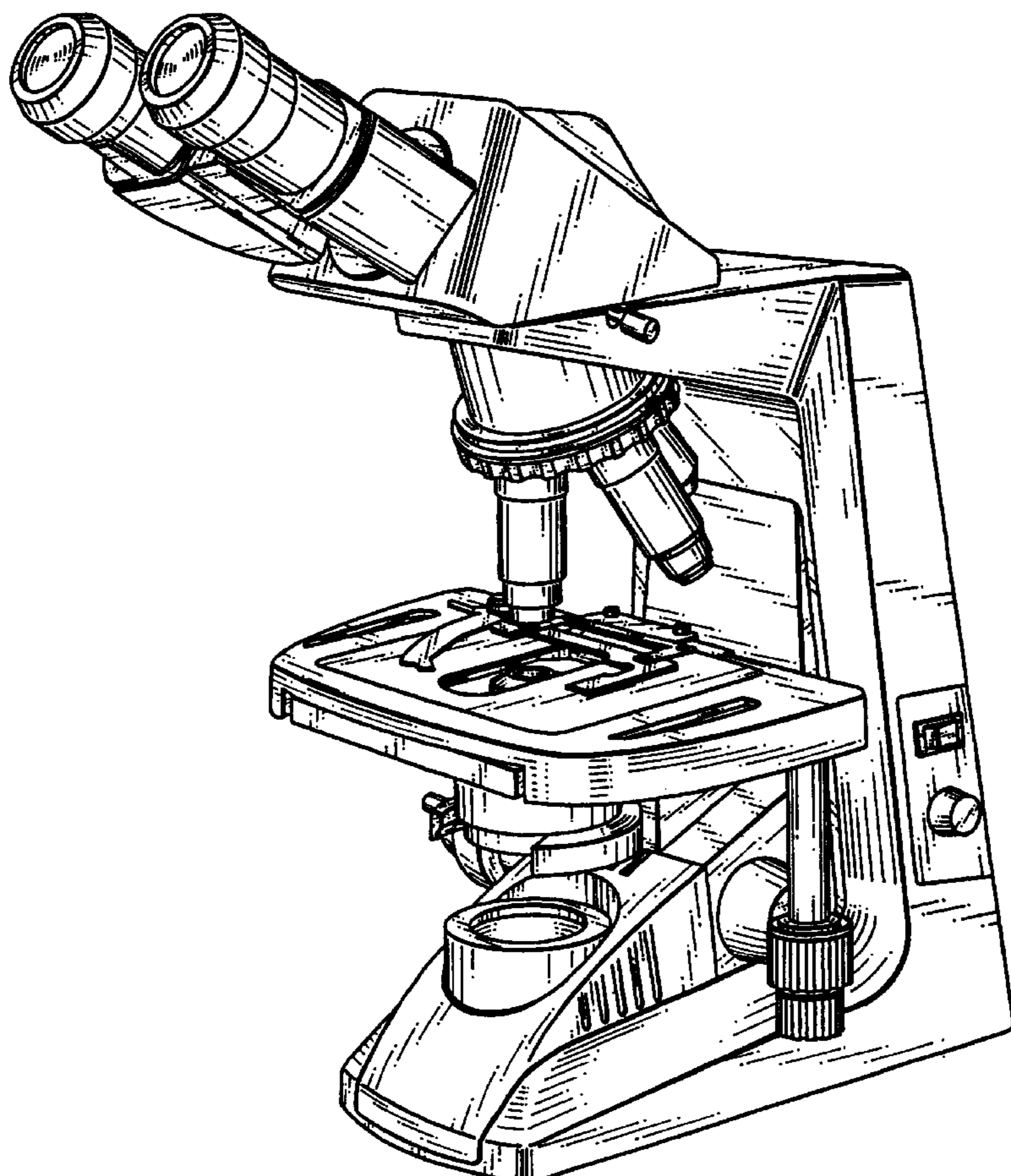

FIG. 1

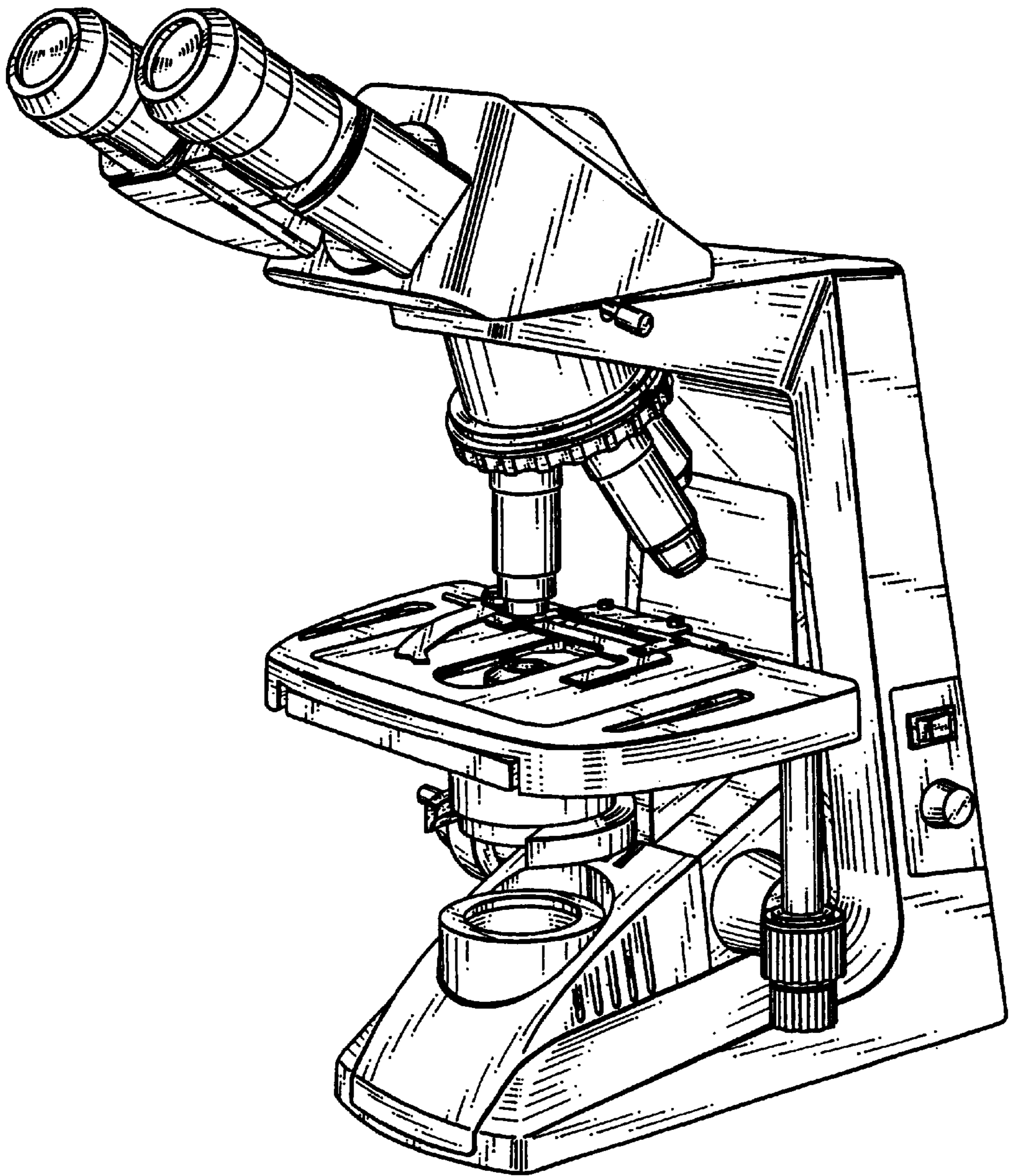

FIG. 2

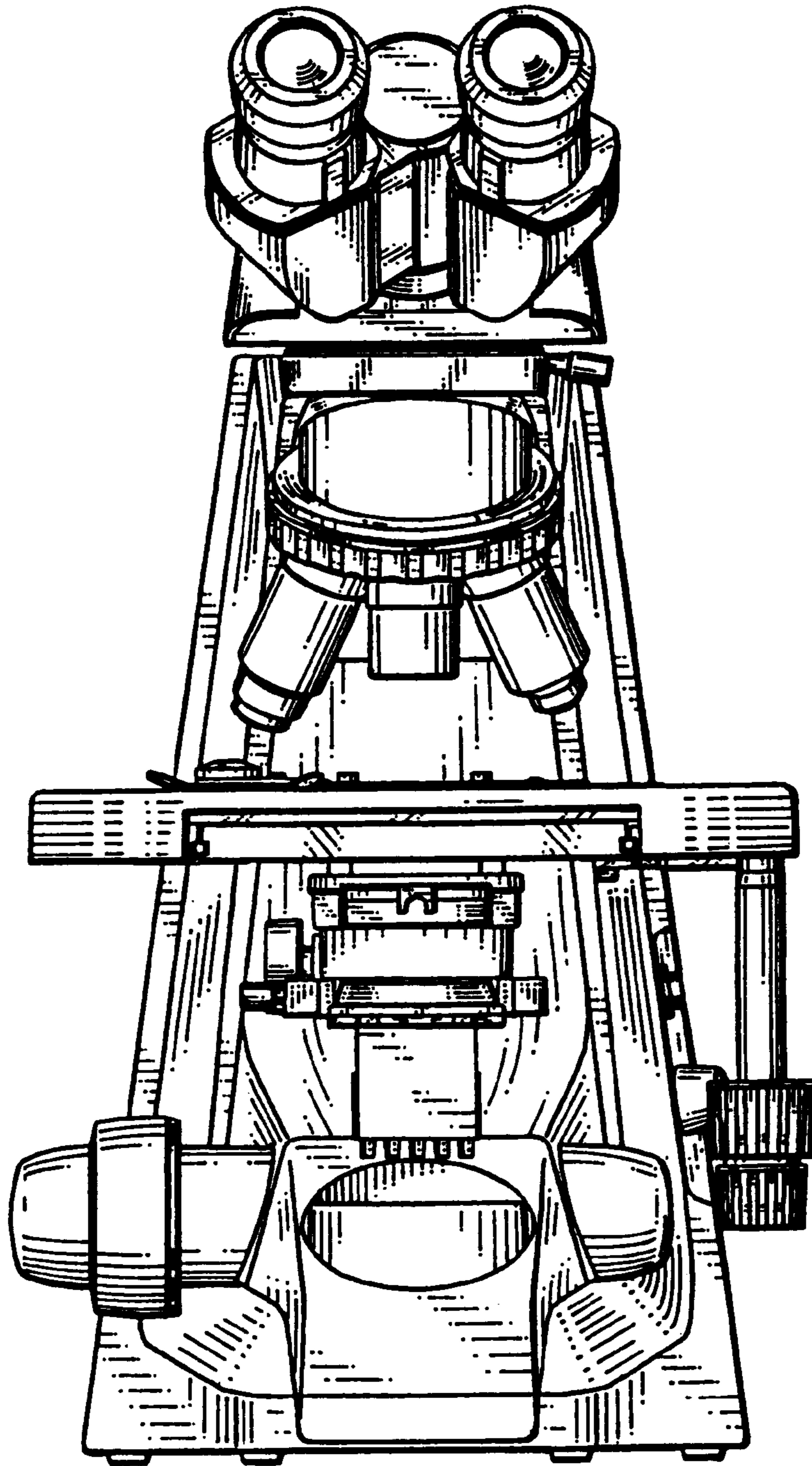

FIG. 3

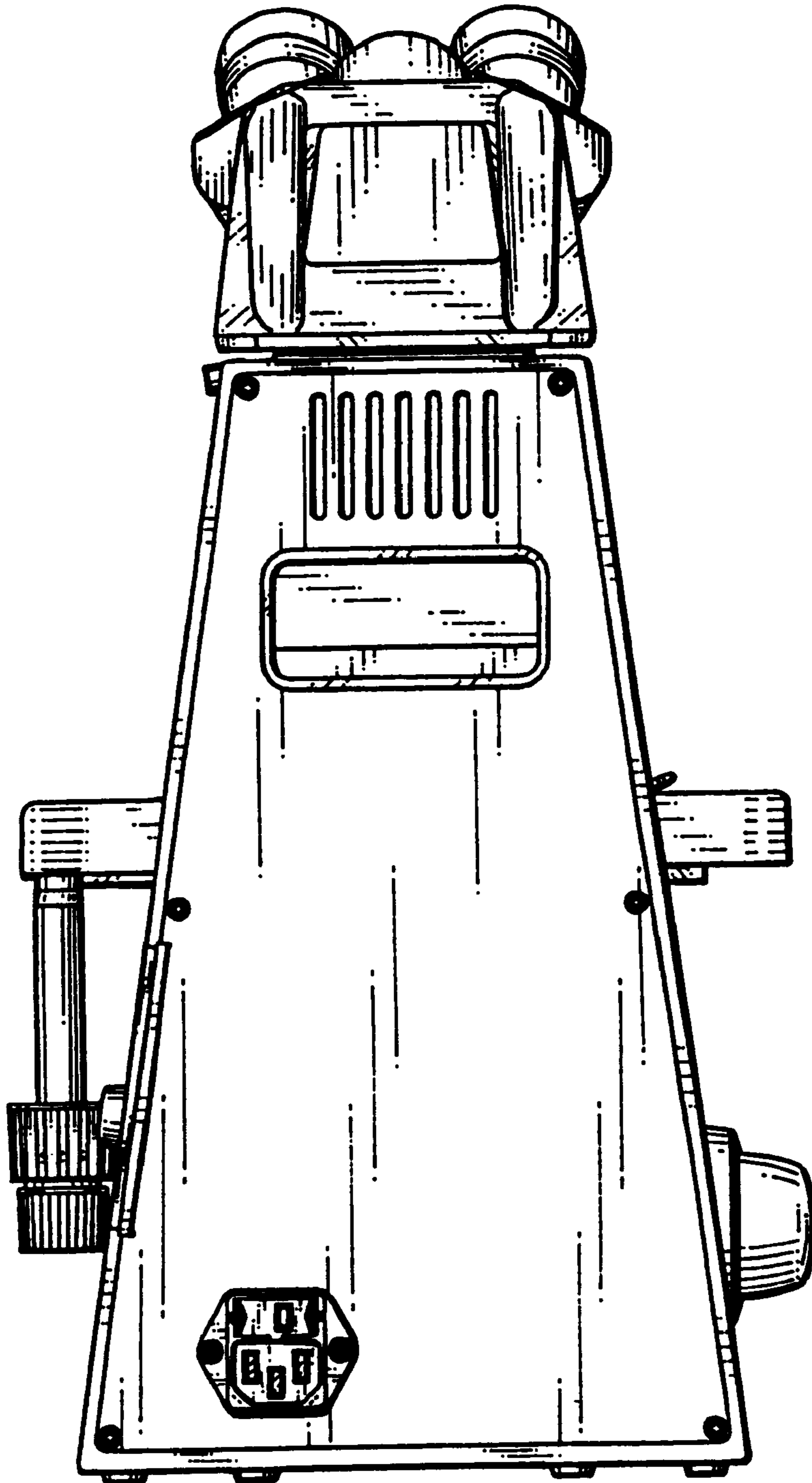

FIG. 4

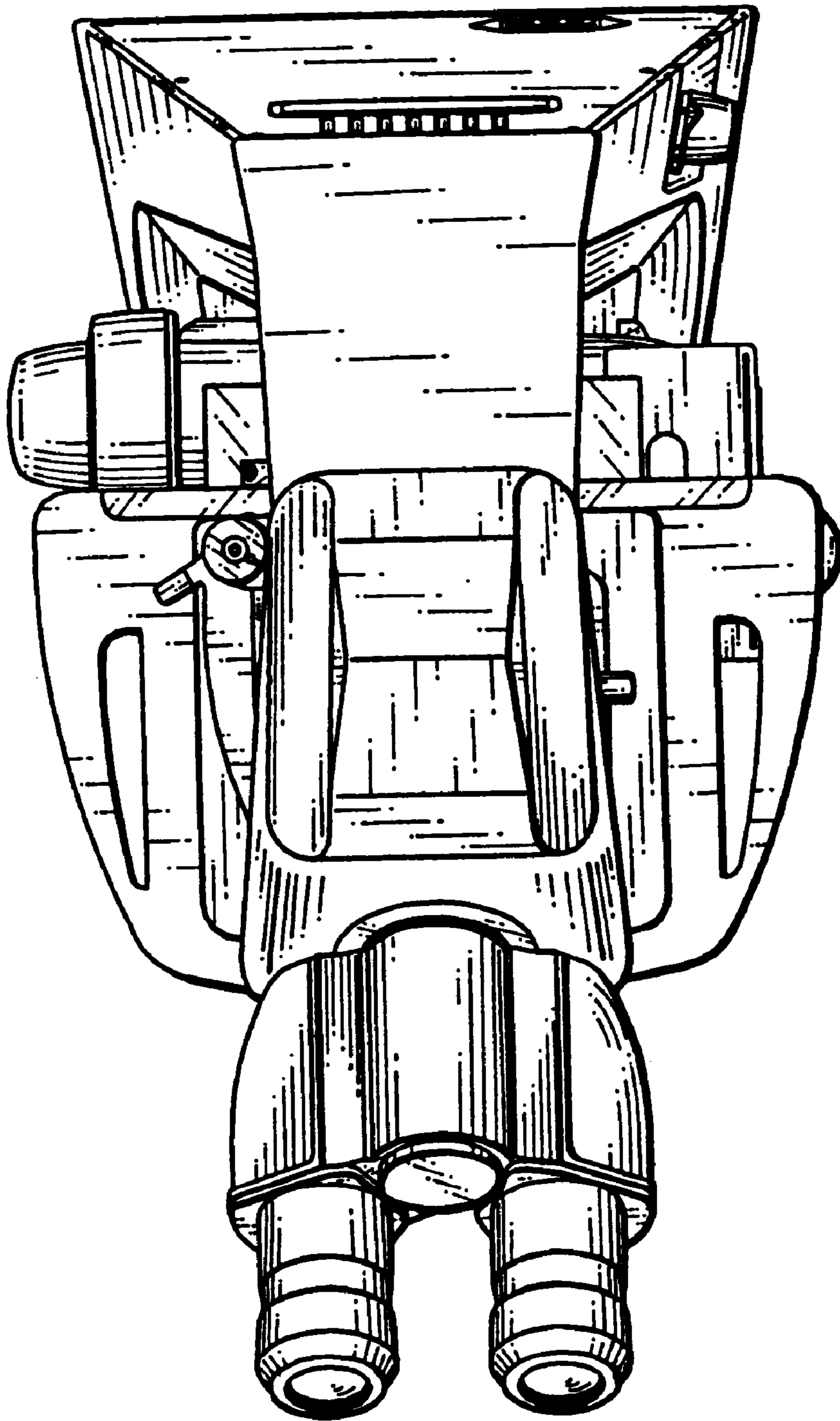

FIG. 5

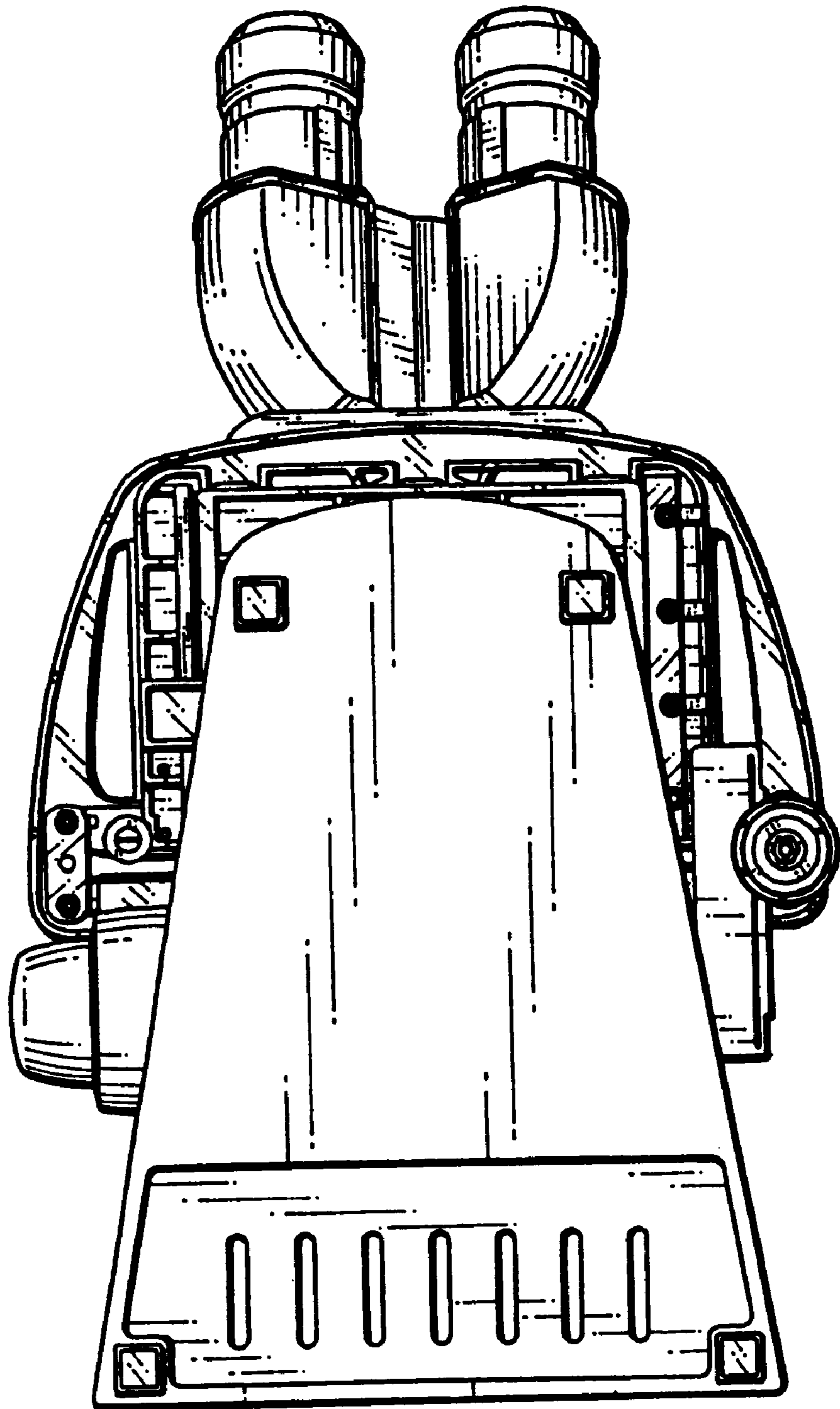

FIG. 6

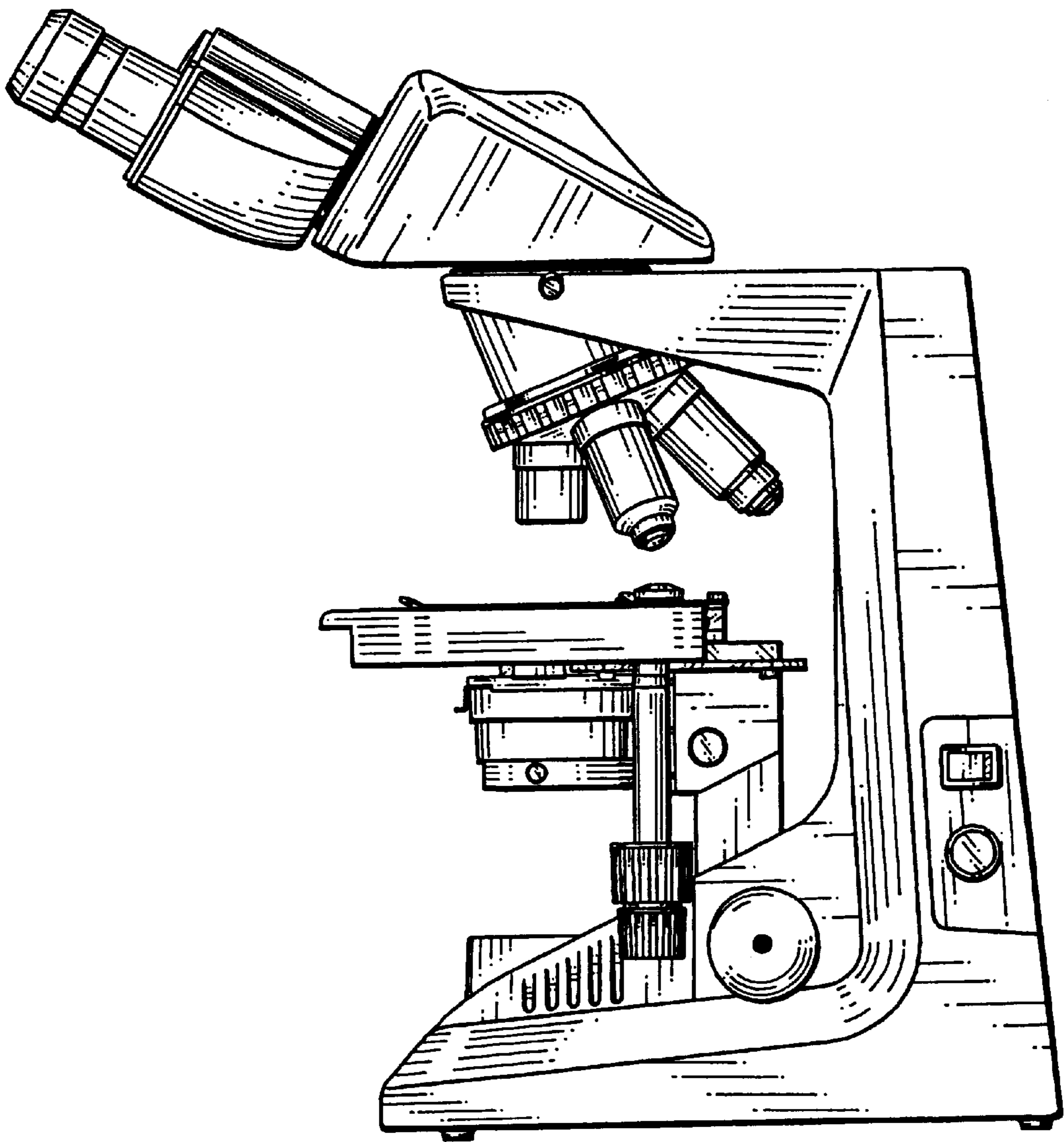

FIG. 7

