



US00D436917S

(12) **United States Design Patent**  
**Hayakawa et al.**

(10) **Patent No.:** **US D436,917 S**

(45) **Date of Patent:** **\*\* Jan. 30, 2001**

(54) **BATTERY PACK**

5,197,889 \* 3/1993 Rizzo et al. .... 429/99 X  
5,977,746 \* 11/1999 Hershberger et al. .... 429/100 X

(75) Inventors: **Naohiro Hayakawa; Yoichi Kato;**  
**Takao Kuroyanagi; Shingo Umemura,**  
all of Anjo (JP)

\* cited by examiner

(73) Assignee: **Makita Corporation, Anjo (JP)**

*Primary Examiner*—Joel Sincavage  
(74) *Attorney, Agent, or Firm*—Dennison, Scheiner,  
Schultz & Wakeman

(\*\*) Term: **14 Years**

(57) **CLAIM**

(21) Appl. No.: **29/122,955**

The ornamental design for a battery pack, as shown and described.

(22) Filed: **May 8, 2000**

(30) **Foreign Application Priority Data**

**DESCRIPTION**

Nov. 17, 1999 (JP) ..... 11-31844  
Nov. 17, 1999 (JP) ..... 11-31845

FIG. 1 is a perspective view of a battery pack showing my new design;

(51) **LOC (7) Cl.** ..... **13-02**

FIG. 2 is a front elevation view thereof;

(52) **U.S. Cl.** ..... **D13/103**

FIG. 3 is a rear elevation view thereof;

(58) **Field of Search** ..... D13/103, 119;  
429/96-100, 159, 163, 176, 186

FIG. 4 is a left side elevation view thereof;

FIG. 5 is a right side elevation view thereof;

FIG. 6 is a top plan view thereof;

FIG. 7 is a bottom plan view thereof;

FIG. 8 is a perspective view of a second embodiment of the battery pack shown in FIG. 1;

FIG. 9 is a front elevation view thereof;

FIG. 10 is a rear elevation view thereof;

FIG. 11 is a left side elevation view thereof;

FIG. 12 is a right side elevation view thereof;

FIG. 13 is a top plan view thereof; and,

FIG. 14 is a bottom plan view thereof.

(56) **References Cited**

**U.S. PATENT DOCUMENTS**

- D. 280,717 \* 9/1985 Scheid et al. .... D13/103
- D. 304,026 \* 10/1989 Goodner et al. .... D13/103
- D. 329,649 \* 9/1992 Stamps, Jr. et al. .... D13/103 X
- D. 346,582 \* 5/1994 Sands et al. .... D13/103
- D. 379,795 \* 6/1997 Pitzen et al. .... D13/103
- D. 413,564 \* 9/1999 Hershberger et al. .... D13/103
- D. 415,099 10/1999 Willkens et al. .
- D. 415,100 10/1999 Buck .

**1 Claim, 10 Drawing Sheets**

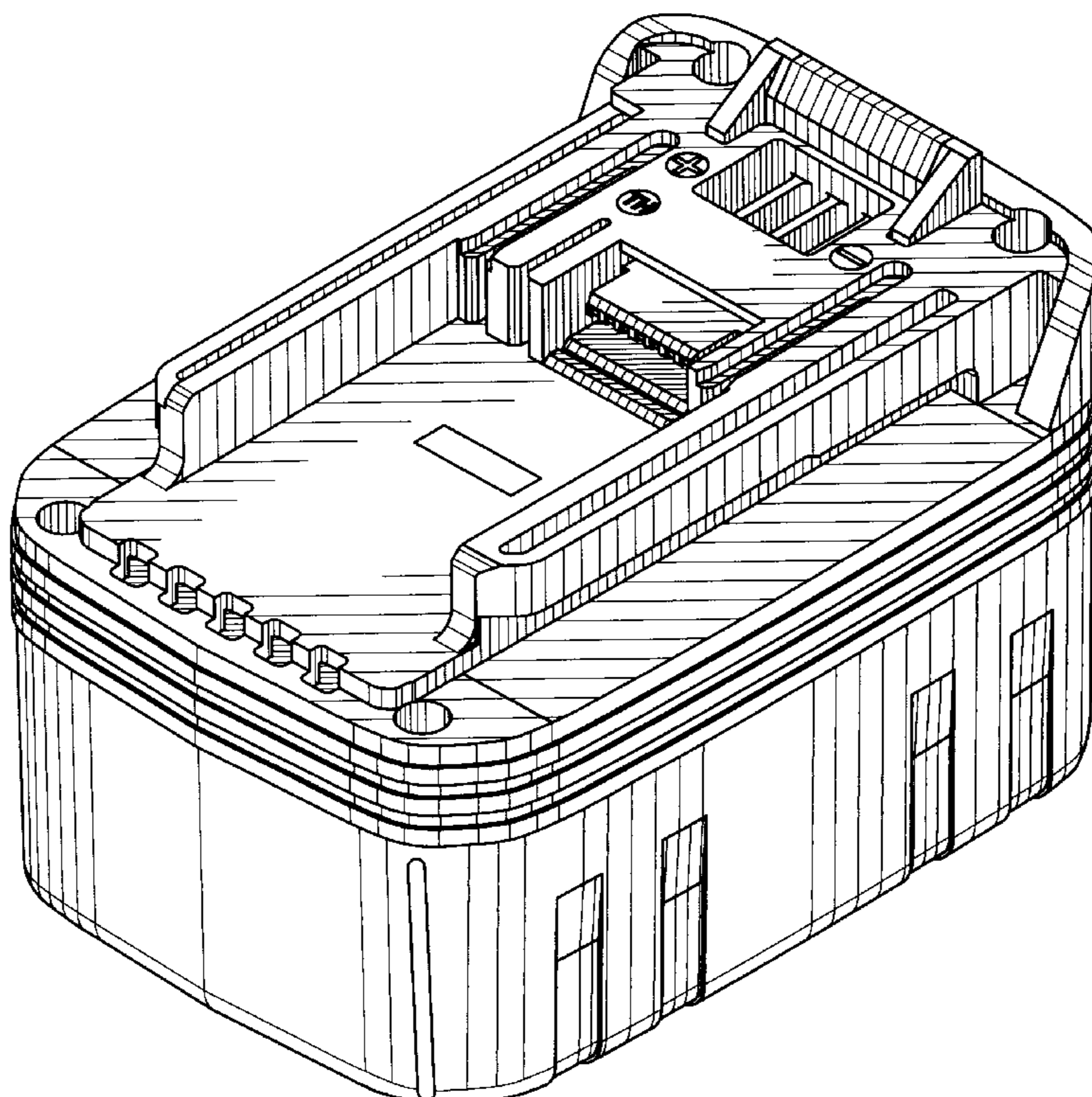

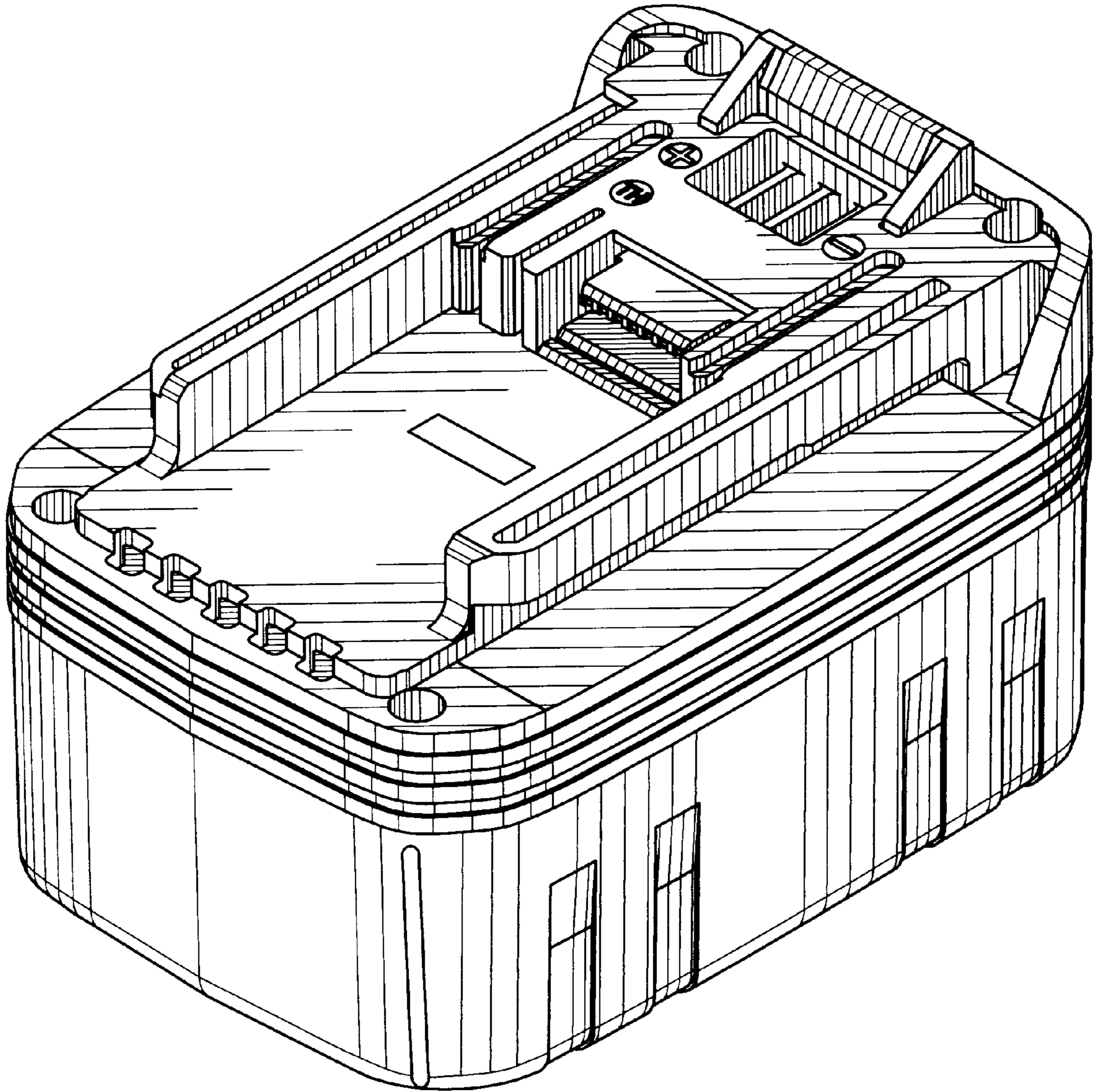

FIG. 1

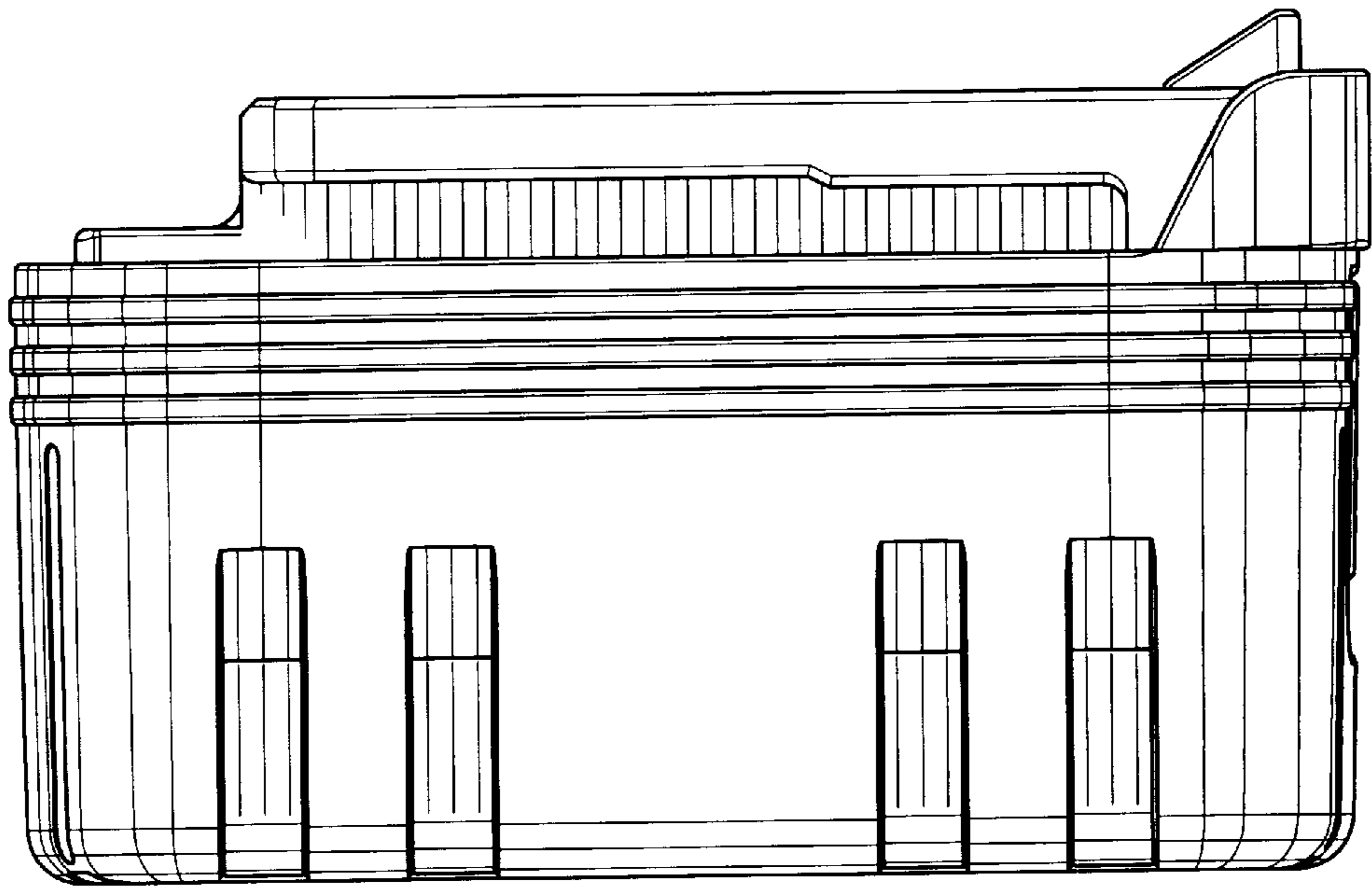

FIG. 2

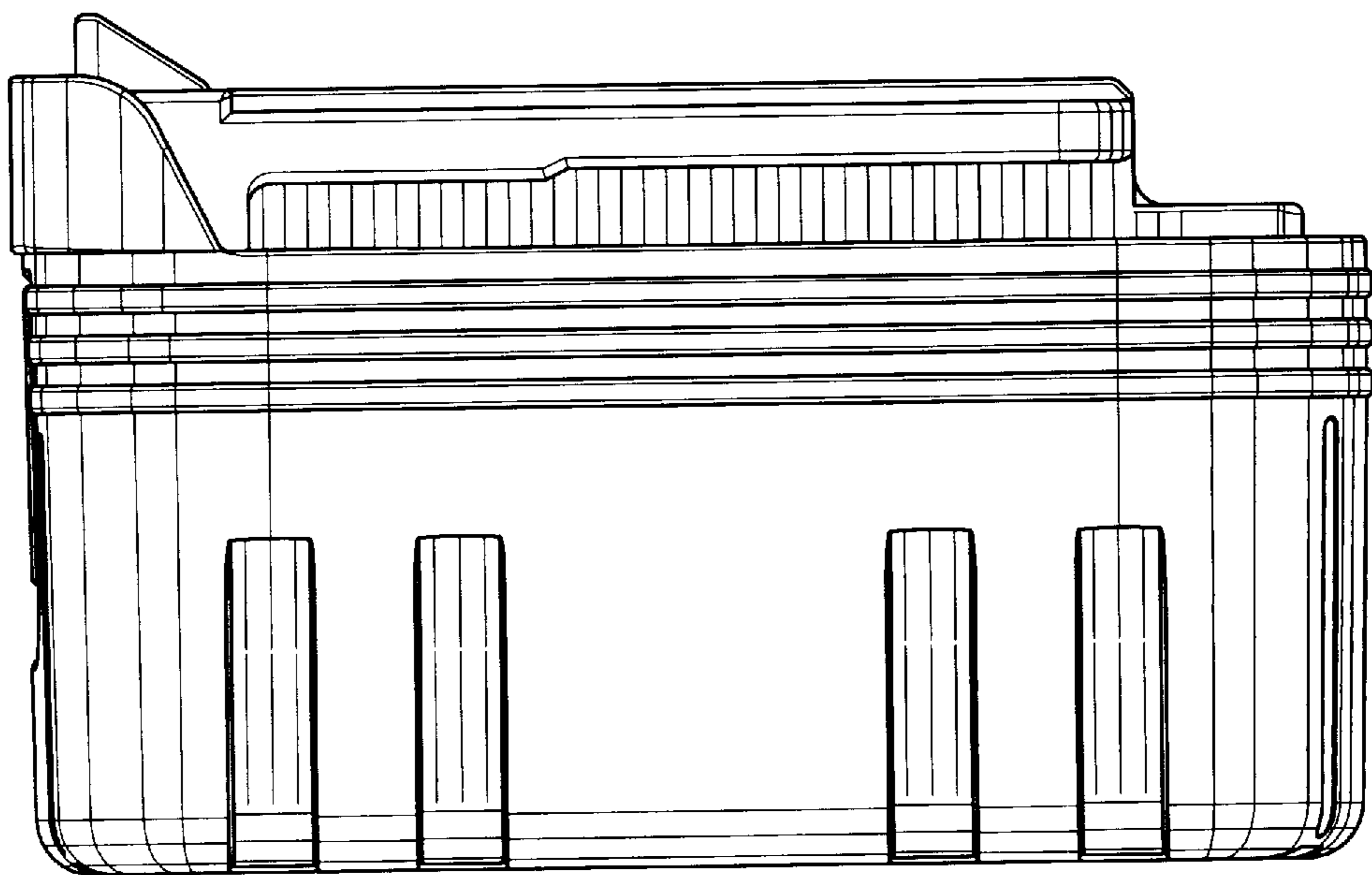

FIG. 3

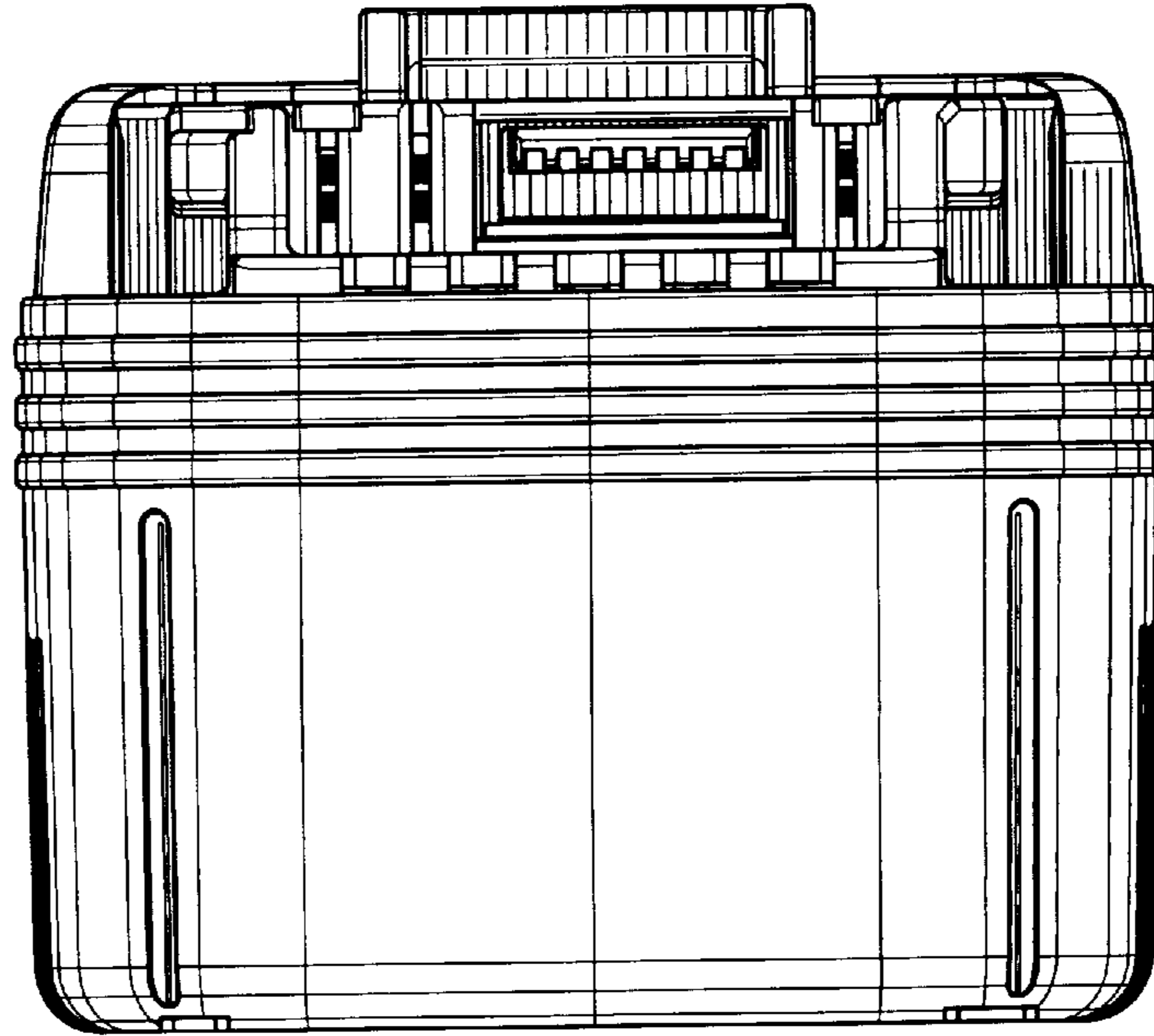

FIG. 4

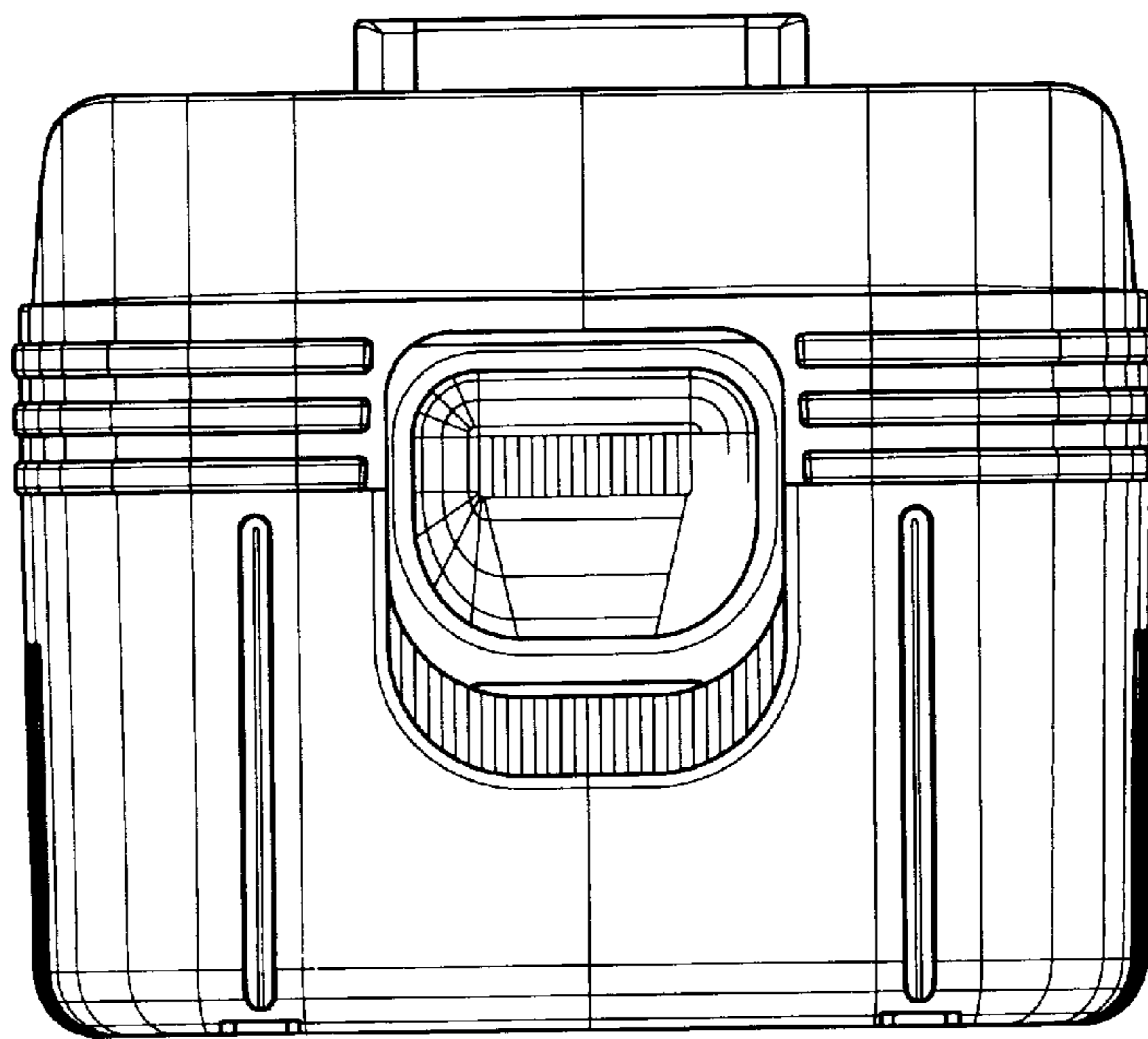

FIG. 5

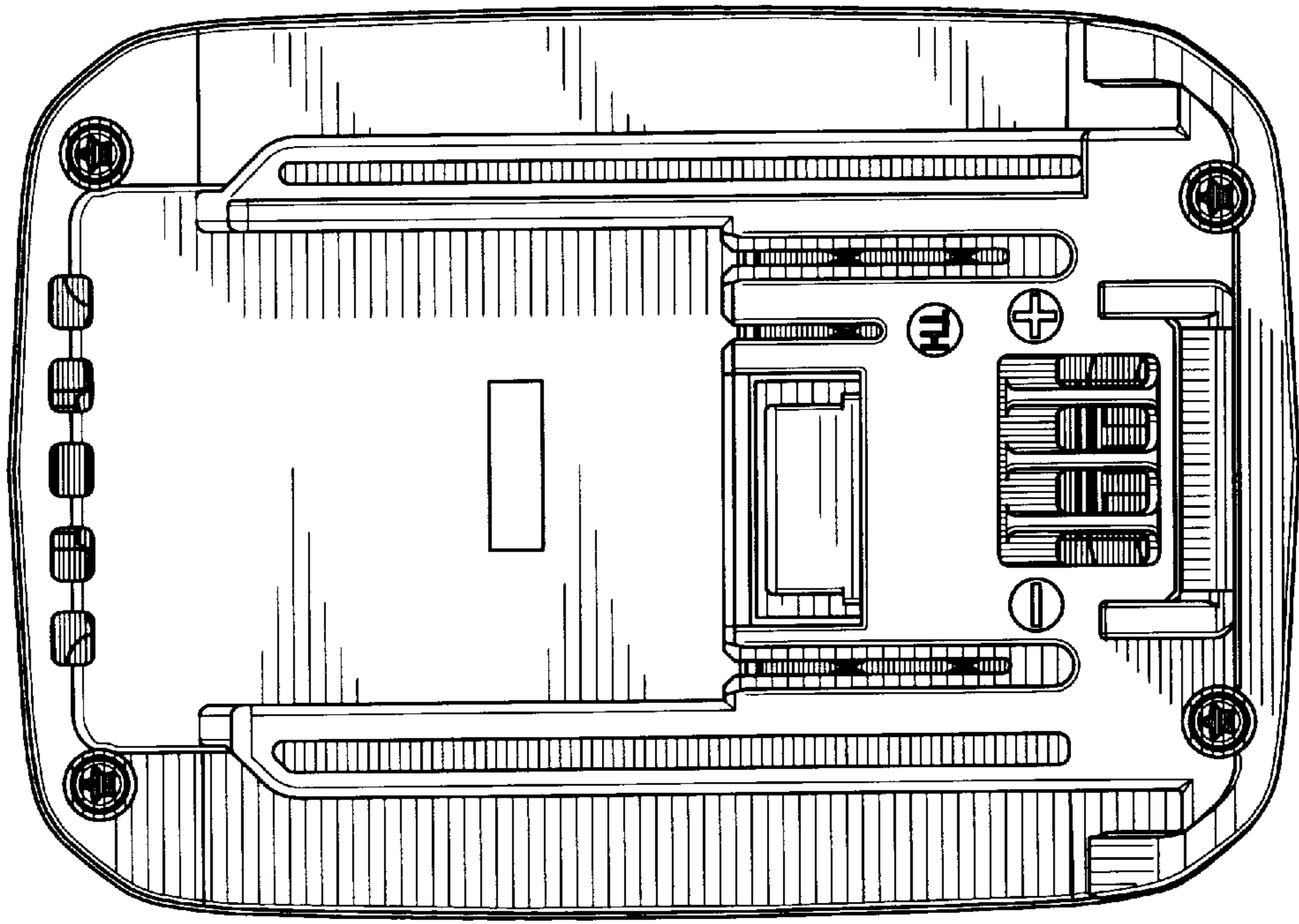

FIG. 6

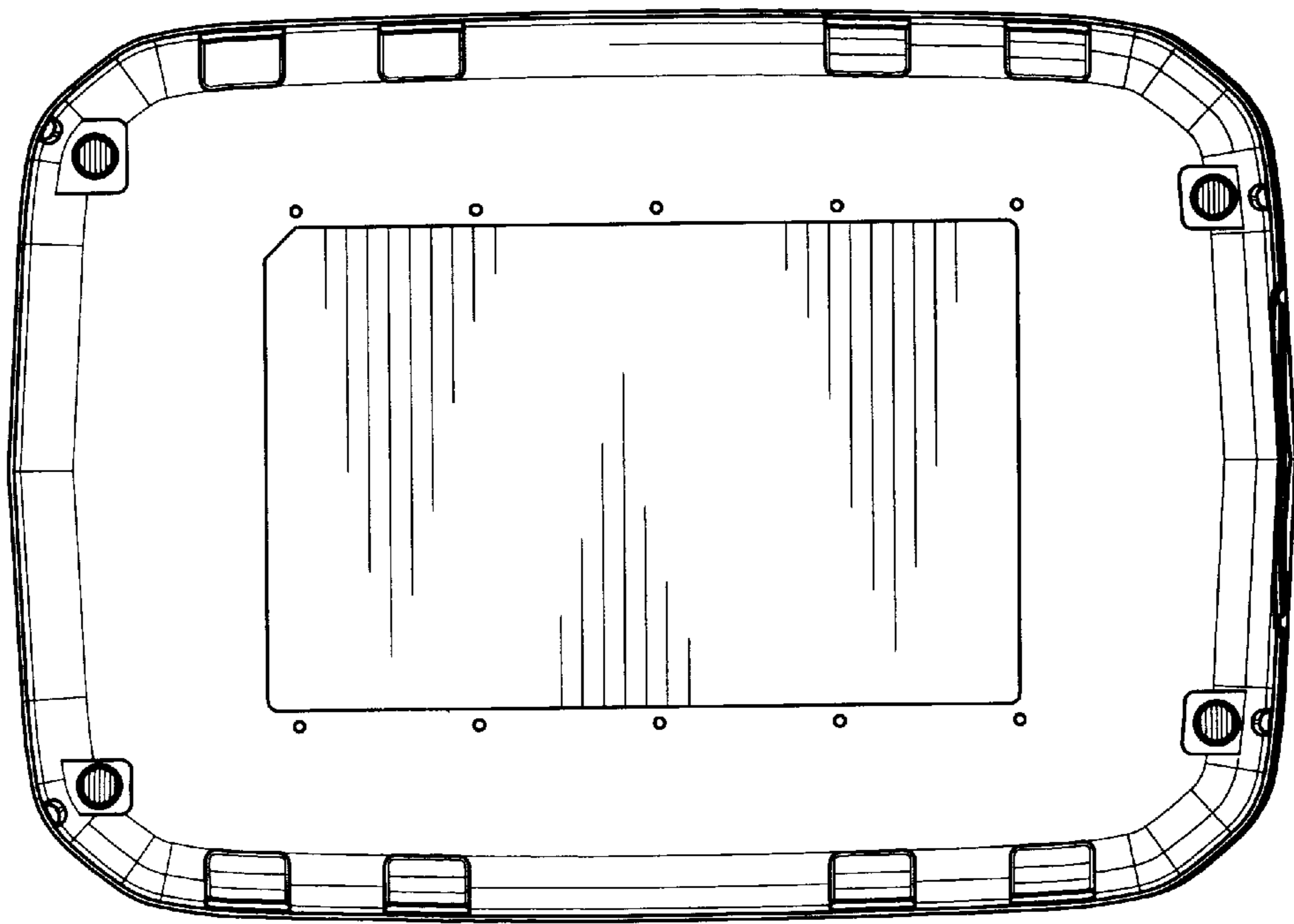

FIG. 7

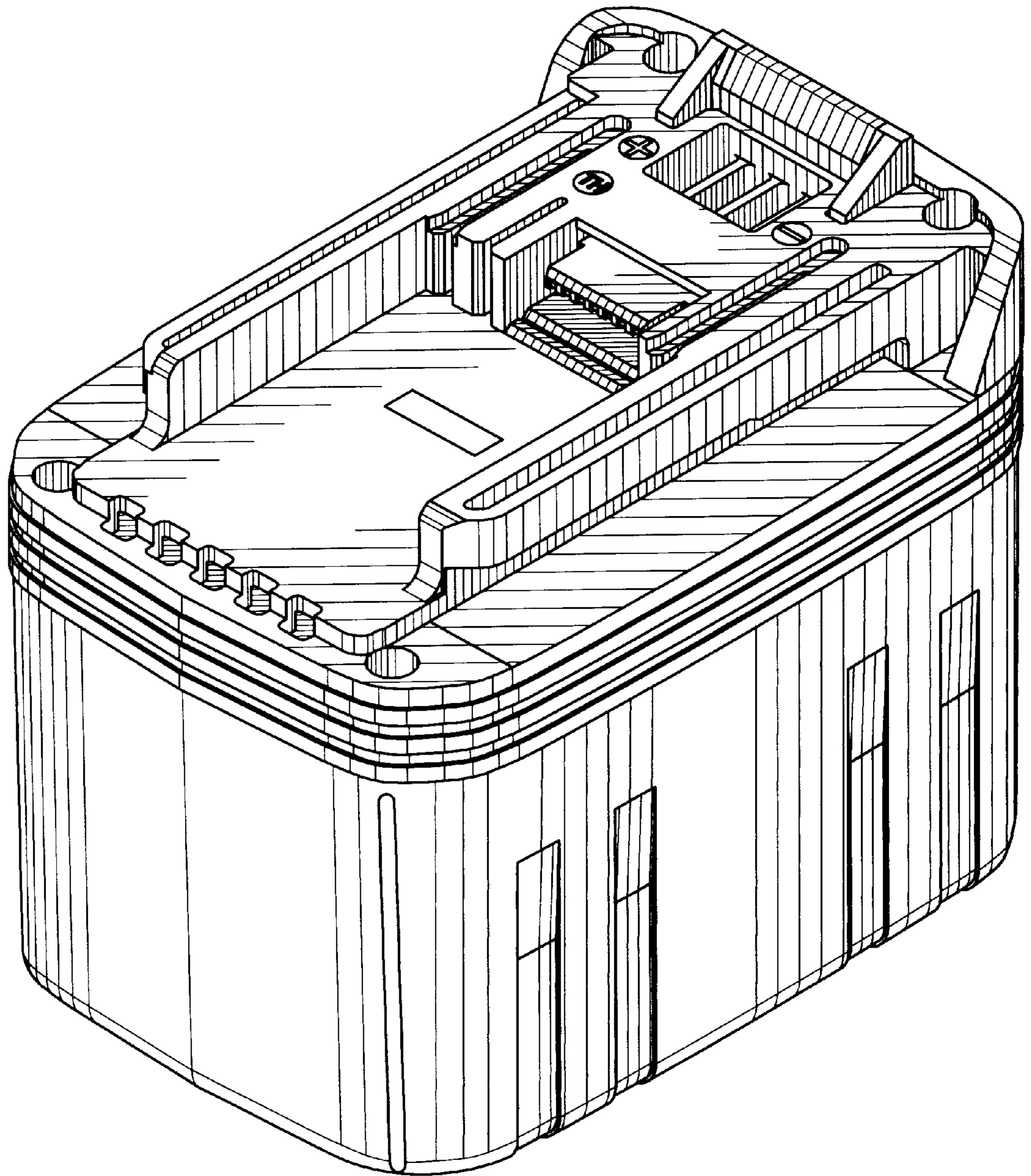

FIG. 8

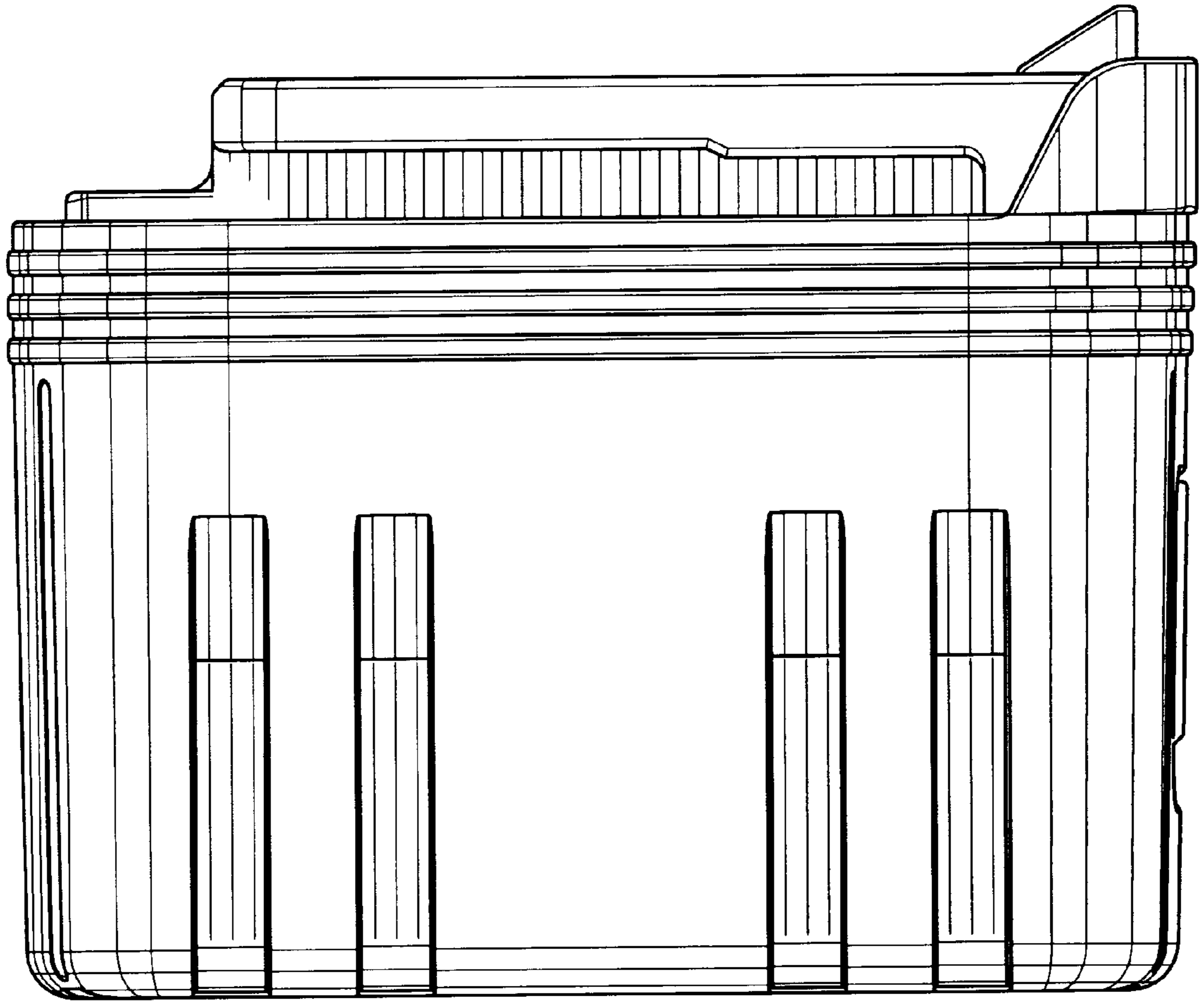

FIG. 9

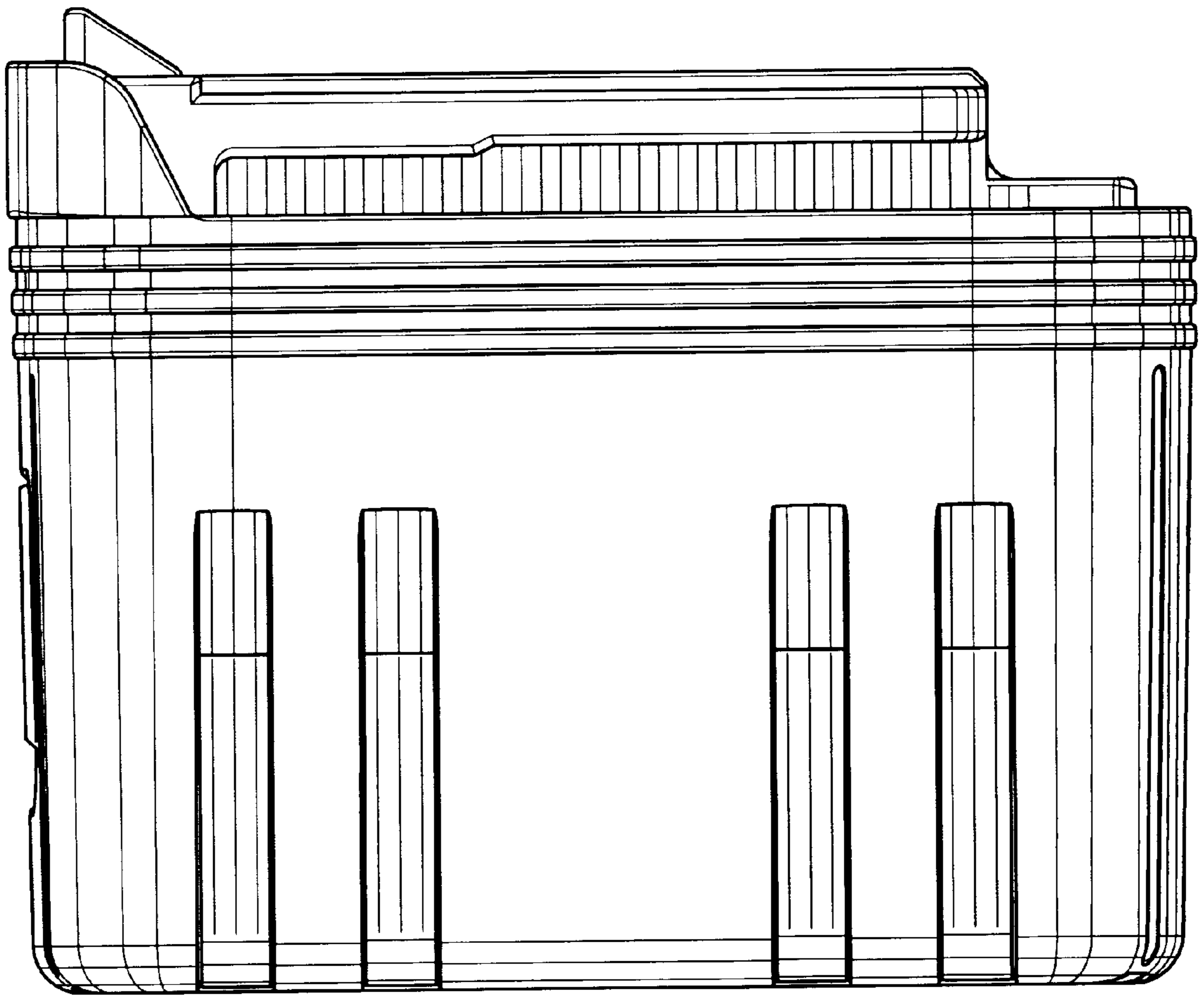

FIG. 10



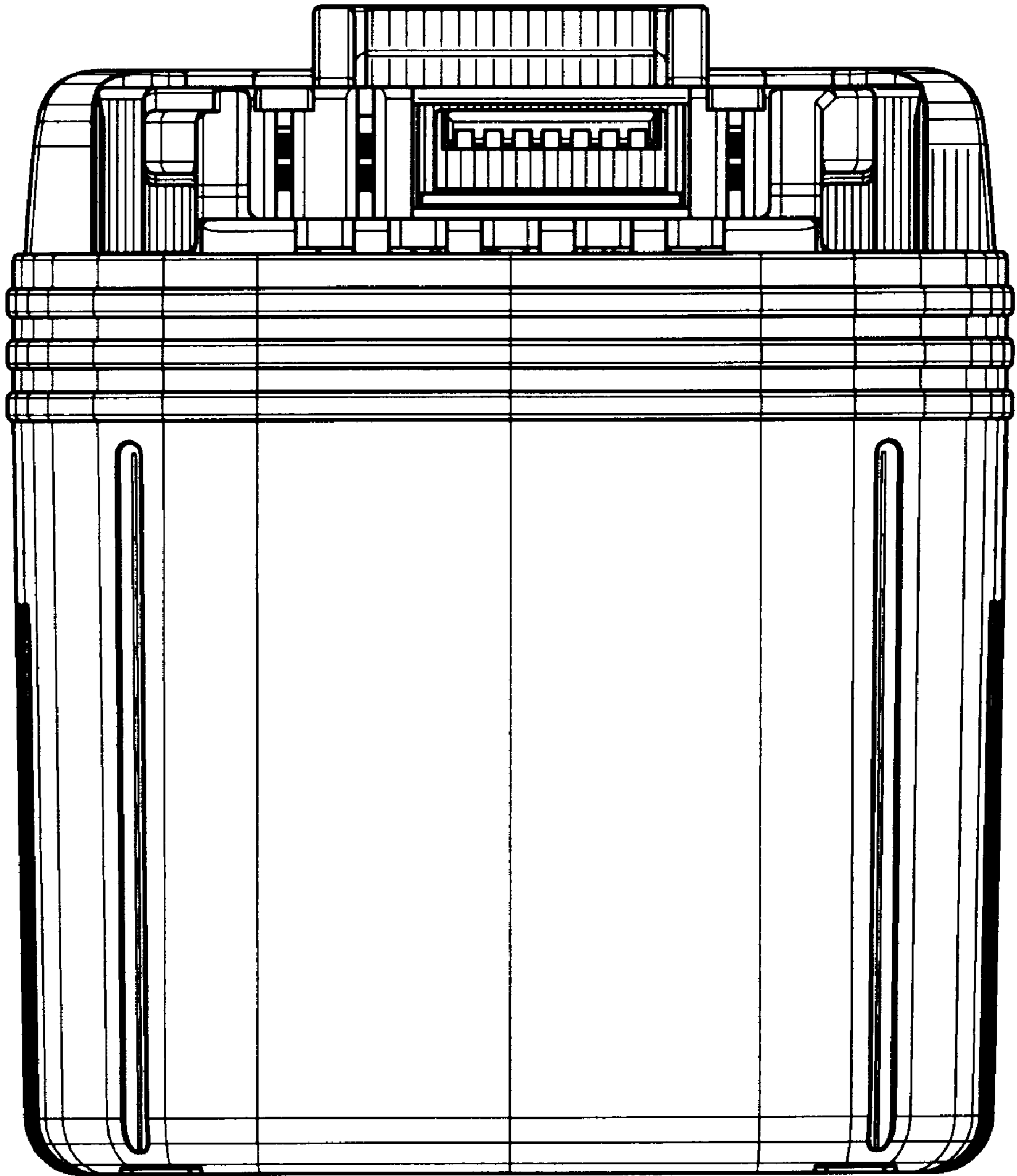

FIG. 11

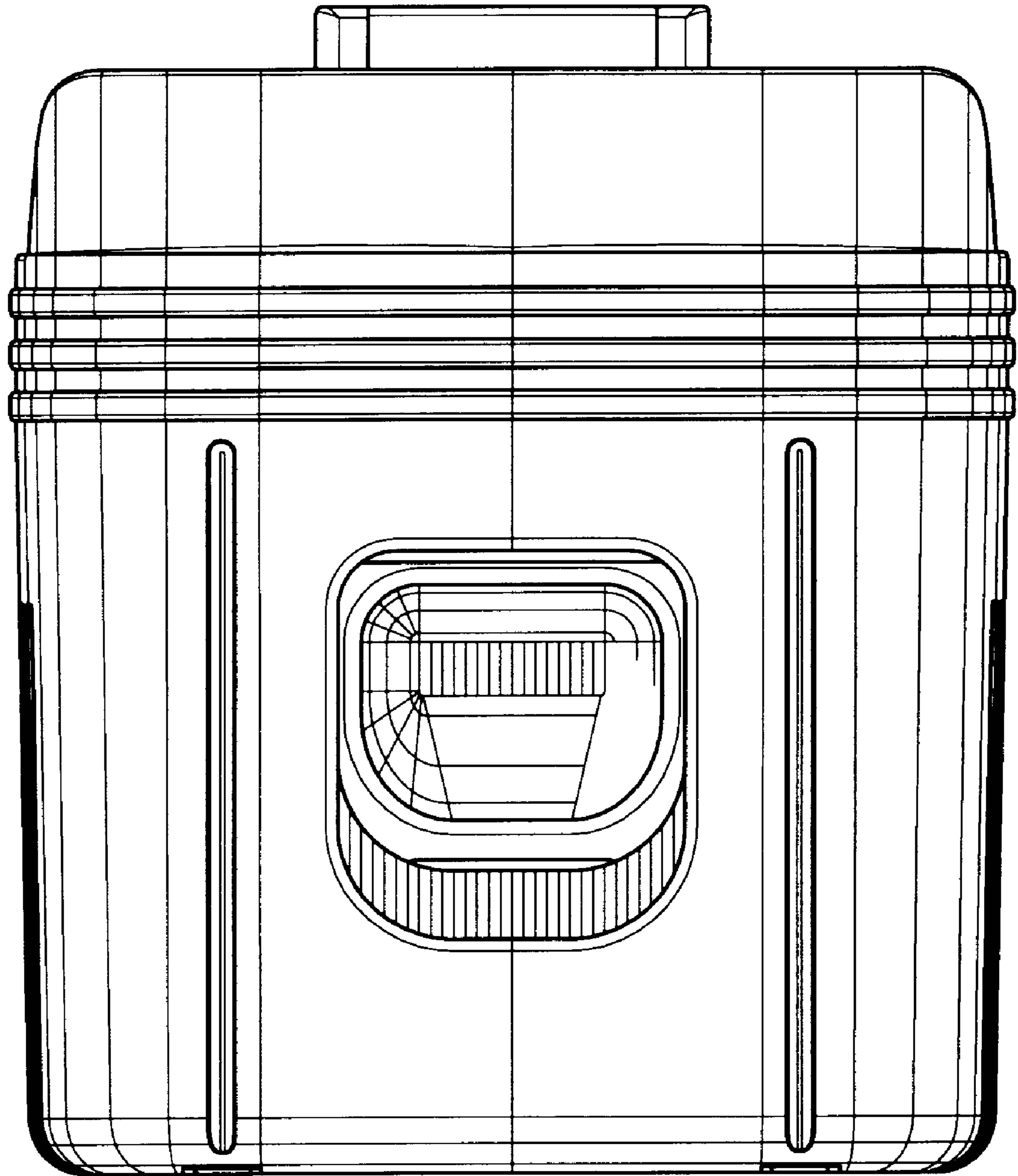

FIG. 12

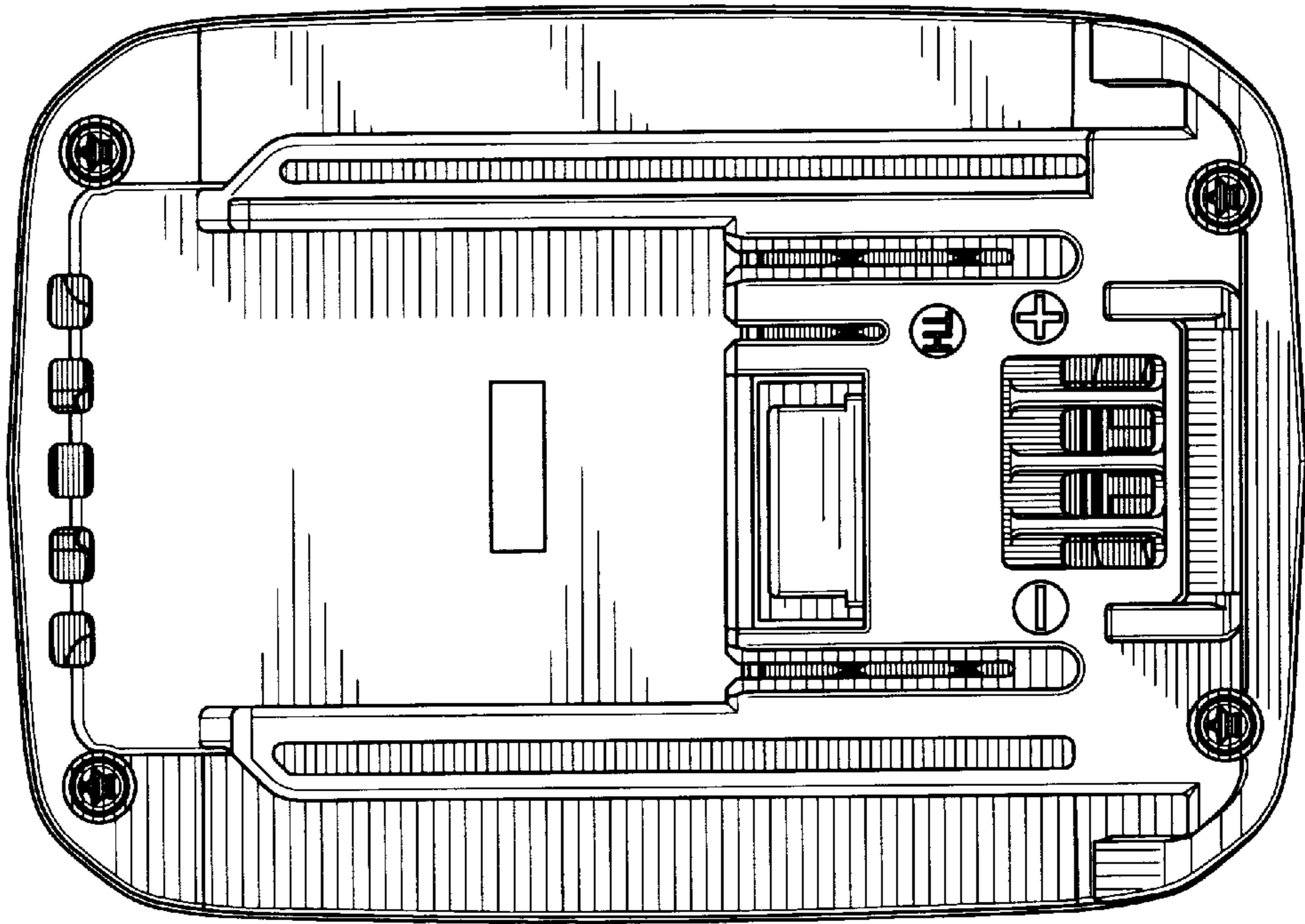

FIG. 13

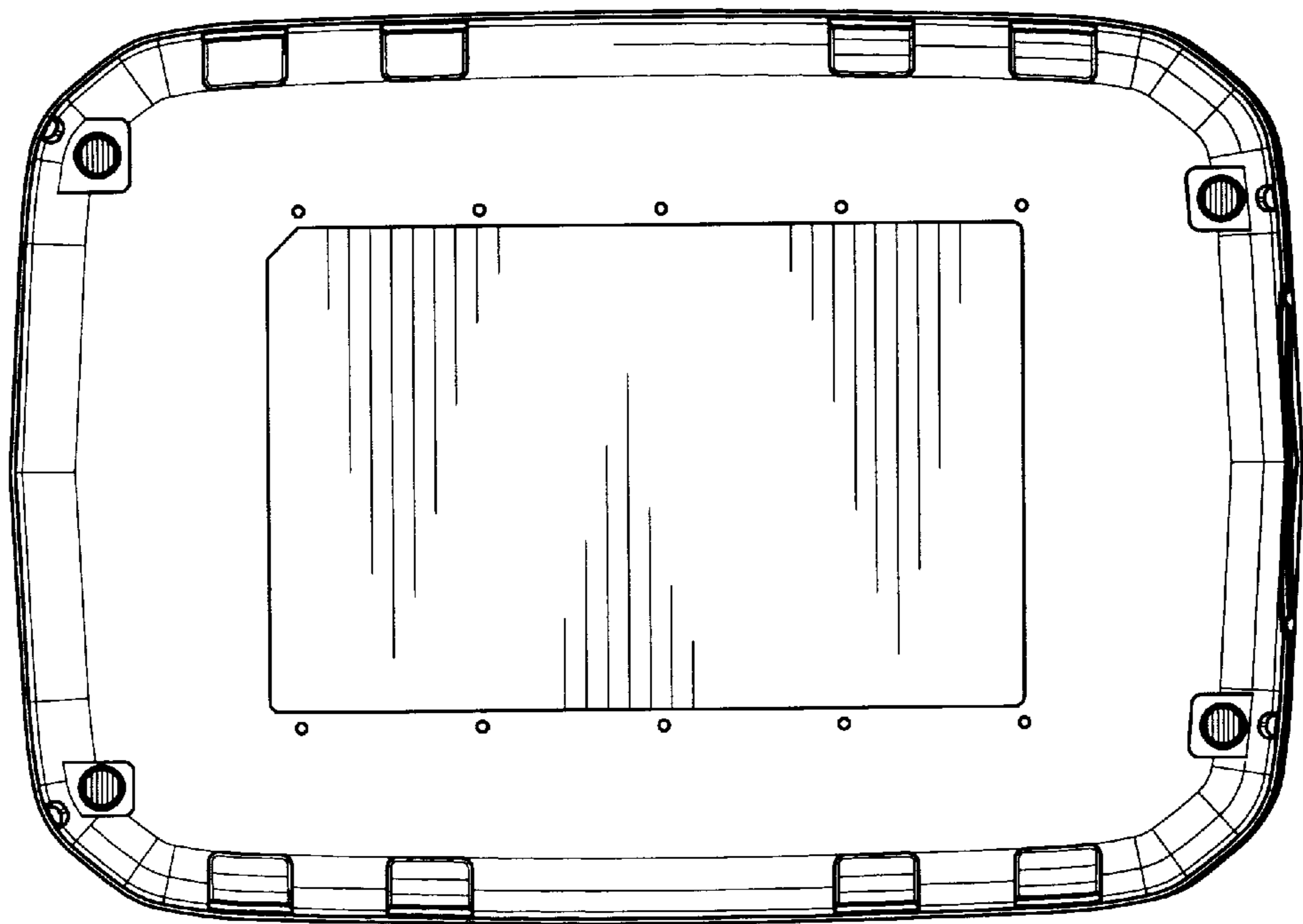

FIG. 14