



US00D436786S

(12) **United States Design Patent**
Solomon

(10) **Patent No.:** **US D436,786 S**

(45) **Date of Patent:** **** Jan. 30, 2001**

(54) **CD RACK**

(75) **Inventor:** **Peter Solomon, Milan (IT)**

(73) **Assignee:** **Ezech Limited, Kowloon (HK)**

(**) **Term:** **14 Years**

(21) **Appl. No.:** **29/103,204**

(22) **Filed:** **Apr. 9, 1999**

(51) **LOC (7) Cl.** **06-04**

(52) **U.S. Cl.** **D6/629; D6/453**

(58) **Field of Search** D6/407, 626-630,
D6/462-468, 450, 453, 466-467, 475, 476;
312/9.1-9.64; D32/55, 58; 211/40, 41.1,
41.2, 41.3, 41.4, 42, 41.12, 41.18; 206/307.1,
307, 308.1, 445, 387.15, 454, 387.1, 425;
D11/160; D19/90; D12/193, 200

(56) **References Cited**

U.S. PATENT DOCUMENTS

- D. 059,459 * 10/1921 Davidovits D11/160
- D. 060,734 * 3/1922 Regan D11/160
- D. 069,502 * 2/1926 Drucklieb D11/160 X
- D. 108,558 * 2/1938 Bergen et al. D20/31
- D. 143,267 * 12/1945 Burtis D11/160 X
- D. 260,588 * 9/1981 Johnson, Sr. D6/453
- D. 299,361 * 1/1989 Lothe D19/90
- D. 304,462 * 11/1989 Evans D19/90
- D. 307,159 * 4/1990 Foran et al. D19/90
- D. 309,524 * 7/1990 Egly et al. D6/629
- D. 313,430 * 1/1991 Evenson D19/90
- D. 330,004 * 10/1992 Spencer D12/193
- D. 330,185 * 10/1992 Spencer D12/200
- D. 333,119 * 2/1993 Russell D12/193

- D. 339,825 * 9/1993 Hwang D19/90
- D. 341,376 * 11/1993 Feer D19/90
- D. 353,158 * 12/1994 Evenson D19/90
- D. 358,602 * 5/1995 Bilson D18/48
- 4,399,912 * 8/1983 Mollen et al. 206/387.15
- 4,684,027 * 8/1987 Wright 211/40
- 5,072,835 * 12/1991 Price, Jr. et al. 211/40

* cited by examiner

Primary Examiner—Jeffrey Asch

(74) *Attorney, Agent, or Firm*—Marguerite Del Valle

(57) **CLAIM**

The ornamental design for the CD rack, as shown and described.

DESCRIPTION

FIG. 1 is a is a front view of the new ornamental CD rack of the present invention.

FIG. 2 is a rear view thereof.

FIG. 3 is a top view thereof.

FIG. 4 is a is a bottom view thereof.

FIG. 5 is a right side view thereof, the left side being a mirror image.

FIG. 6 is a front right lower perspective view thereof.

FIG. 7 is a front right lower perspective view thereof, exploded with four dividers removed for clarity of illustration.

FIG. 8 is a front right lower perspective view thereof, showing some of the dividers reconfigured to an alternate position for use; and,

FIG. 9 is a side view of one divider shown separately for clarity of illustration, it being understood that the claim is directed to the complete CD rack of the present invention.

1 Claim, 7 Drawing Sheets

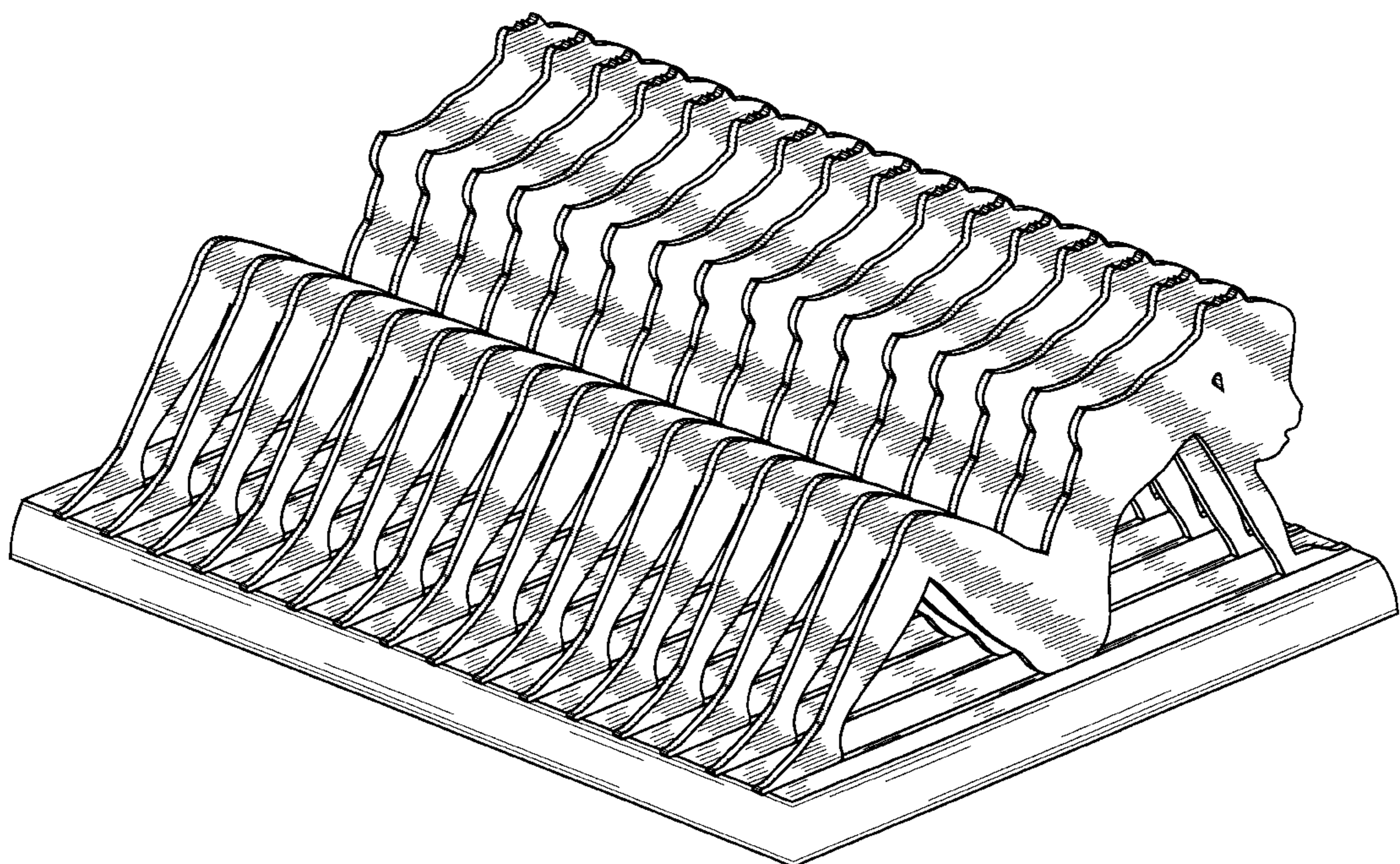

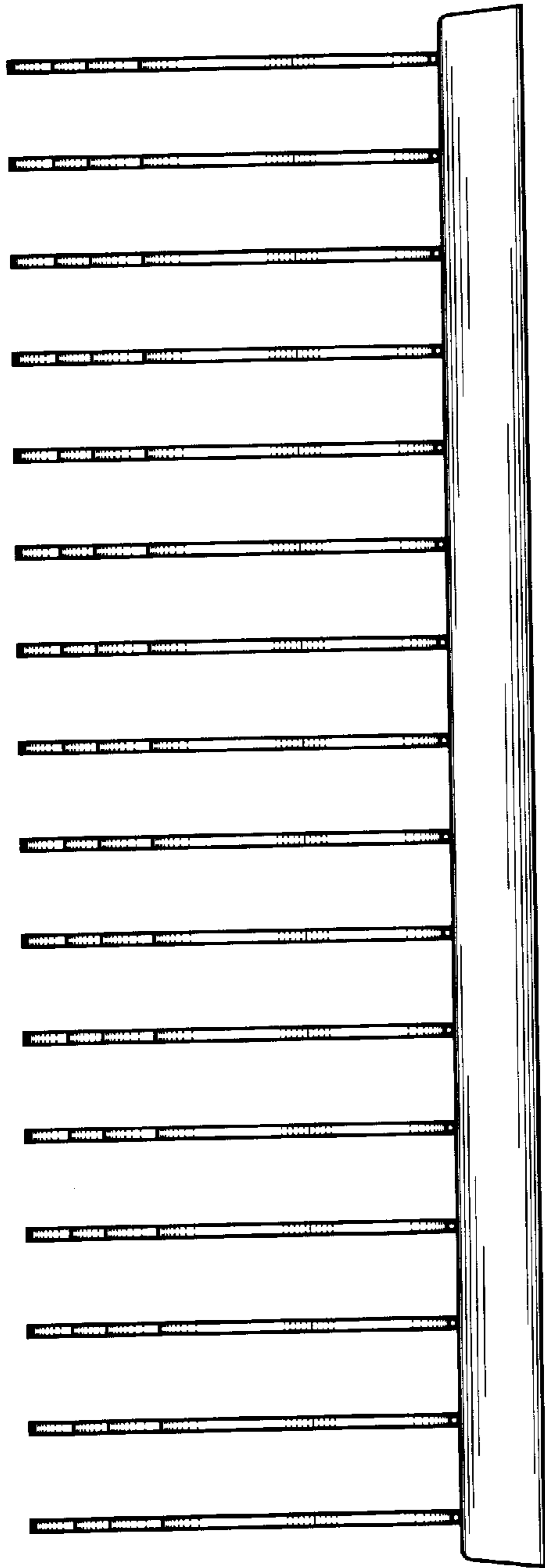

FIG. 1

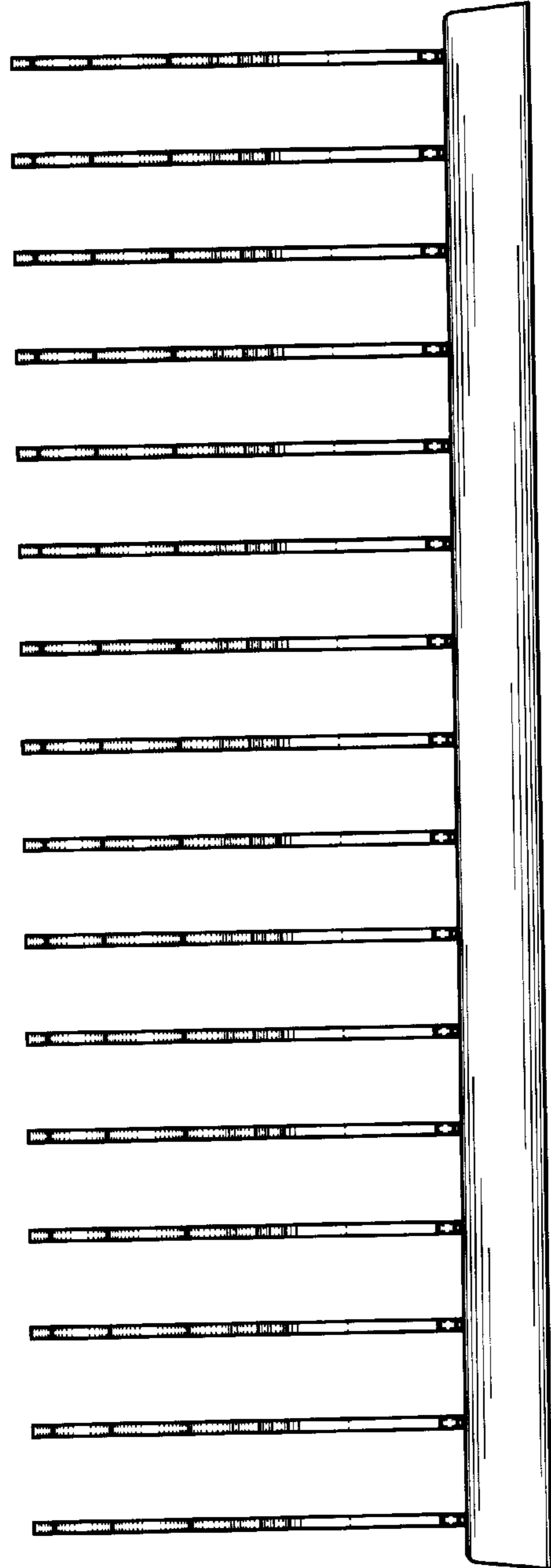

FIG. 2

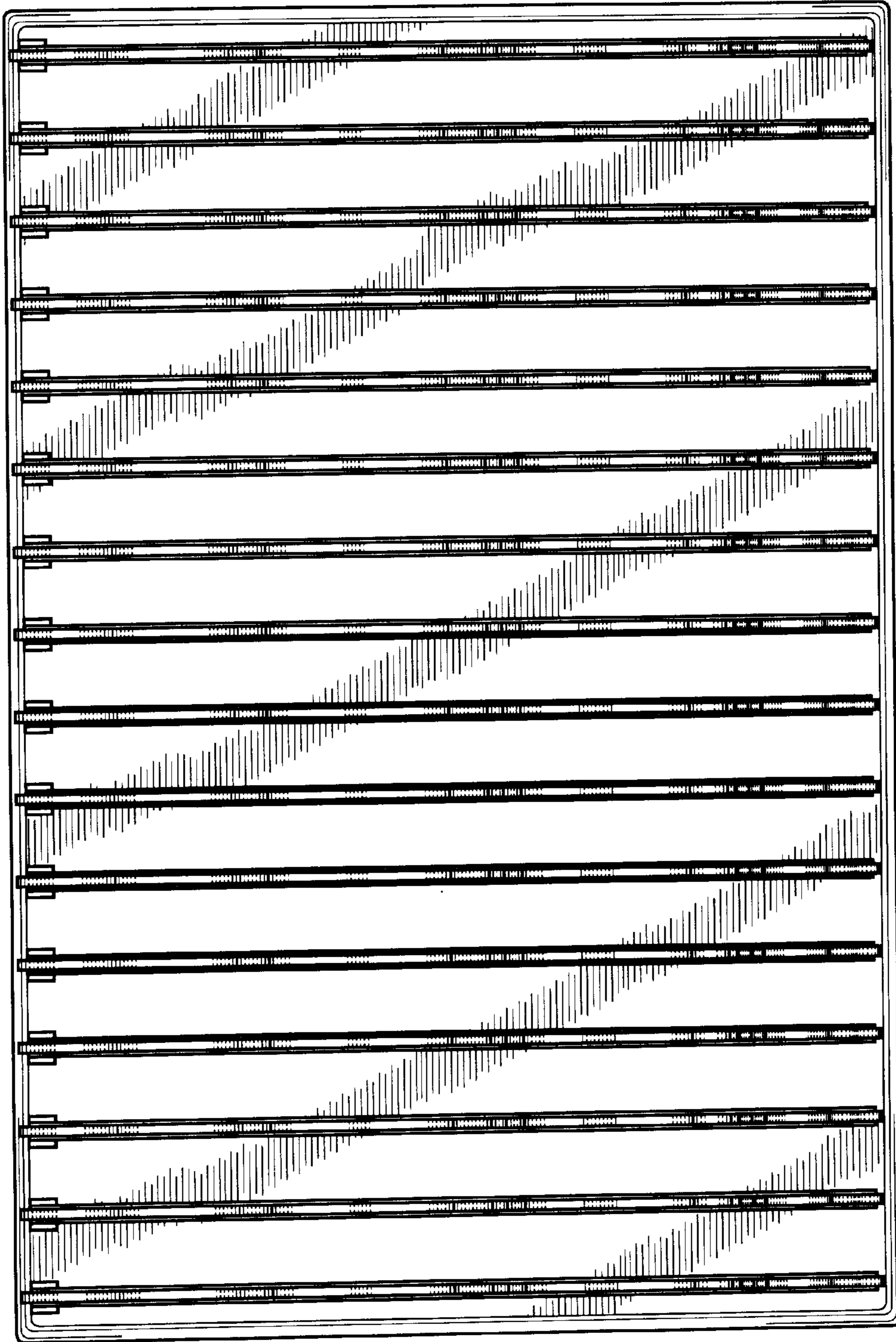

FIG. 3

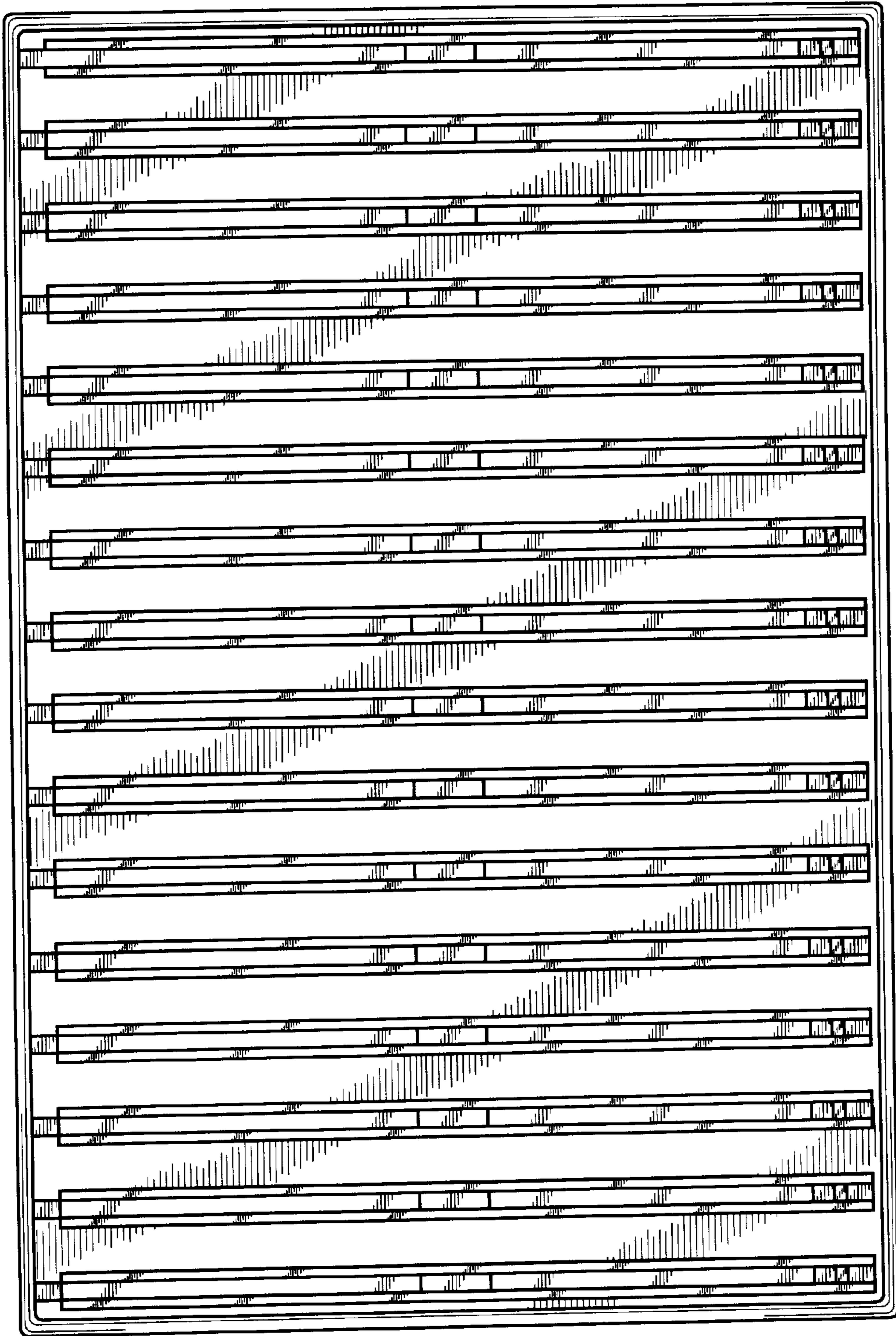

FIG. 4

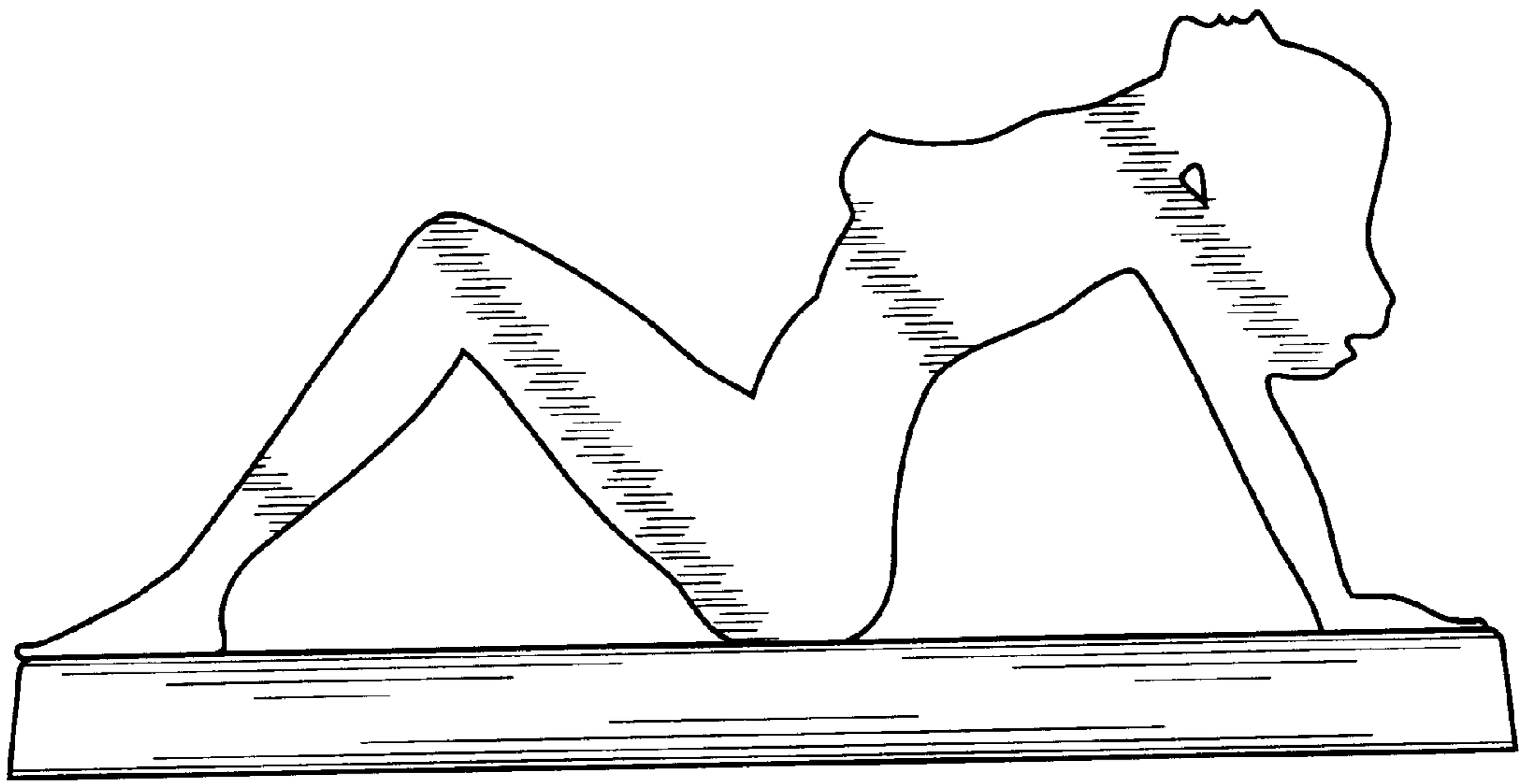

FIG. 5

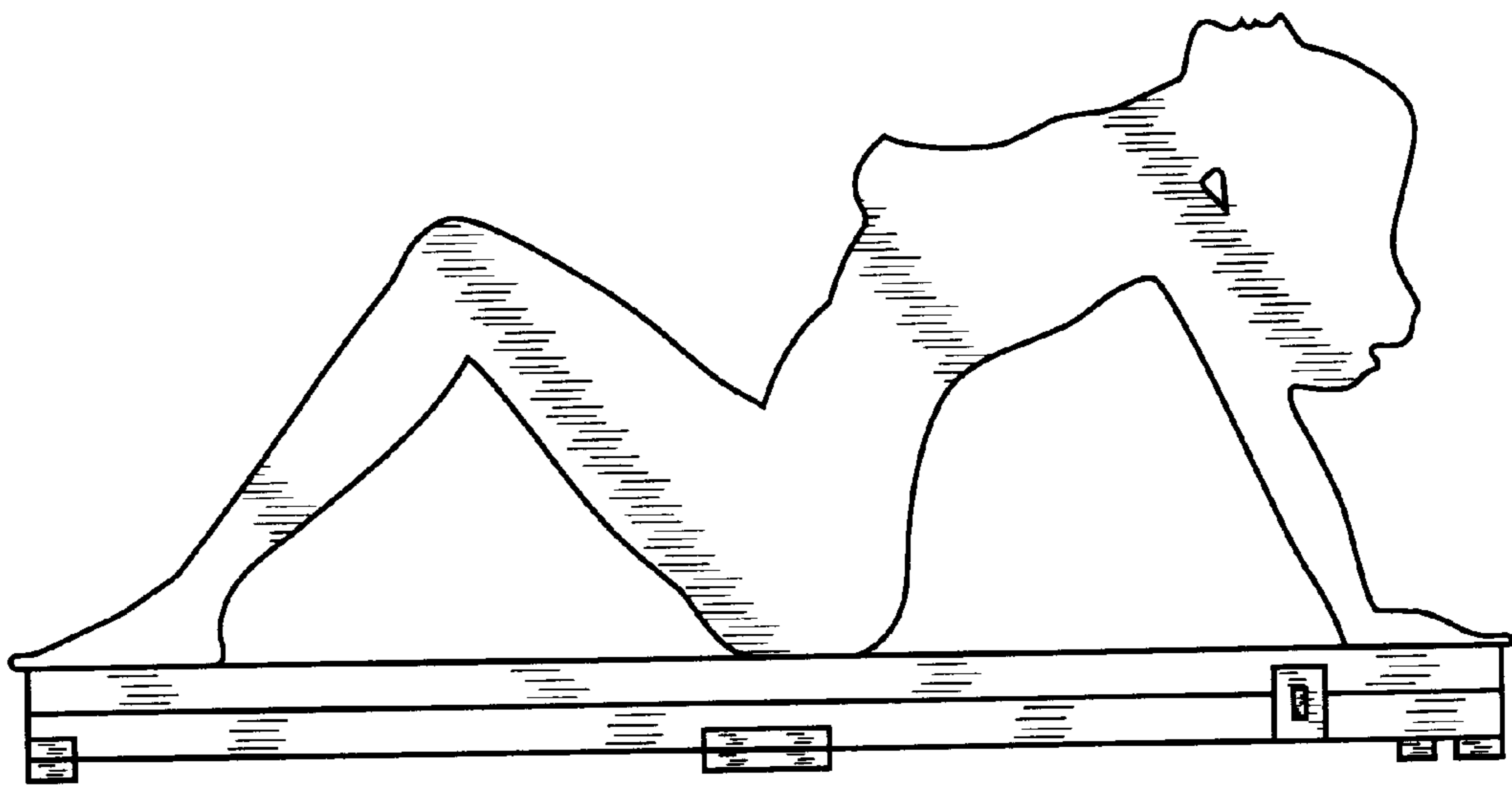

FIG. 9

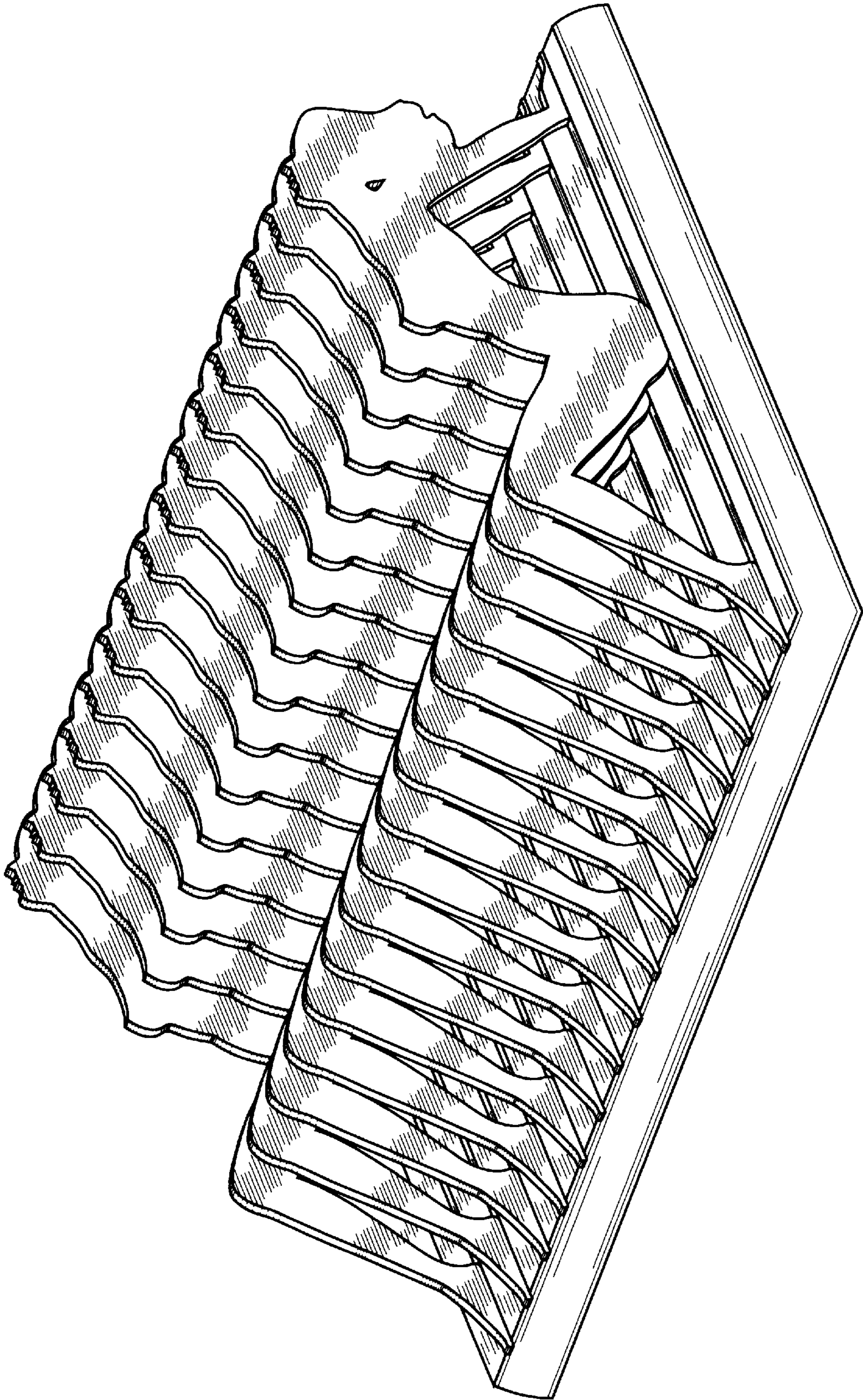

FIG. 6

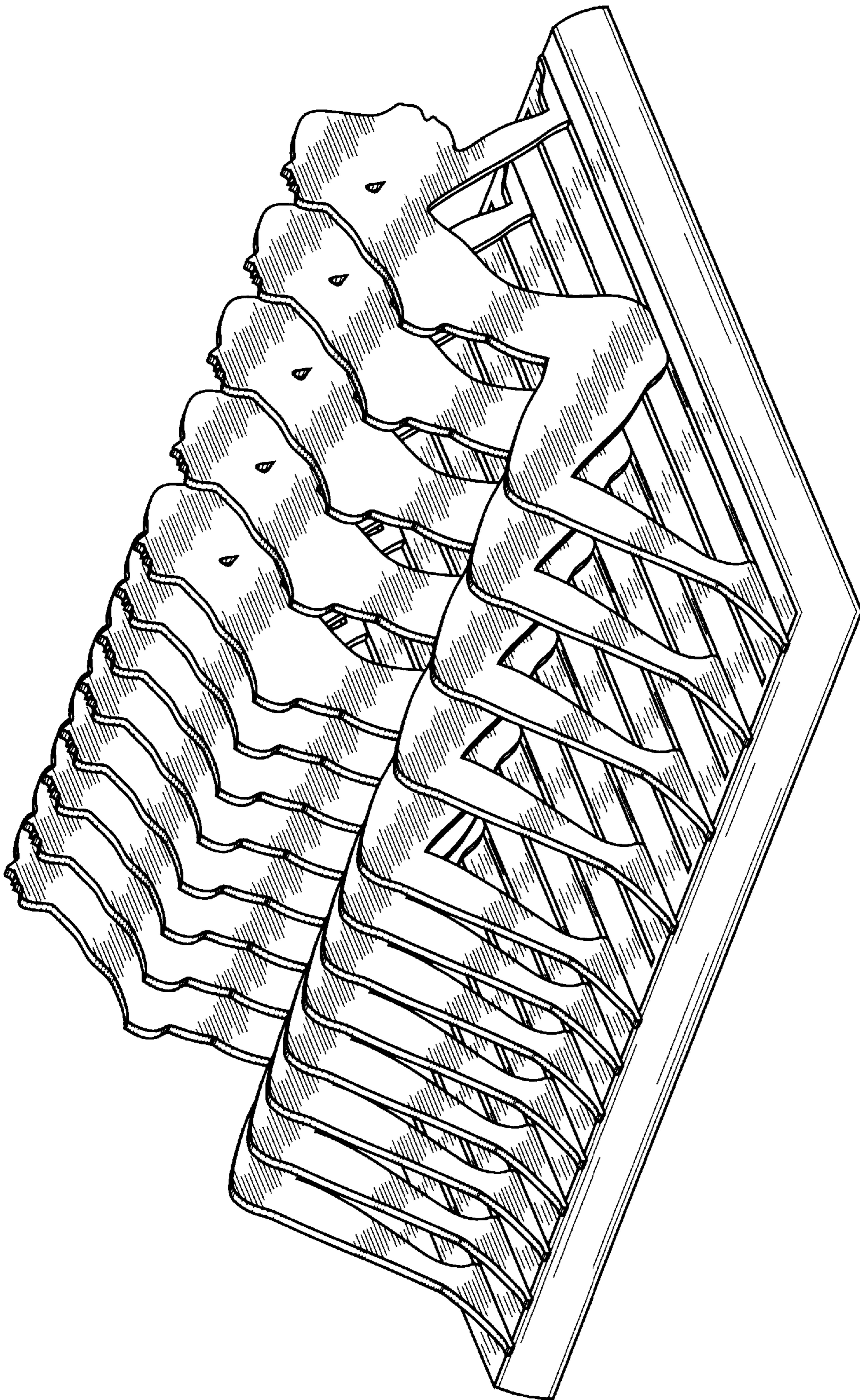

FIG. 7

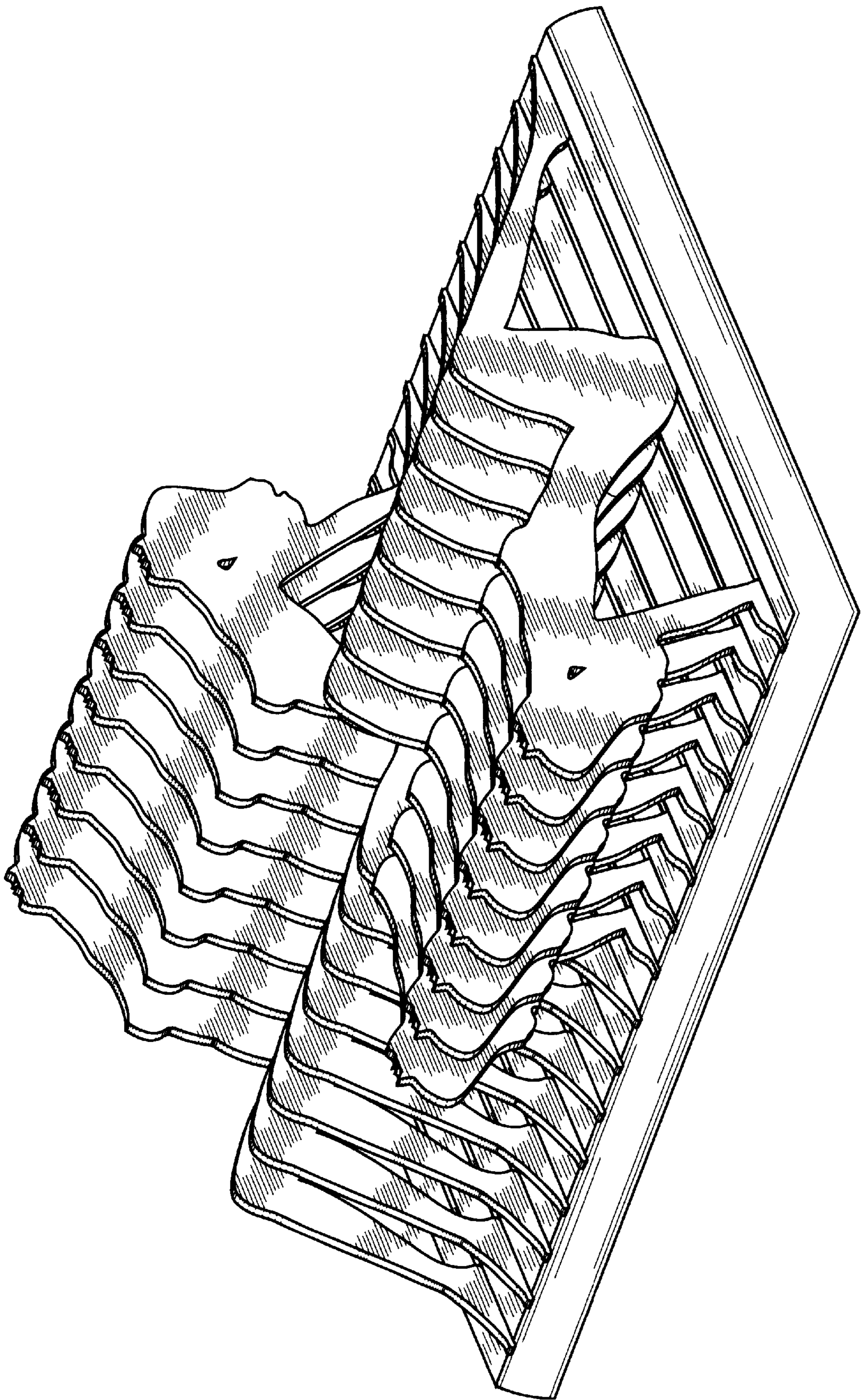

FIG. 8