



US00D436701S

(12) **United States Design Patent**
Salo et al.

(10) **Patent No.:** **US D436,701 S**

(45) **Date of Patent:** **** Jan. 23, 2001**

(54) **FILTER HOLDER FOR A VACUUM CLEANER**

D. 413,698 * 9/1999 Dyson D32/22
D. 417,533 * 12/1999 Burchard et al. D32/22
5,558,697 9/1996 Dyson et al. .

(75) Inventors: **Robert A. Salo; Charles J. Thur**, both of Mentor; **Jeffrey M. Kalman**, Cleveland Heights; **Craig M. Saunders**, Rocky River; **Cynthia M. Caffoe**, Cleveland Heights, all of OH (US)

* cited by examiner

Primary Examiner—Mitchell Siegel

(74) *Attorney, Agent, or Firm*—Fay, Sharpe, Fagan, Minnich & McKee, LLP

(73) Assignee: **Royal Appliance Mfg. Co.**, Cleveland, OH (US)

(57) **CLAIM**

The ornamental design for a filter holder for a vacuum cleaner, as shown and described.

(**) Term: **14 Years**

DESCRIPTION

(21) Appl. No.: **29/116,865**

FIG. 1 is a perspective view of a filter holder for a vacuum cleaner showing our new design;
FIG. 2 is a front elevational view thereof;
FIG. 3 is a right side elevational view thereof;
FIG. 4 is a rear elevational view thereof;
FIG. 5 is a left side elevational view thereof;
FIG. 6 is a top plan view thereof; and,
FIG. 7 is a bottom plan view thereof.

(22) Filed: **Jan. 12, 2000**

(51) **LOC (7) Cl.** **15-05**

(52) **U.S. Cl.** **D32/25**

(58) **Field of Search** D32/25, 30, 22;
15/320, 322, 323, 347, 350–353, 410, 412

The vacuum cleaner portions illustrated in broken lines in the Figures show the environment in which the filter holder for a vacuum cleaner according to the present invention is used and form no part of the claimed design.

(56) **References Cited**

U.S. PATENT DOCUMENTS

- D. 343,707 1/1994 Dyson .
- D. 365,669 * 12/1995 Piccaluga et al. D32/22
- D. 375,820 11/1996 Piccaluga et al. .

1 Claim, 4 Drawing Sheets

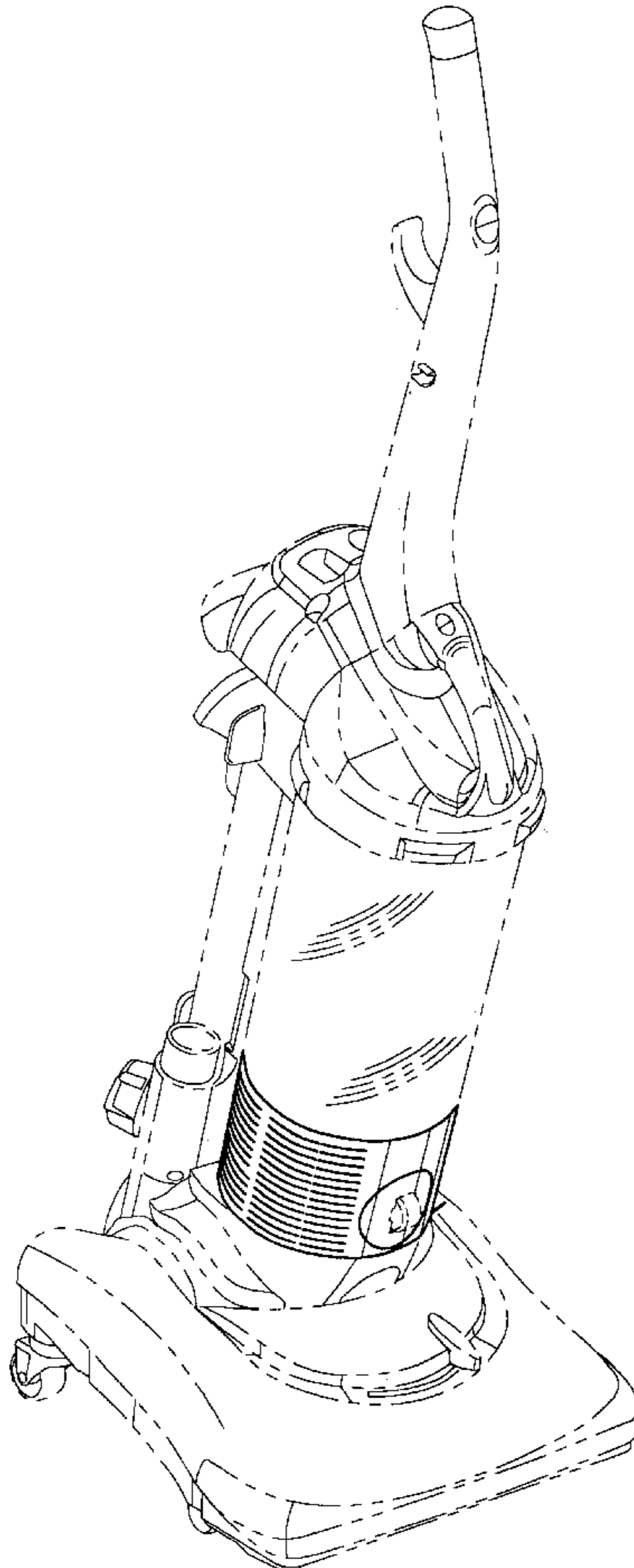
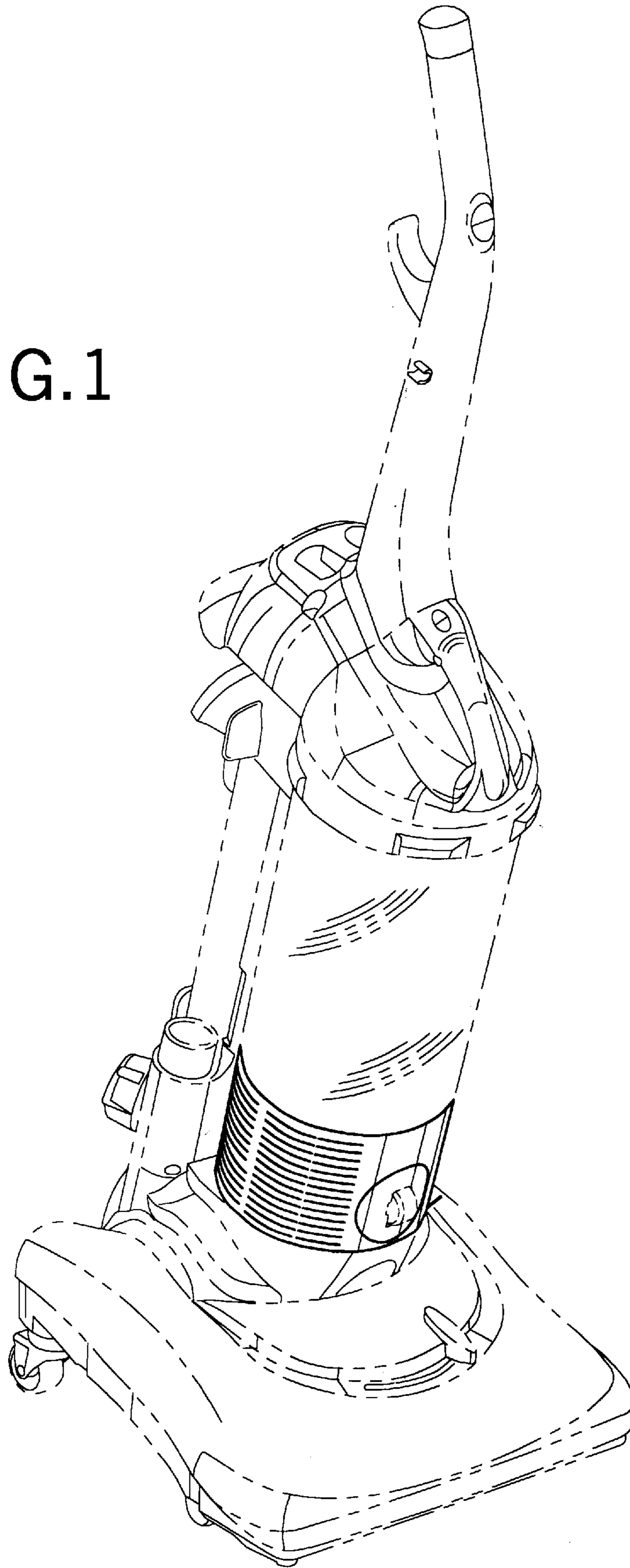

FIG. 1



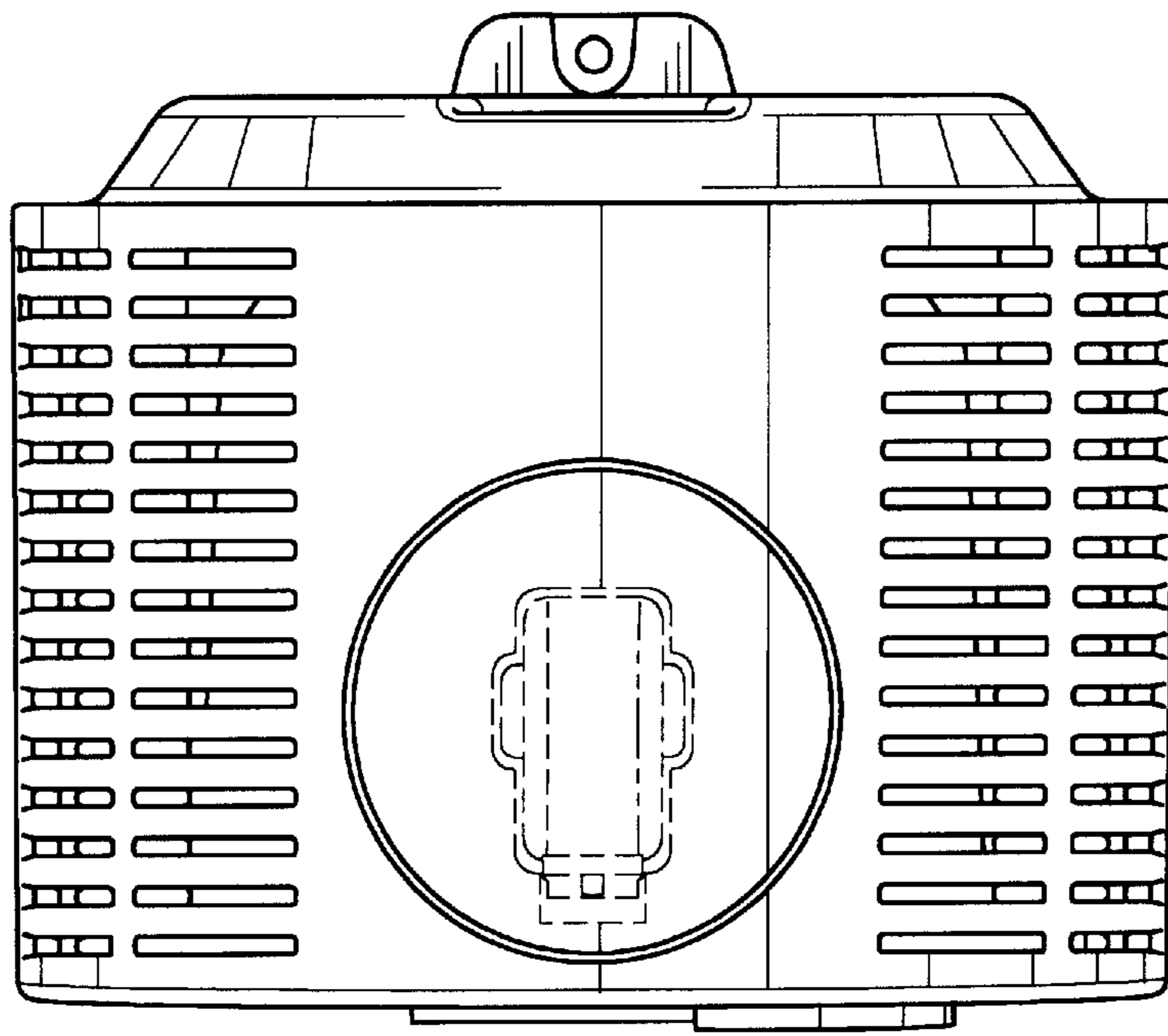

FIG. 2

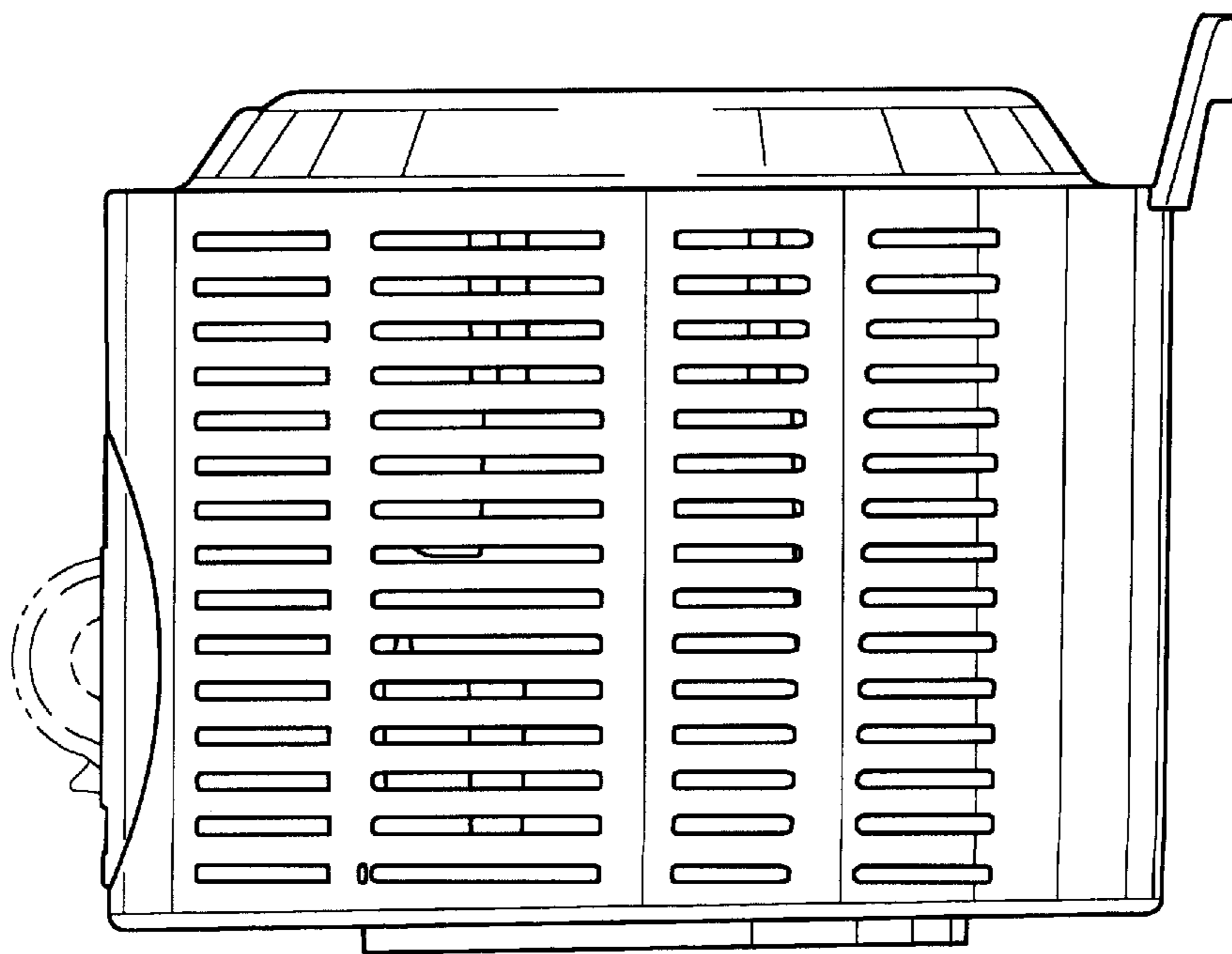

FIG. 3

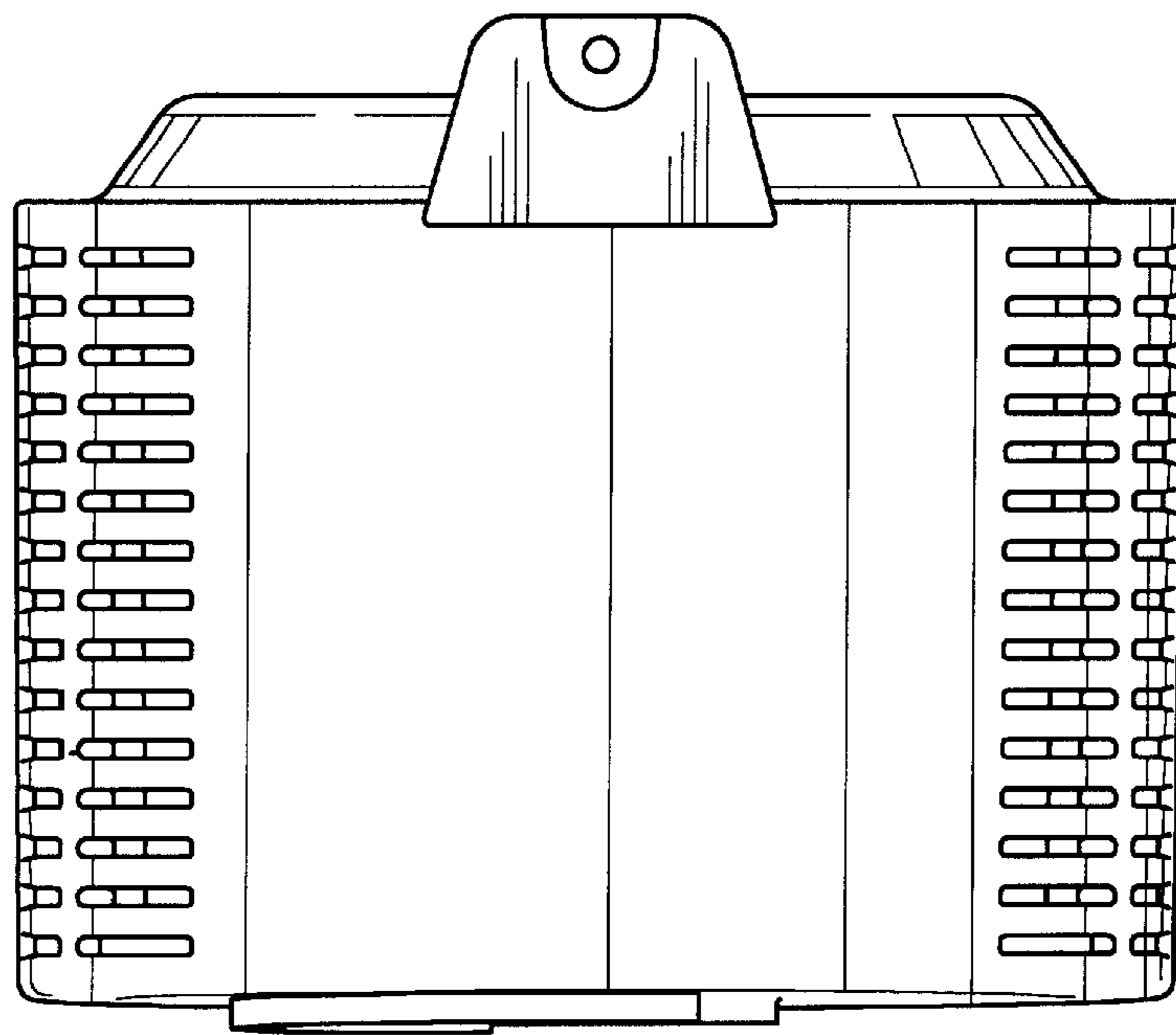

FIG. 4

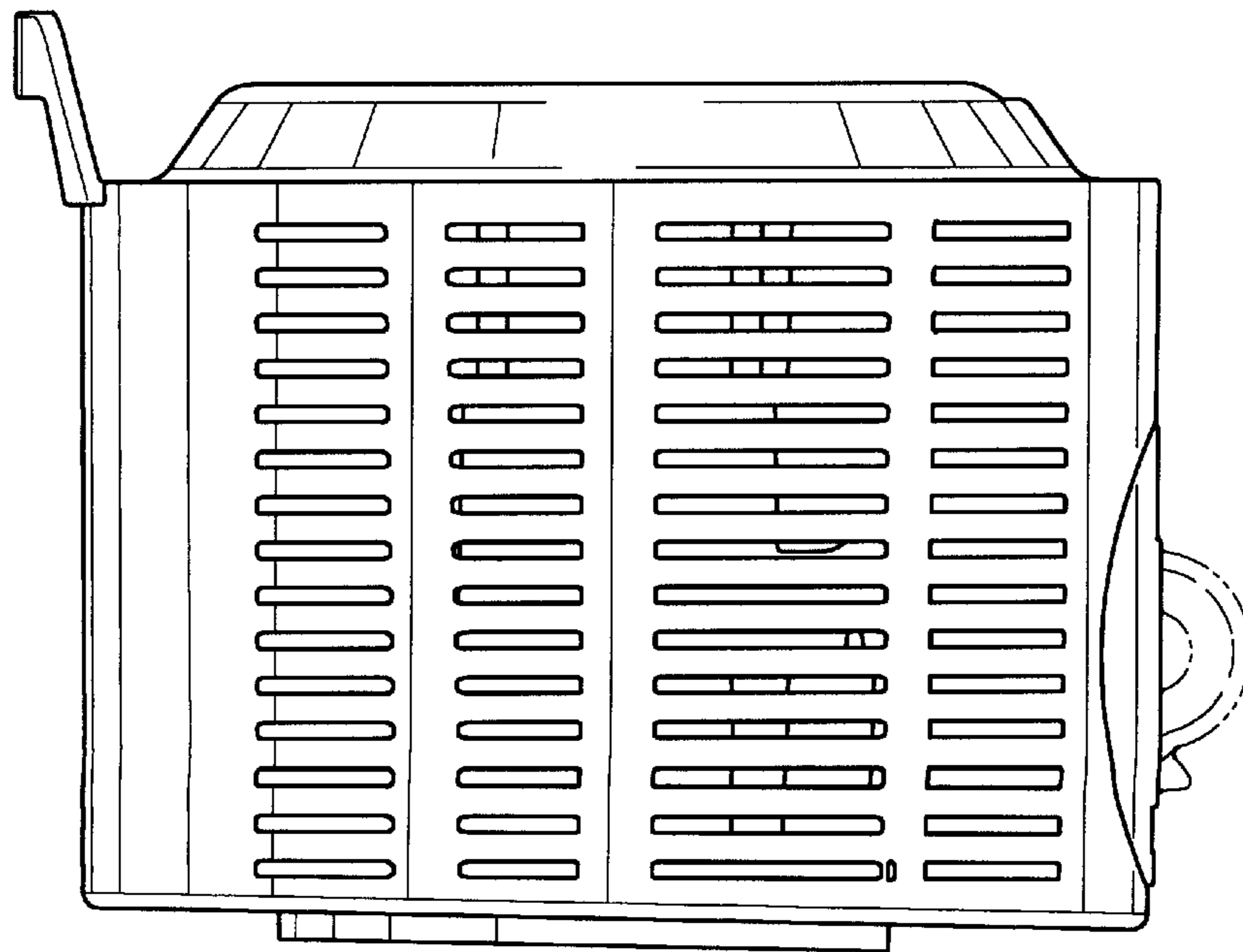

FIG. 5

FIG.6

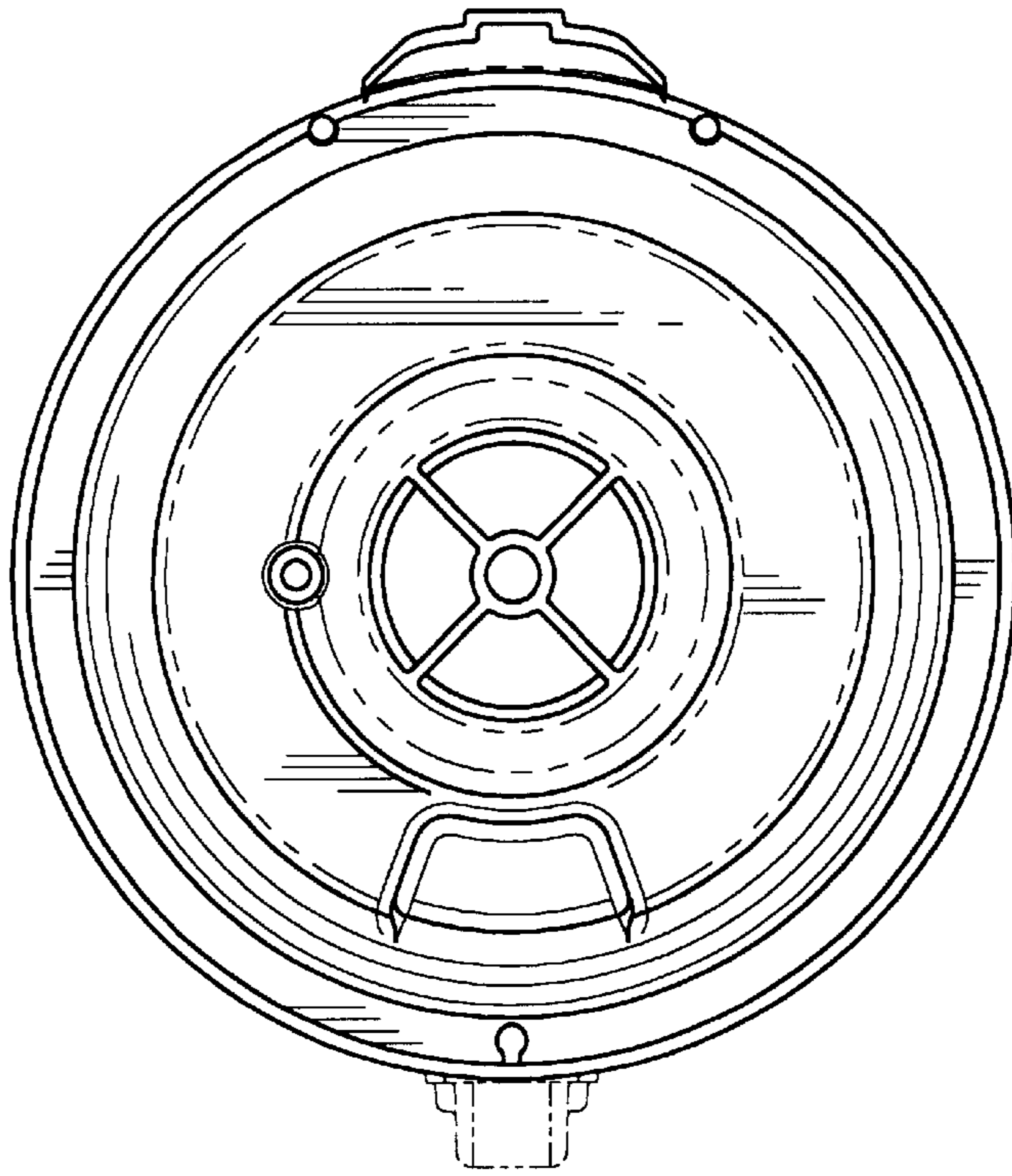

FIG.7

