



US00D436618S

(12) **United States Design Patent**  
**Kotaki et al.**

(10) **Patent No.:** **US D436,618 S**

(45) **Date of Patent:** **\*\* Jan. 23, 2001**

(54) **INK TANK FOR PRINTER**

(75) Inventors: **Yasuo Kotaki**, Yokohama; **Masashi Ogawa**, Kawasaki; **Tsutomu Abe**, Atsugi; **Hitomi Ito**, Tokyo, all of (JP)

(73) Assignee: **Canon Kabushiki Kaisha**, Tokyo (JP)

(\*\*) Term: **14 Years**

(21) Appl. No.: **29/116,668**

(22) Filed: **Jan. 10, 2000**

(30) **Foreign Application Priority Data**

Jul. 14, 1999 (JP) ..... 11-18828

(51) **LOC (7) Cl.** ..... **18-02**

(52) **U.S. Cl.** ..... **D18/56; 347/86**

(58) **Field of Search** ..... **D18/56; 347/86, 347/87**

(56) **References Cited**

**U.S. PATENT DOCUMENTS**

- D. 367,884 \* 3/1996 Taneya et al. .... D18/56
- D. 372,045 \* 7/1996 Tokuda et al. .... D18/56
- D. 376,385 \* 12/1996 Tashiro et al. .... D18/56
- D. 378,833 \* 4/1997 Tashiro et al. .... D18/56
- D. 383,157 \* 9/1997 Tashiro et al. .... D18/56

- D. 390,868 \* 2/1998 Tashiro et al. .... D18/56
- D. 392,670 \* 3/1998 Tashiro et al. .... D18/56
- D. 395,446 \* 6/1998 Tashiro et al. .... D18/56
- D. 401,620 \* 11/1998 Nozawa et al. .... D18/56
- D. 401,621 \* 11/1998 Shimizu et al. .... D18/56
- 5,619,237 \* 4/1997 Inoue et al. .... 347/86
- 5,831,652 \* 11/1998 Hinami et al. .... 347/86

\* cited by examiner

*Primary Examiner*—Cathy Anne MacCormac

(74) *Attorney, Agent, or Firm*—Fitzpatrick, Cella, Harper & Scinto

(57) **CLAIM**

The ornamental design for an ink tank for printer, as shown and described.

**DESCRIPTION**

FIG. 1 is a front view of an ink tank for printer showing our new design;

FIG. 2 is a rear view thereof;

FIG. 3 is a top plan view thereof;

FIG. 4 is a bottom plan view thereof;

FIG. 5 is a left side view thereof;

FIG. 6 is a right side view thereof; and,

FIG. 7 is a perspective view thereof.

**1 Claim, 4 Drawing Sheets**

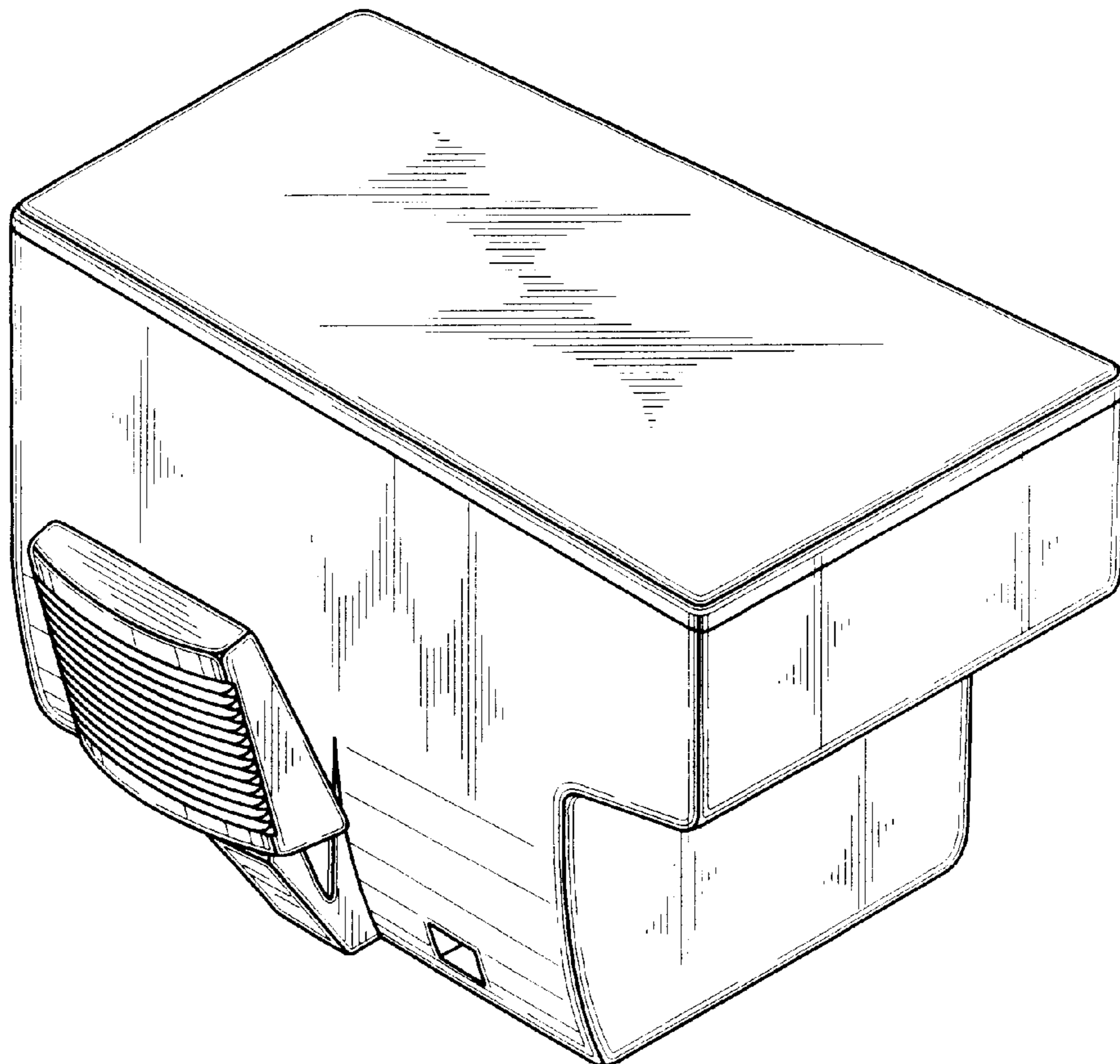

*FIG. 1*

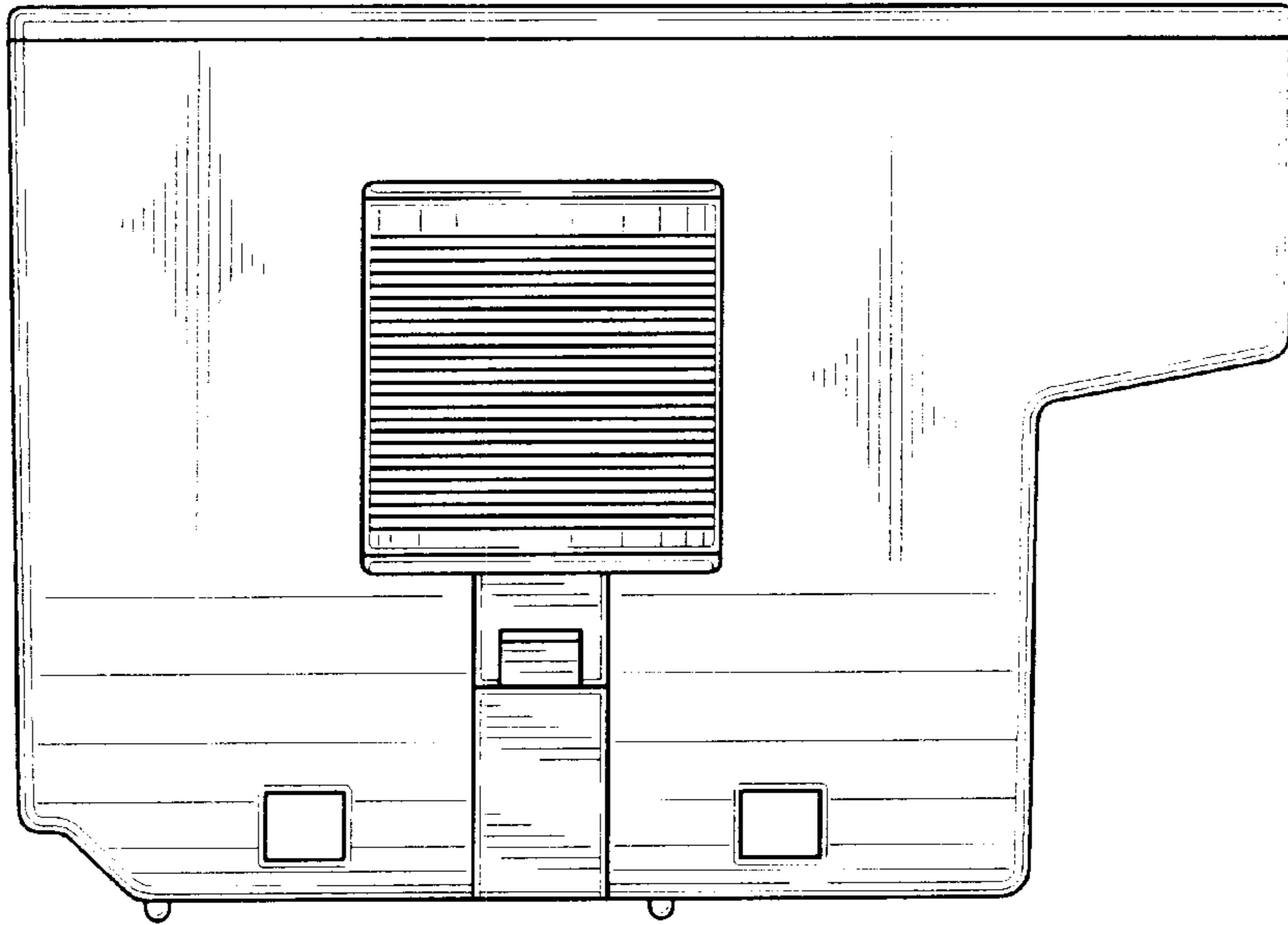

*FIG. 2*

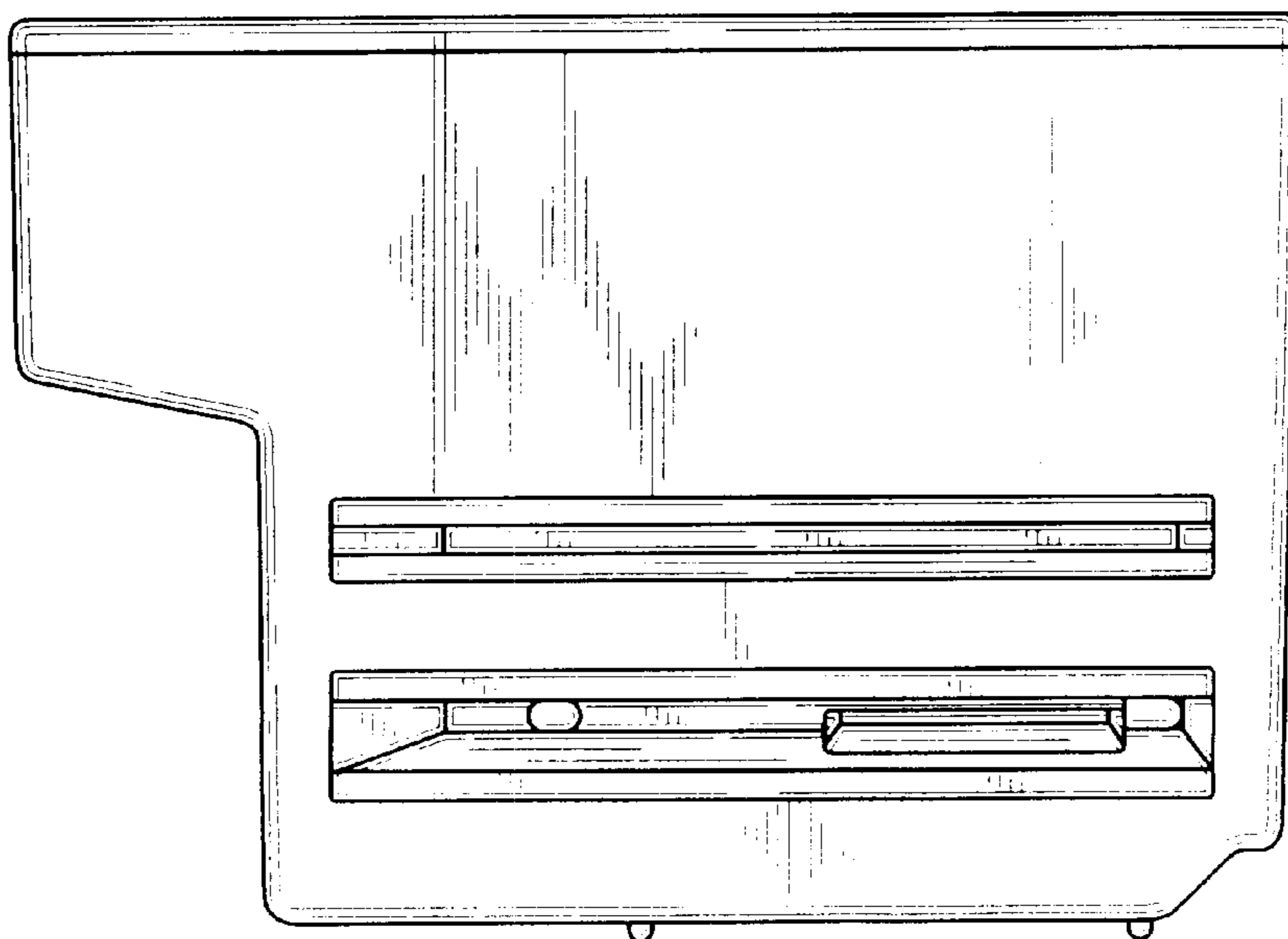

*FIG. 3*

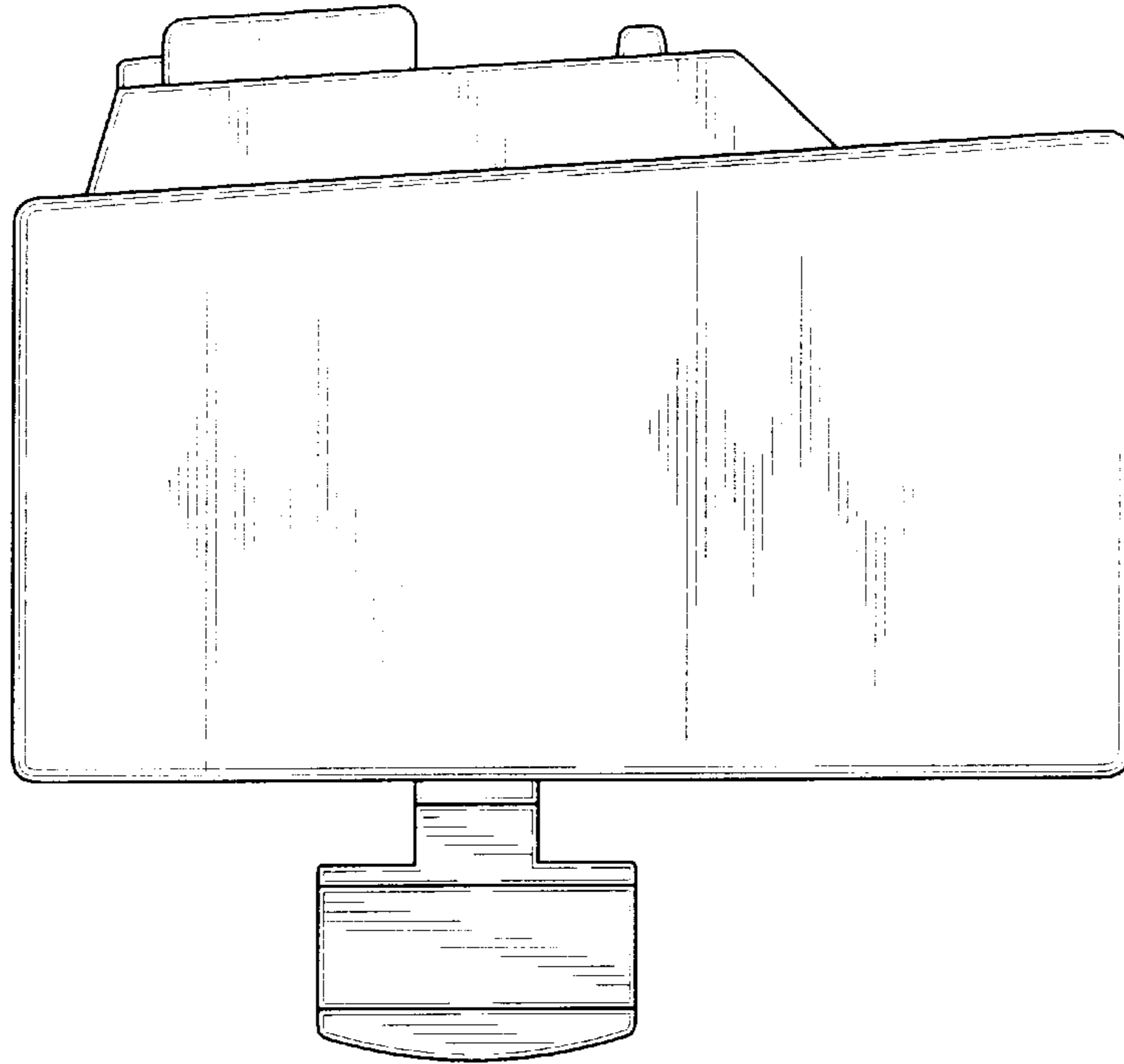

*FIG. 4*

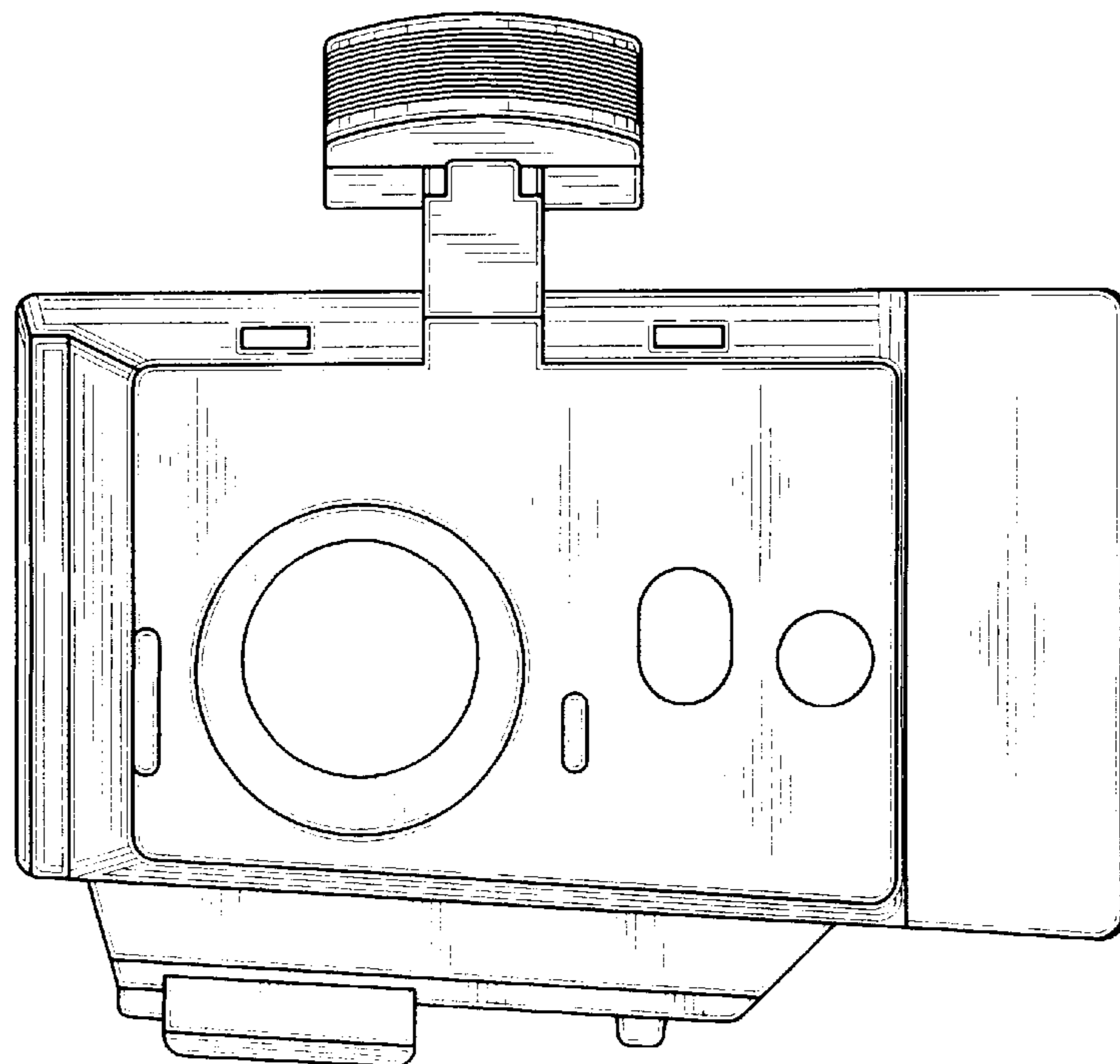

*FIG. 5*

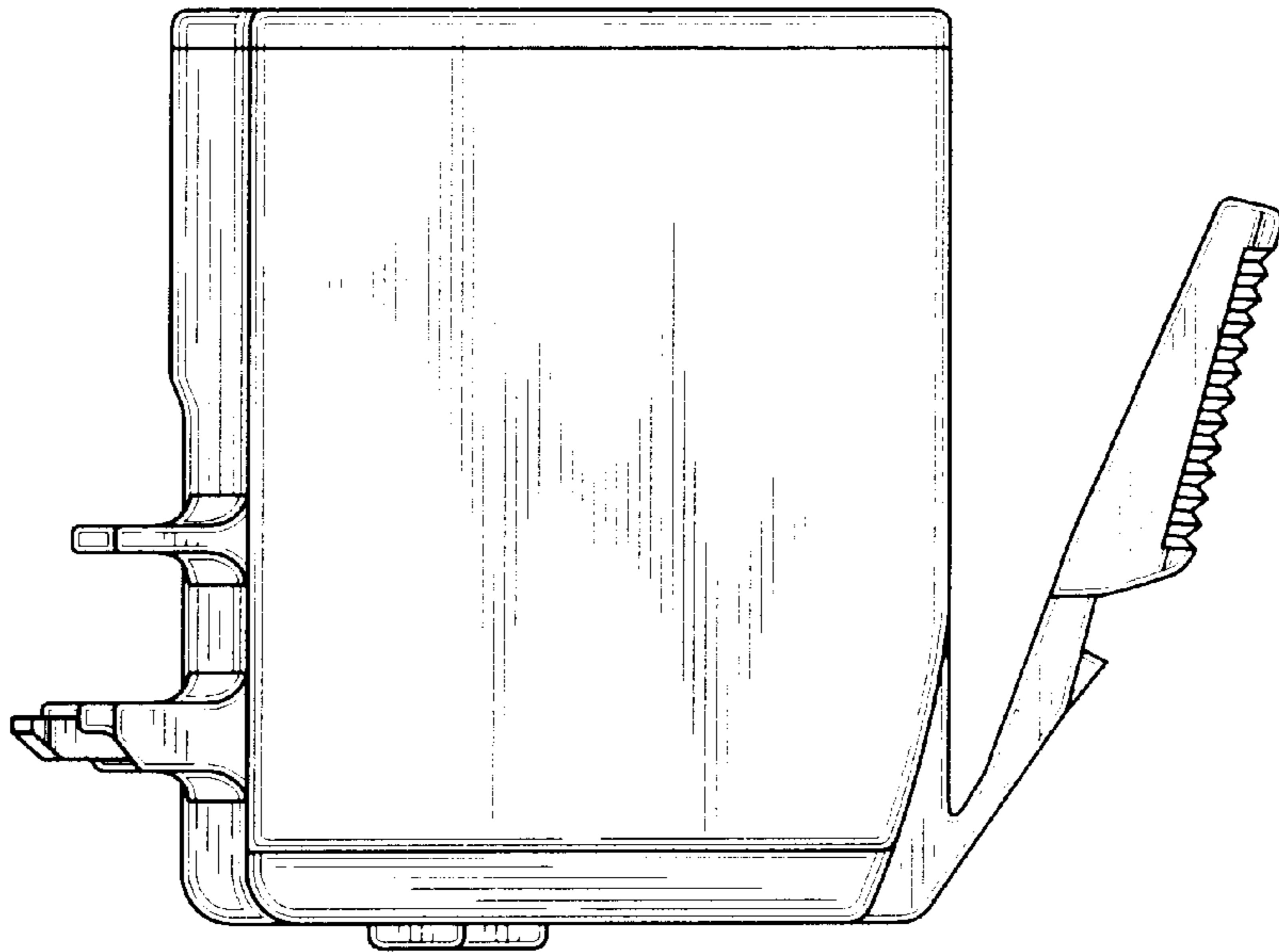

*FIG. 6*

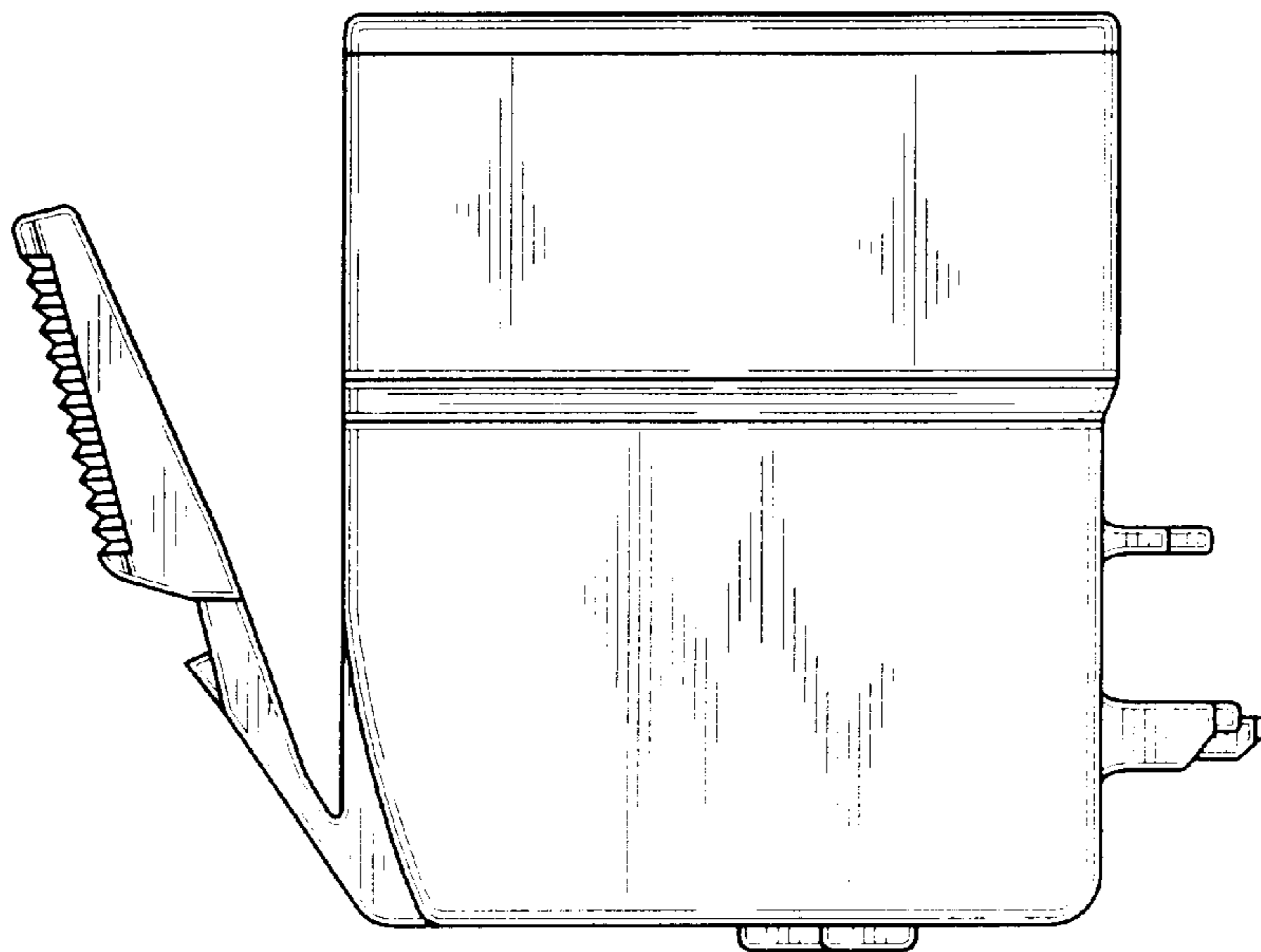

*FIG. 7*

