



US00D436531S

(12) **United States Design Patent**
Holmes et al.

(10) **Patent No.:** **US D436,531 S**

(45) **Date of Patent:** **** Jan. 23, 2001**

(54) **PRODUCT PACKAGE**

3,240,384 * 3/1966 Lerner 206/806 X
5,740,911 * 4/1998 Chou 206/806

(75) Inventors: **Joan Catherine Holmes**, Framingham;
Steven Bingham Smith, Needham,
both of MA (US)

OTHER PUBLICATIONS

Techform Inc. (From 206/461 Shoe) Nov. 1982.*

(73) Assignee: **Polaroid Corporation**, Cambridge, MA
(US)

* cited by examiner

(**) Term: **14 Years**

Primary Examiner—Prabhakar Deshmukh

(74) *Attorney, Agent, or Firm*—Leslie Payne

(21) Appl. No.: **29/124,811**

(57) **CLAIM**

(22) Filed: **Jun. 12, 2000**

The ornamental design for a product package, as described and shown.

(51) **LOC (7) Cl.** **09-03**

DESCRIPTION

(52) **U.S. Cl.** **D9/418; D9/415**

(58) **Field of Search** D9/414, 415, 418,
D9/428, 429, 337; 206/461-471, 806, 495,
775-783; 229/162, 4.5, 5.5; 220/675, 662

FIG. 1 is a right front perspective view of a product package showing our new design;

FIG. 2 is a front elevation view thereof;

FIG. 3 is a right side elevation view thereof;

FIG. 4 is a top plan view thereof;

FIG. 5 is a rear elevational view thereof;

FIG. 6 is a left side elevation view thereof; and,

FIG. 7 is a bottom view thereof.

The broken line showing of the inside product is for illustrative purpose only and forms no part of the claimed design.

(56) **References Cited**

U.S. PATENT DOCUMENTS

- D. 313,753 * 1/1991 Nagasaka D9/415
- D. 315,095 * 3/1991 Wright D9/418 X
- D. 389,401 * 1/1998 Holley, Jr. D9/415
- D. 429,638 * 6/2000 Li et al. D9/418 X
- 3,023,925 * 3/1962 Sher 206/806 X

1 Claim, 3 Drawing Sheets

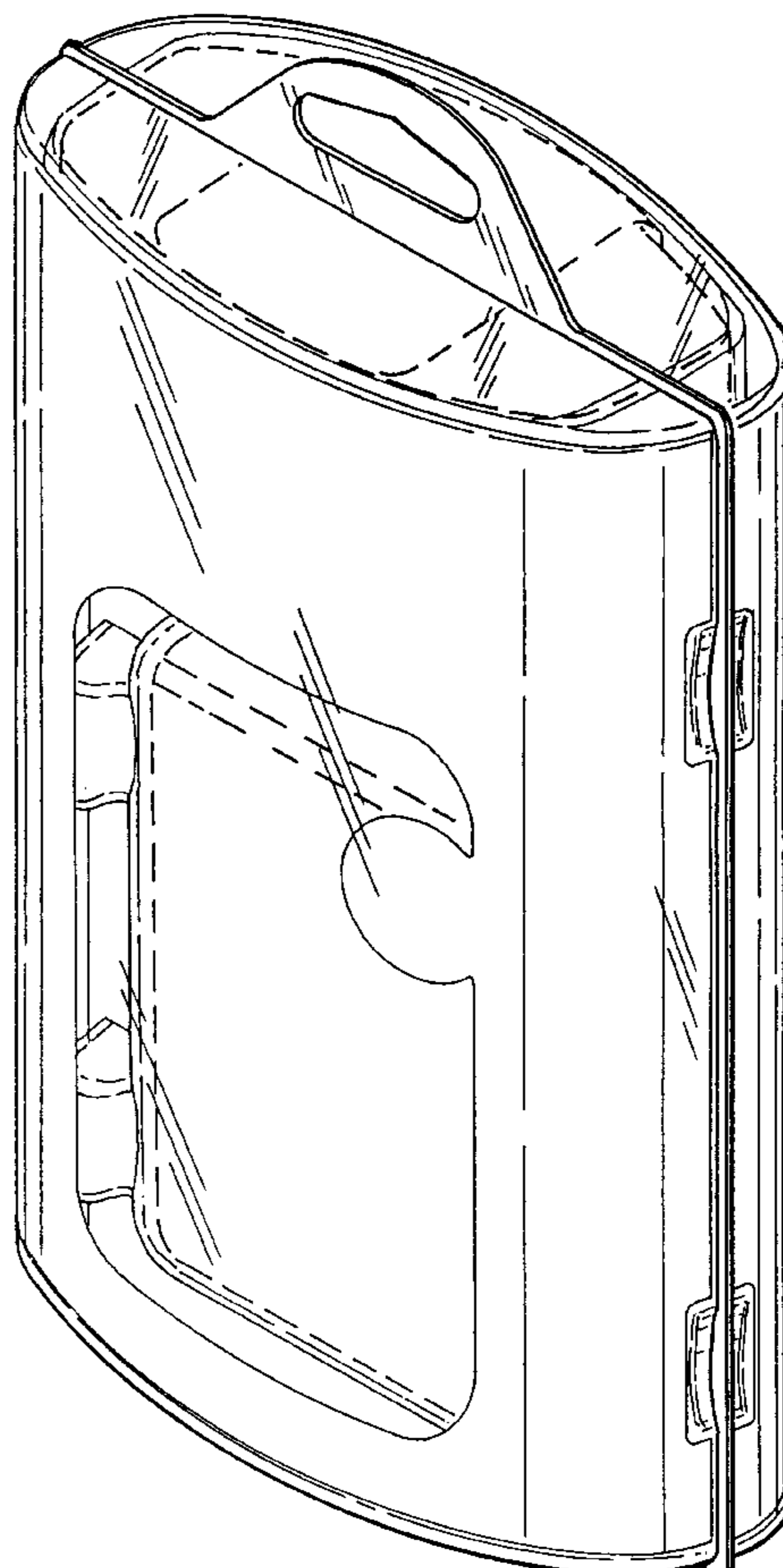

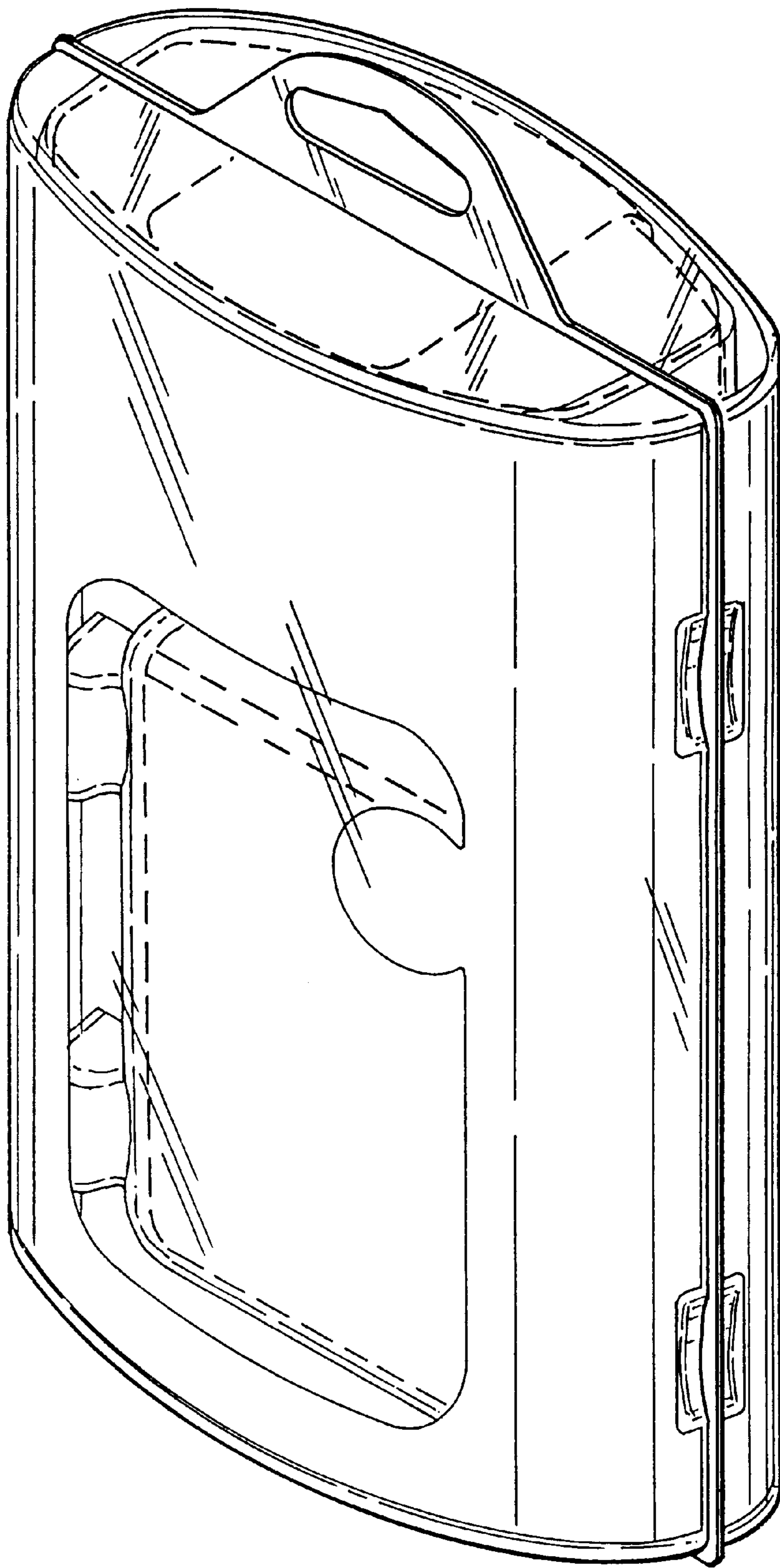

FIG. 1

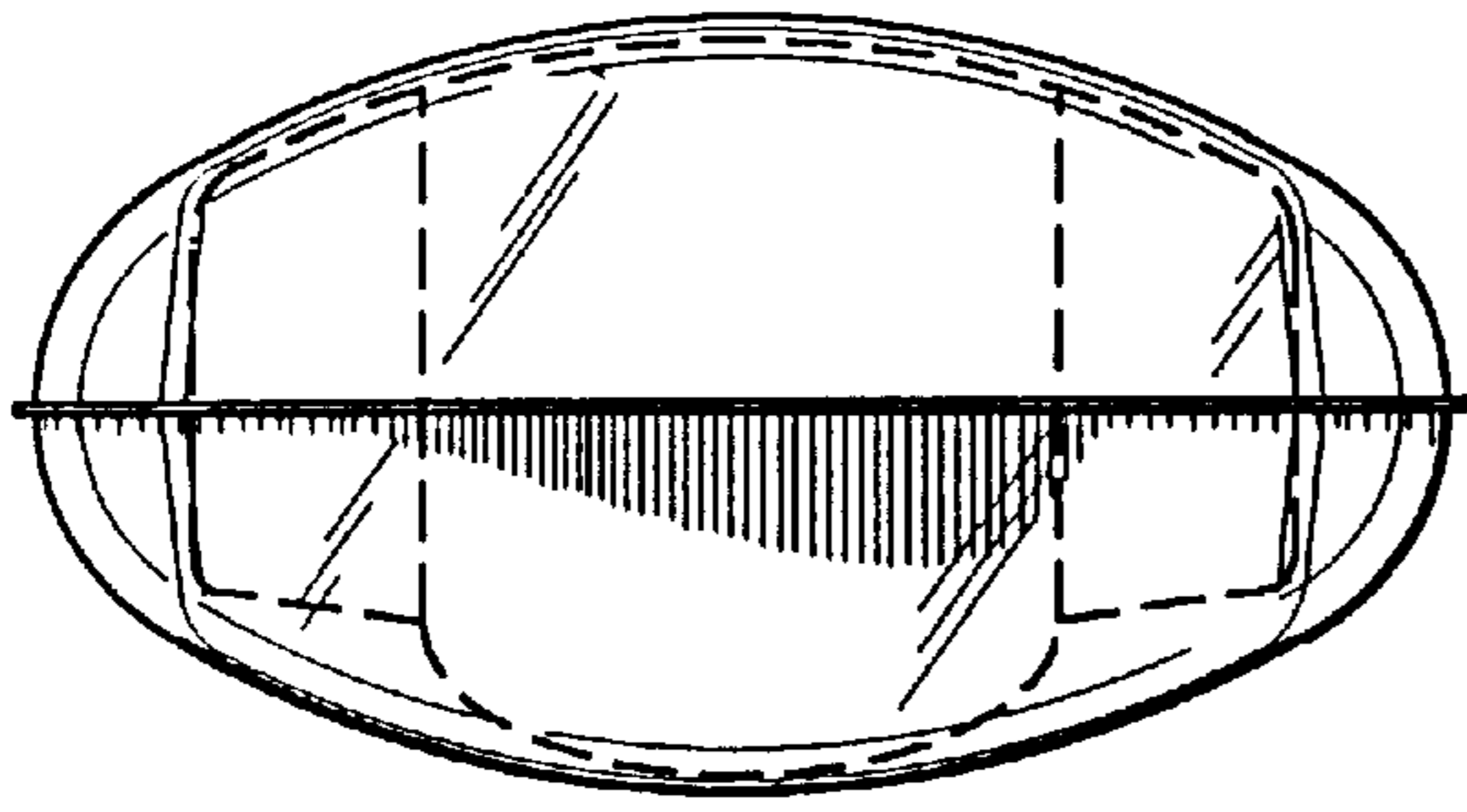

FIG. 4

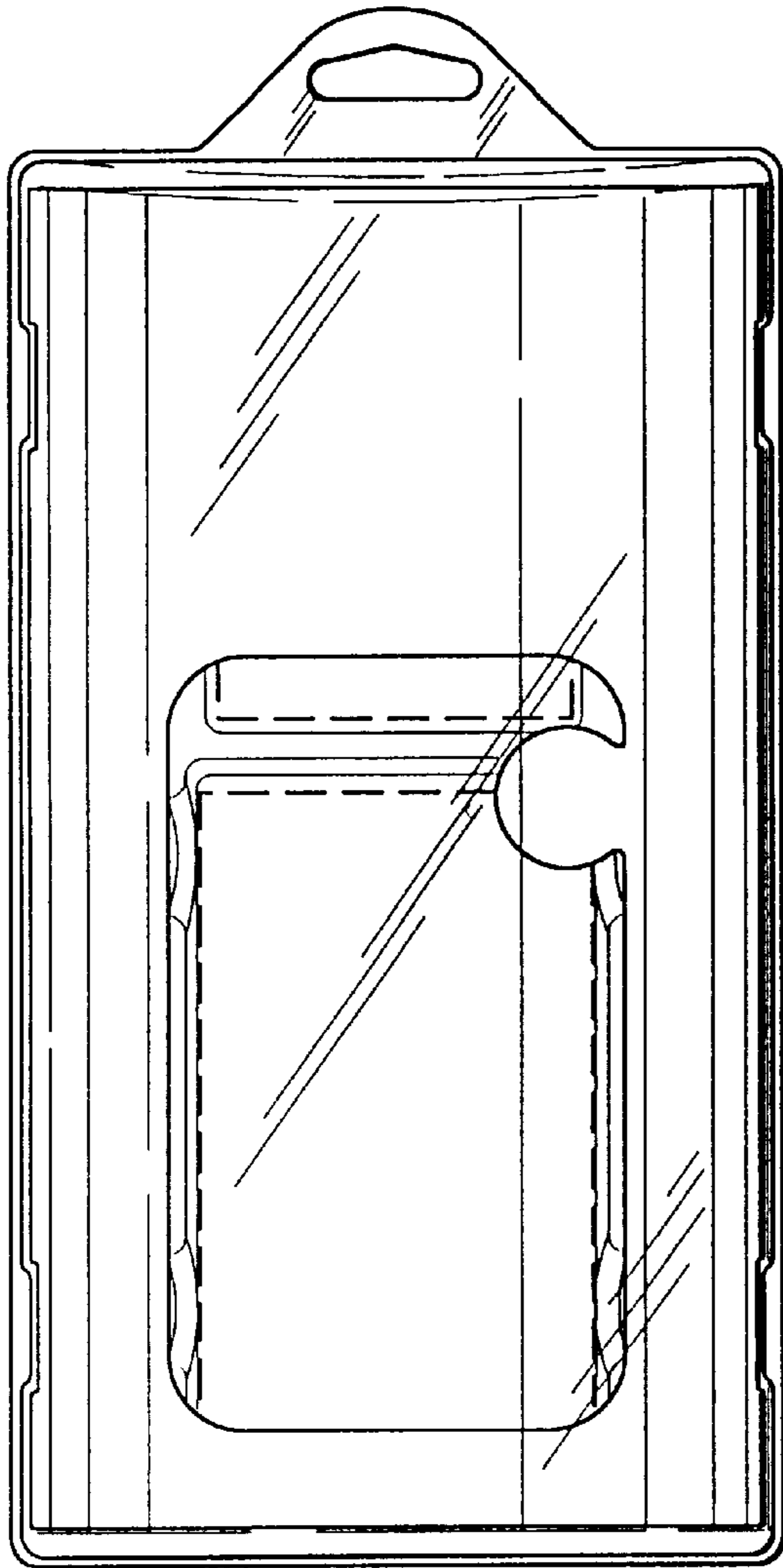

FIG. 2

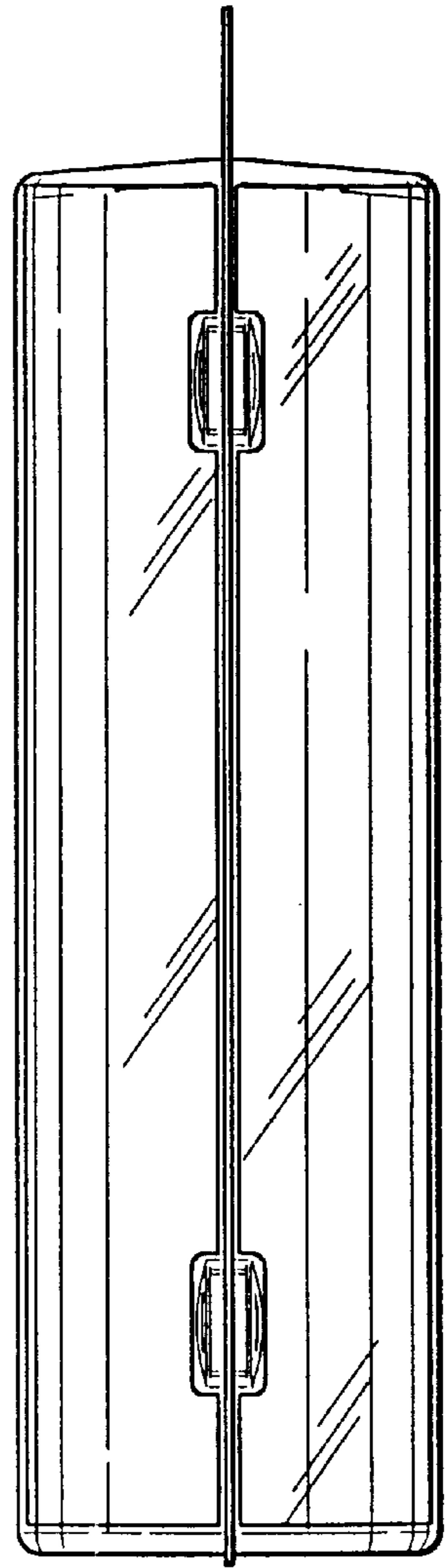

FIG. 3

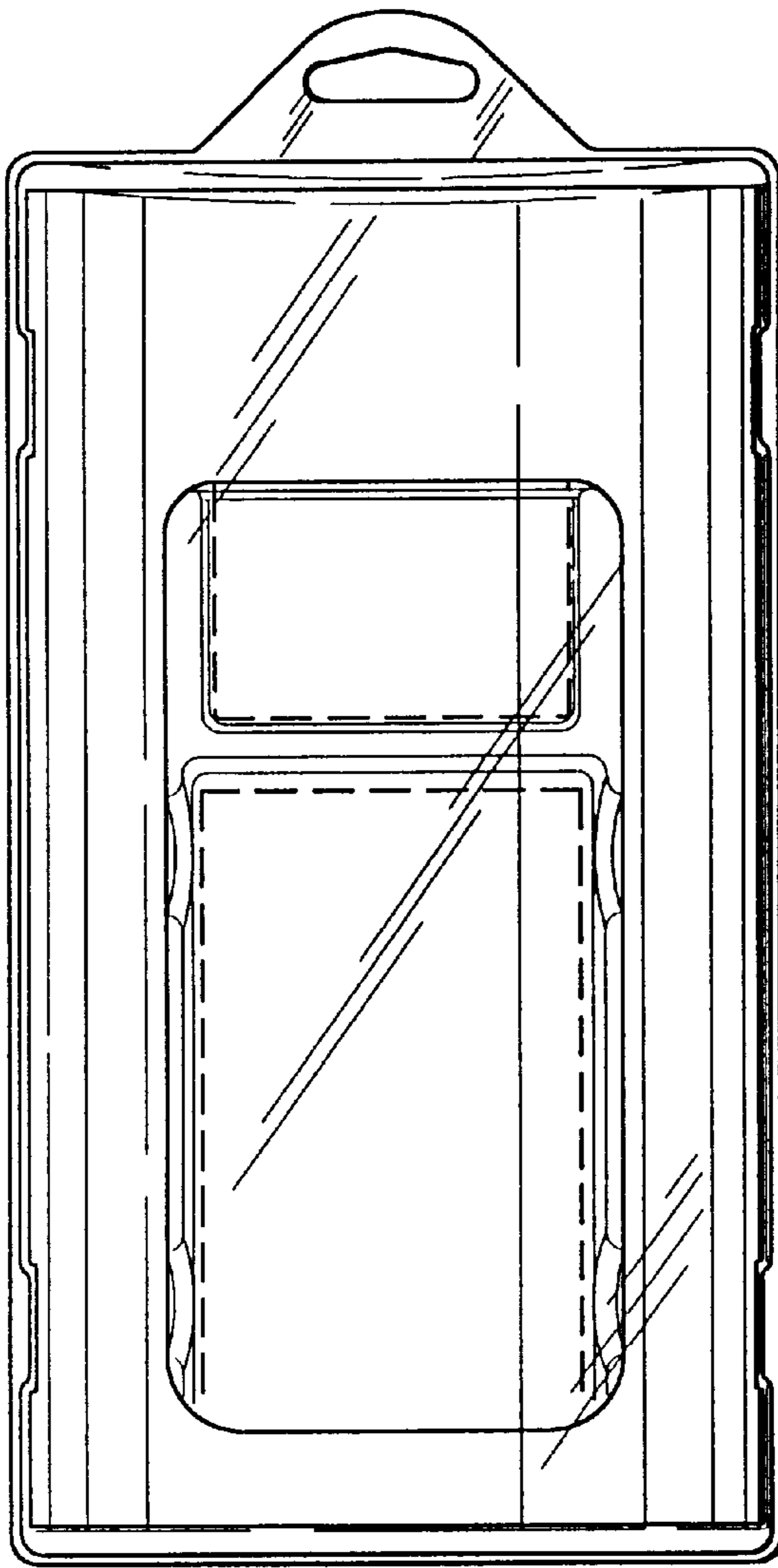

FIG. 5

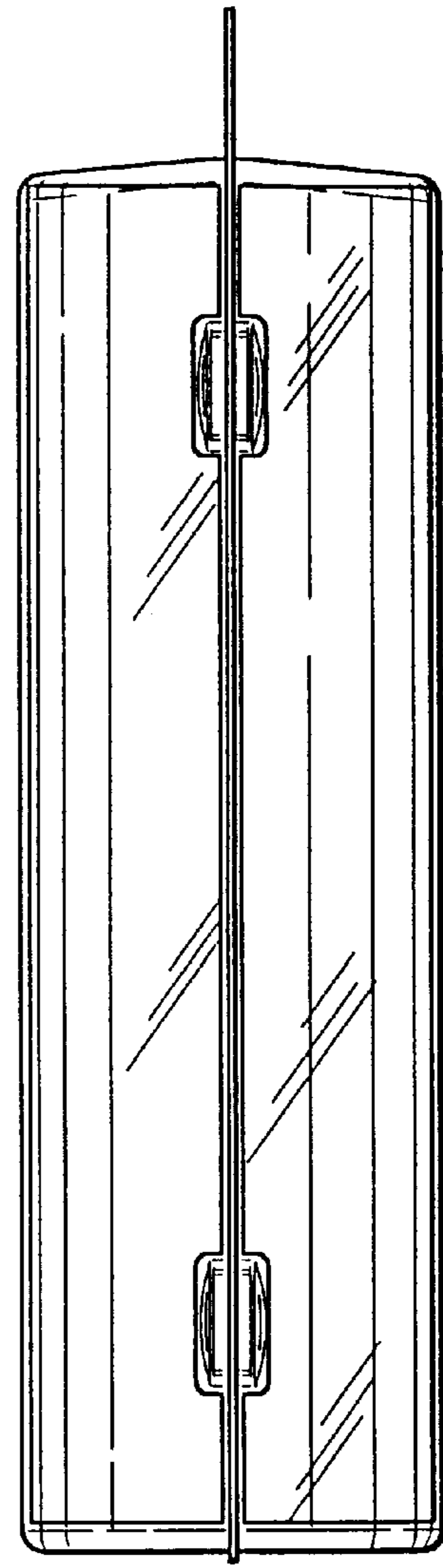

FIG. 6

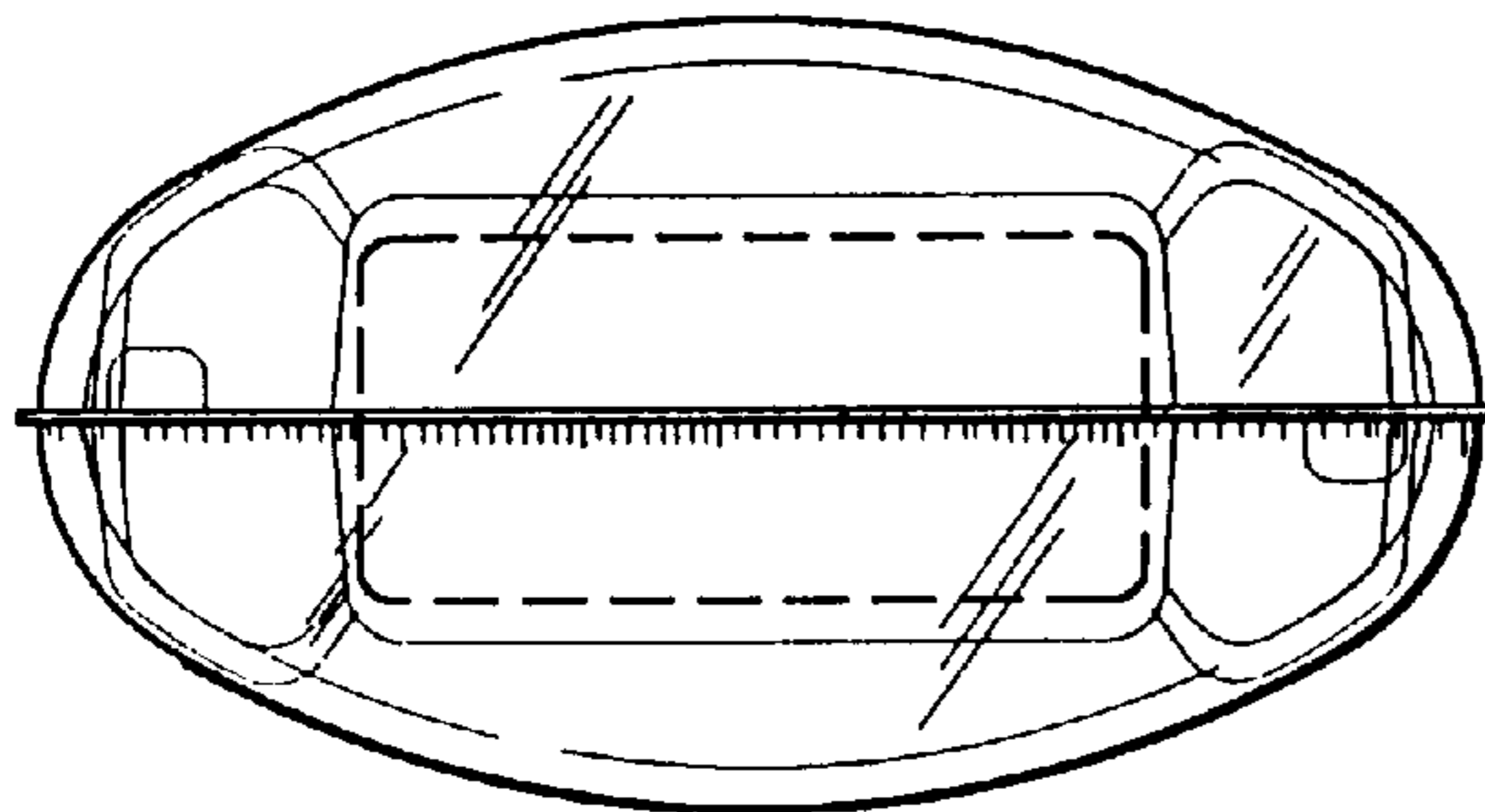

FIG. 7