



US00D436507S

(12) **United States Design Patent**
Cheng

(10) **Patent No.:** **US D436,507 S**

(45) **Date of Patent:** **** Jan. 23, 2001**

(54) **HOT AIR BLOWER**

(76) **Inventor:** **Chuan-Hsin Cheng,**
5F,No.637-1,Sec.5,Chung-Hsin Road,
San-Chung City, Taipei Hsien (TW)

(**) **Term:** **14 Years**

(21) **Appl. No.:** **29/121,470**

(22) **Filed:** **Apr. 5, 2000**

(51) **LOC (7) Cl.** **08-05**

(52) **U.S. Cl.** **D8/29.1**

(58) **Field of Search** D8/29.1, 29.2,
D8/30, 61; 392/384, 385, 383, 369; 219/222,
228, 221, 227

(56) **References Cited**

U.S. PATENT DOCUMENTS

- D. 280,338 * 8/1985 Skarsten D8/29.1
- D. 297,397 * 8/1988 Pagani D8/29.1
- D. 319,768 * 9/1991 Smith D8/29.1
- D. 322,742 * 12/1991 Spratt D8/29.1

- D. 334,876 * 4/1993 Swetish D8/29.1
- D. 388,297 * 12/1997 Bittenbender D8/29.1
- D. 388,298 * 12/1997 Jerdee et al. D8/29.1

* cited by examiner

Primary Examiner—Philip S. Hyder
(74) *Attorney, Agent, or Firm*—Pro-Techtor International
Services

(57) **CLAIM**

The ornamental design for a hot air blower, as shown and described.

DESCRIPTION

FIG. 1 is the front elevational view thereof.
FIG. 2 is the rear elevational view thereof.
FIG. 3 is the left side elevational view thereof.
FIG. 4 is the right side elevational view thereof.
FIG. 5 is the top plan view thereof.
FIG. 6 is the bottom plan view thereof; and,
FIG. 7 is a perspective view of a hot air blower according to my new design.

1 Claim, 4 Drawing Sheets

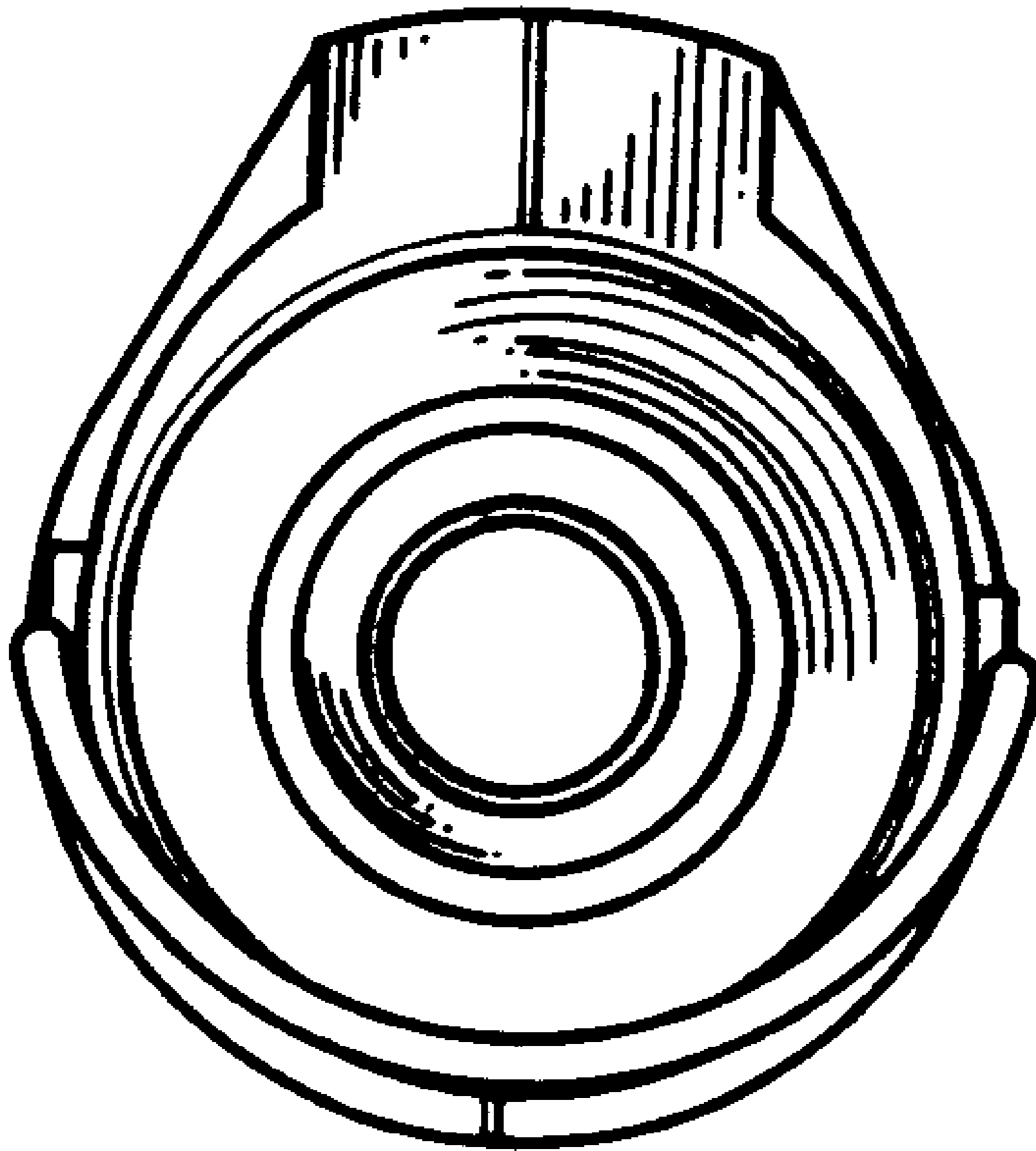

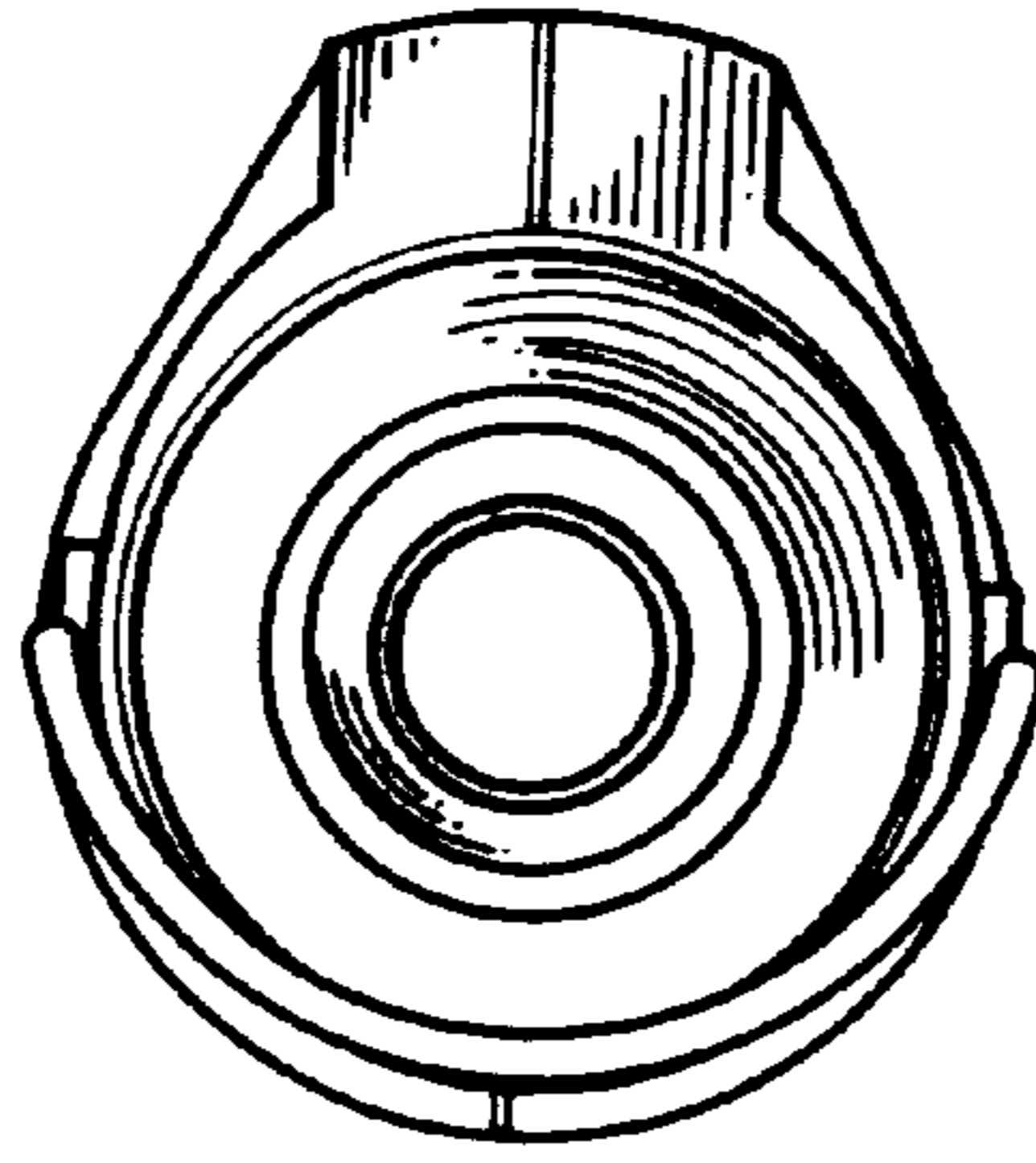

FIG. 1

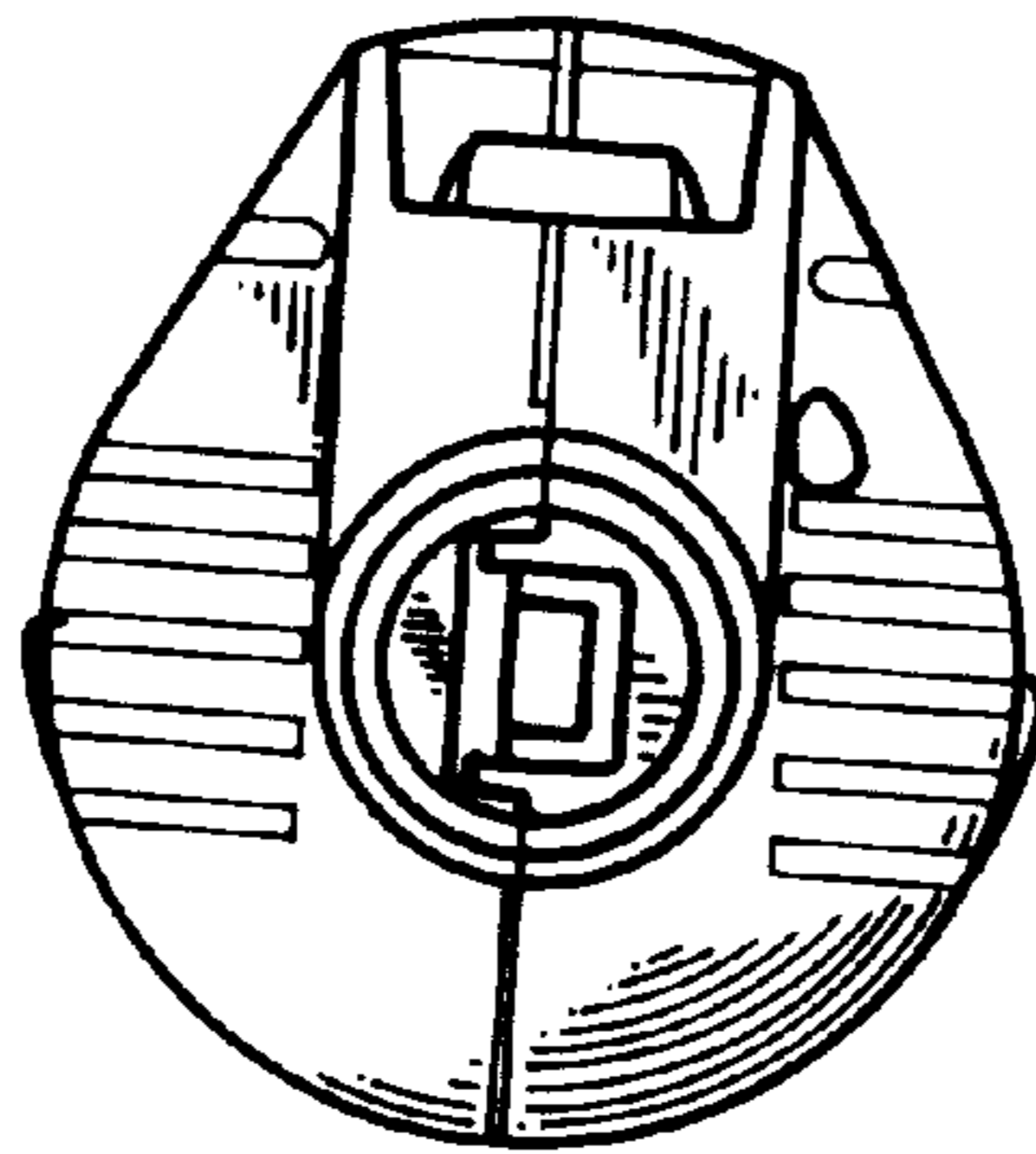

FIG. 2

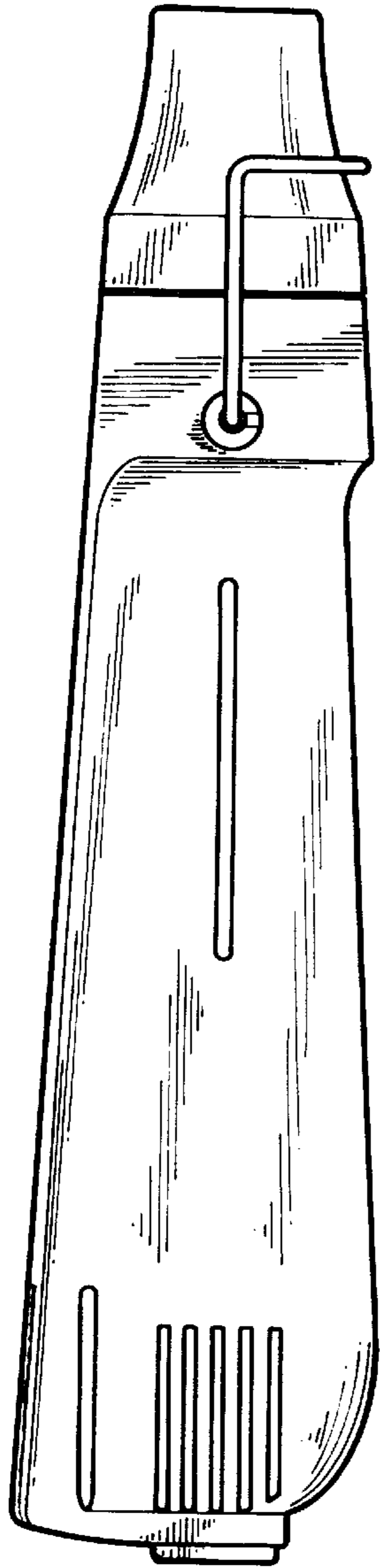

FIG. 3

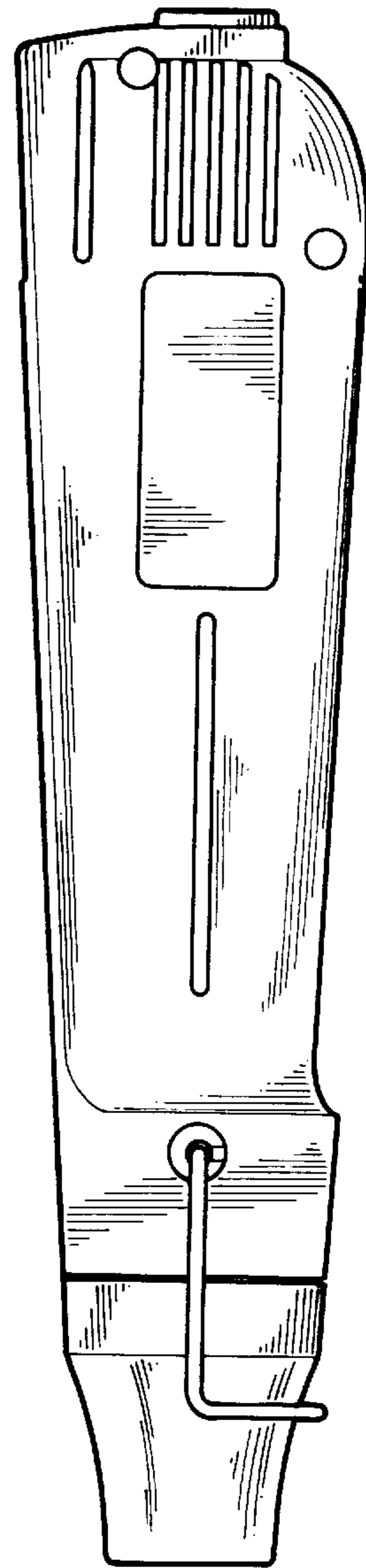

FIG. 4

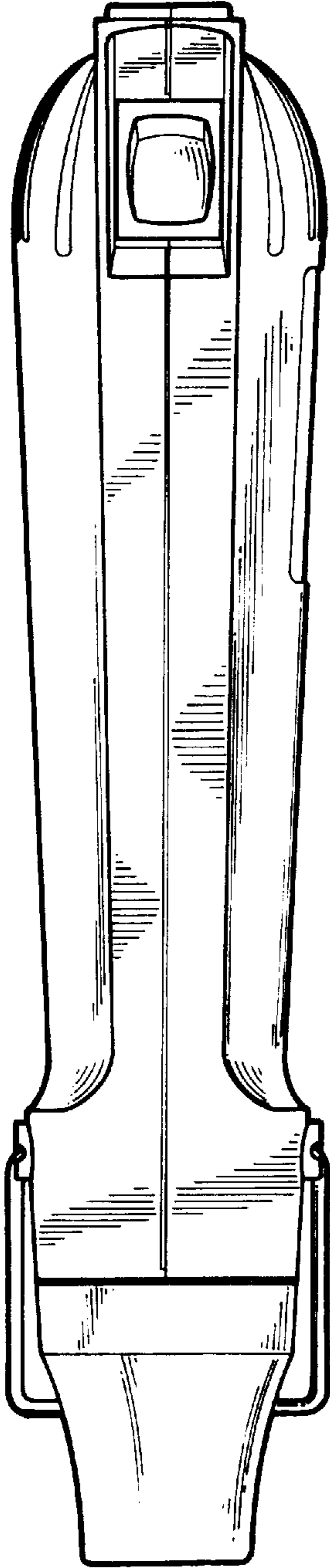

FIG. 5

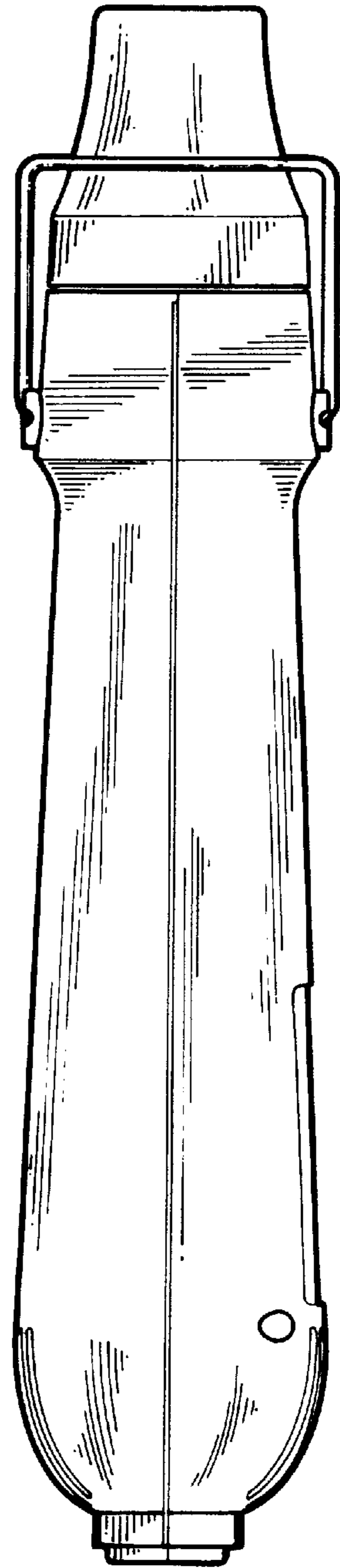

FIG. 6

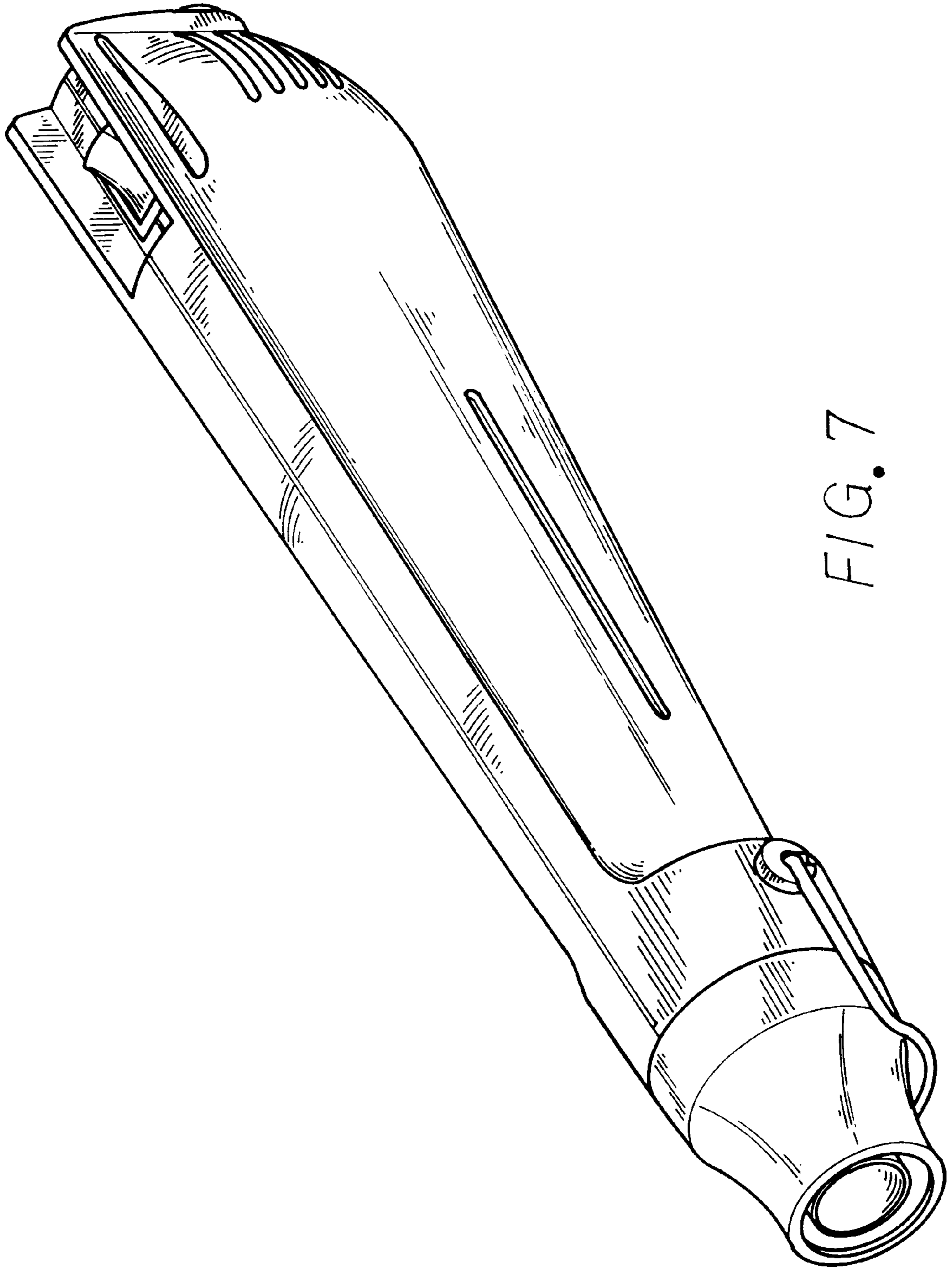

FIG. 7