



US00D436457S

(12) **United States Design Patent**
Ambasz

(10) **Patent No.:** **US D436,457 S**

(45) **Date of Patent:** **** Jan. 23, 2001**

(54) **CHAIR**

(75) Inventor: **Emilio Ambasz**, Buenos Aires (AR)

(73) Assignee: **Vitra Patente AG**, MuttENZ (CH)

(**) Term: **14 Years**

(21) Appl. No.: **29/103,634**

(22) Filed: **Apr. 19, 1999**

(30) **Foreign Application Priority Data**

Oct. 20, 1998 (XH) DM/045 526

(51) **LOC (7) Cl.** **06-01**

(52) **U.S. Cl.** **D6/368**

(58) **Field of Search** D6/334, 335, 368,
D6/370, 374, 376, 379, 380, 500, 501,
502; 297/35, 38, 40, 41, 55, 56, 57, 58,
452.1; 248/164

(56) **References Cited**

U.S. PATENT DOCUMENTS

1,707,769 *	4/1929	Rastetter	297/57
1,740,806 *	12/1929	Clarín	297/56
1,838,212 *	12/1931	Buffington	297/38
1,838,213 *	12/1931	Buffington	297/55
2,701,007 *	2/1955	Hickok	297/40
2,709,482 *	5/1955	Schlaak	297/41

3,025,100 *	3/1962	Morgan	297/41
3,695,687 *	10/1972	Uyeda	297/56
5,524,966 *	6/1996	Piretti	297/55

OTHER PUBLICATIONS

MODEL 2200, relaxed Seating Height (L), MODEL 2250, dining Height (R), p. 15, Samsonite Furniture Co., 1998.*

* cited by examiner

Primary Examiner—Doris V. Coles

Assistant Examiner—Mimosa De

(74) *Attorney, Agent, or Firm*—Selitto & Associates

(57) **CLAIM**

The ornamental design for a chair, as shown.

DESCRIPTION

FIG. 1 is a front perspective view of a chair showing my new design;
FIG. 2 is a front perspective view showing the chair in its closed position;
FIG. 3 is a front elevational view thereof;
FIG. 4 is a rear elevational view thereof;
FIG. 5 is a left side elevational view thereof;
FIG. 6 is a right side elevational view thereof;
FIG. 7 is a top plan view thereof; and,
FIG. 8 is a bottom plan view thereof.

1 Claim, 4 Drawing Sheets

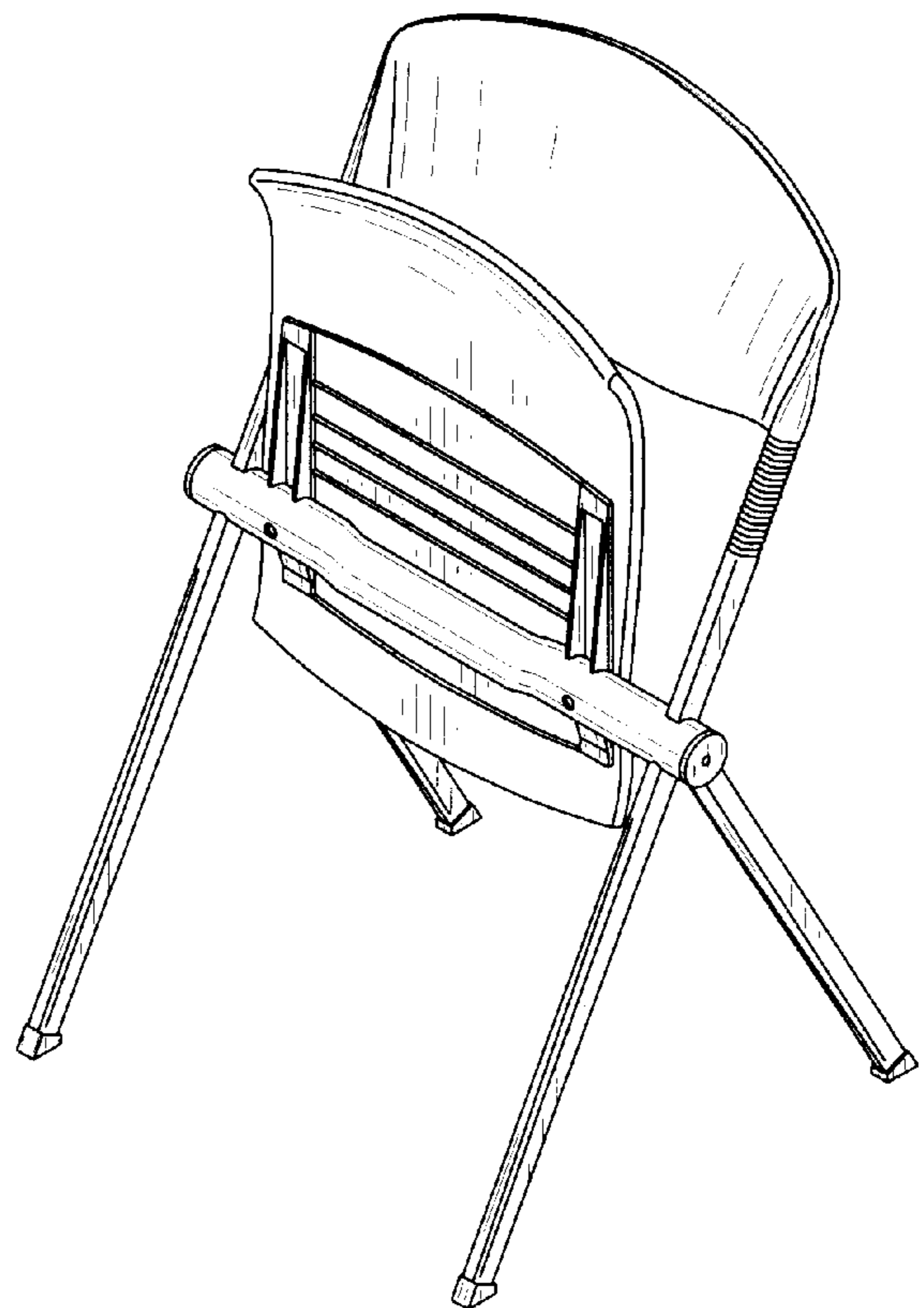
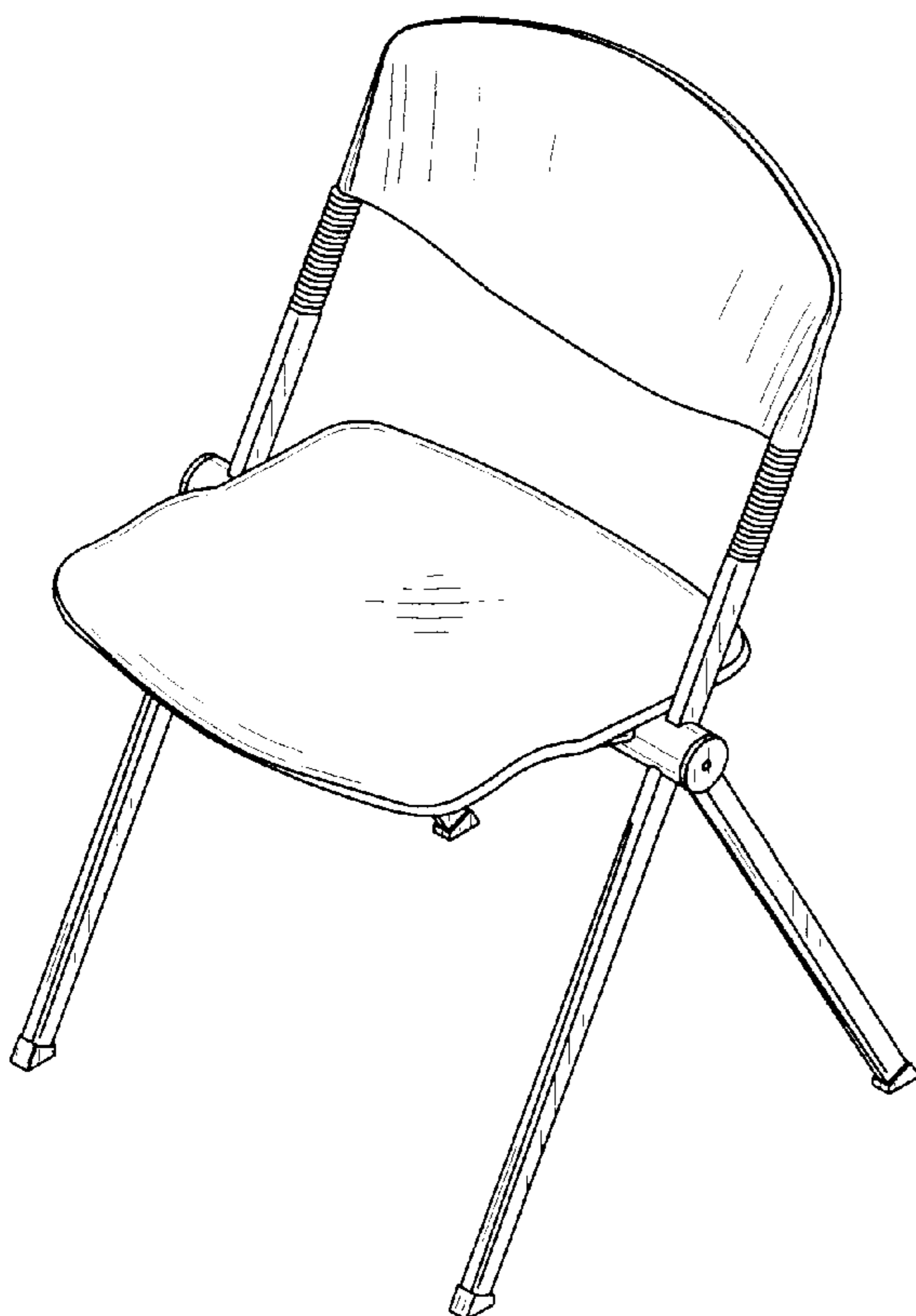

FIG. 1

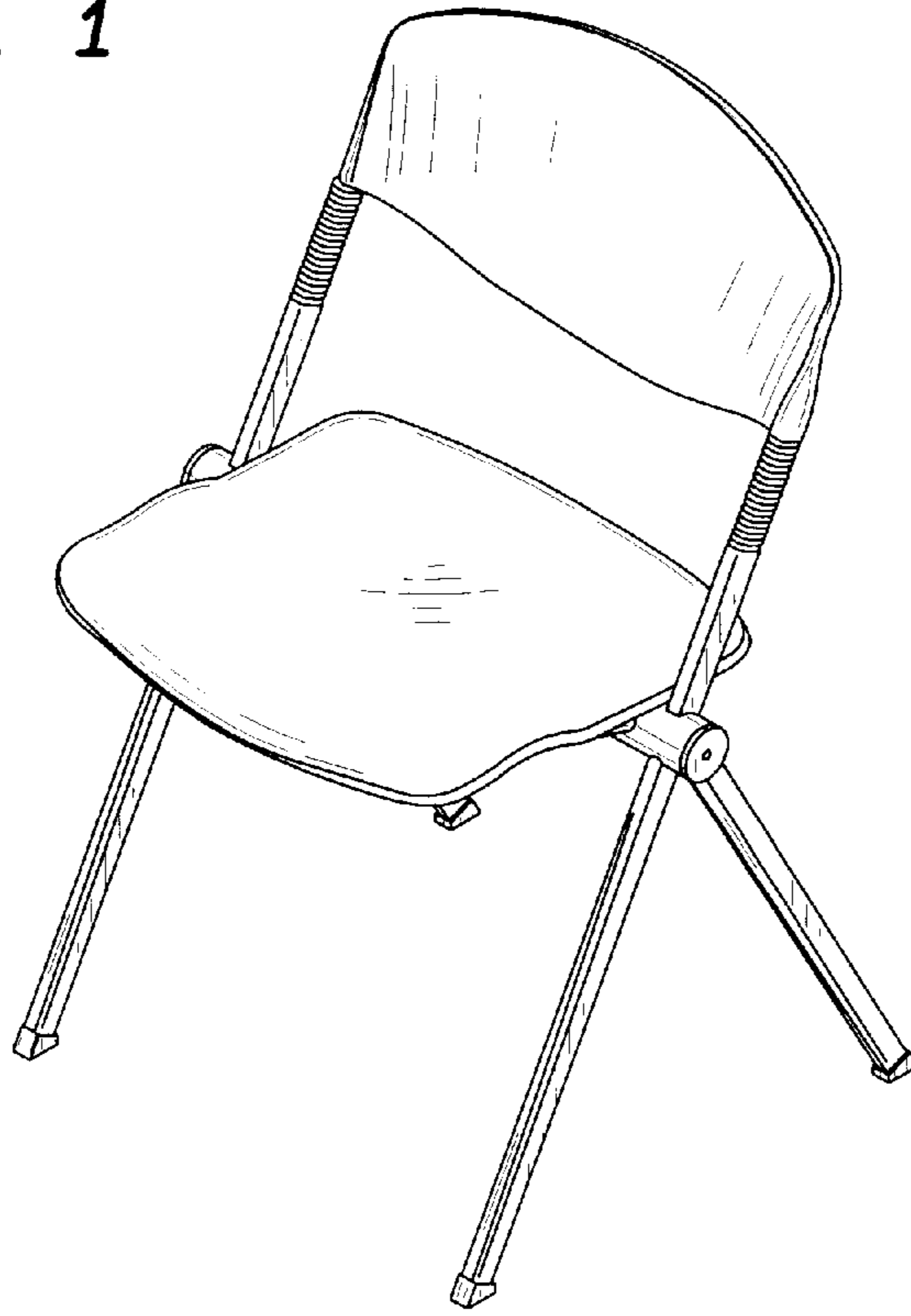

FIG. 2

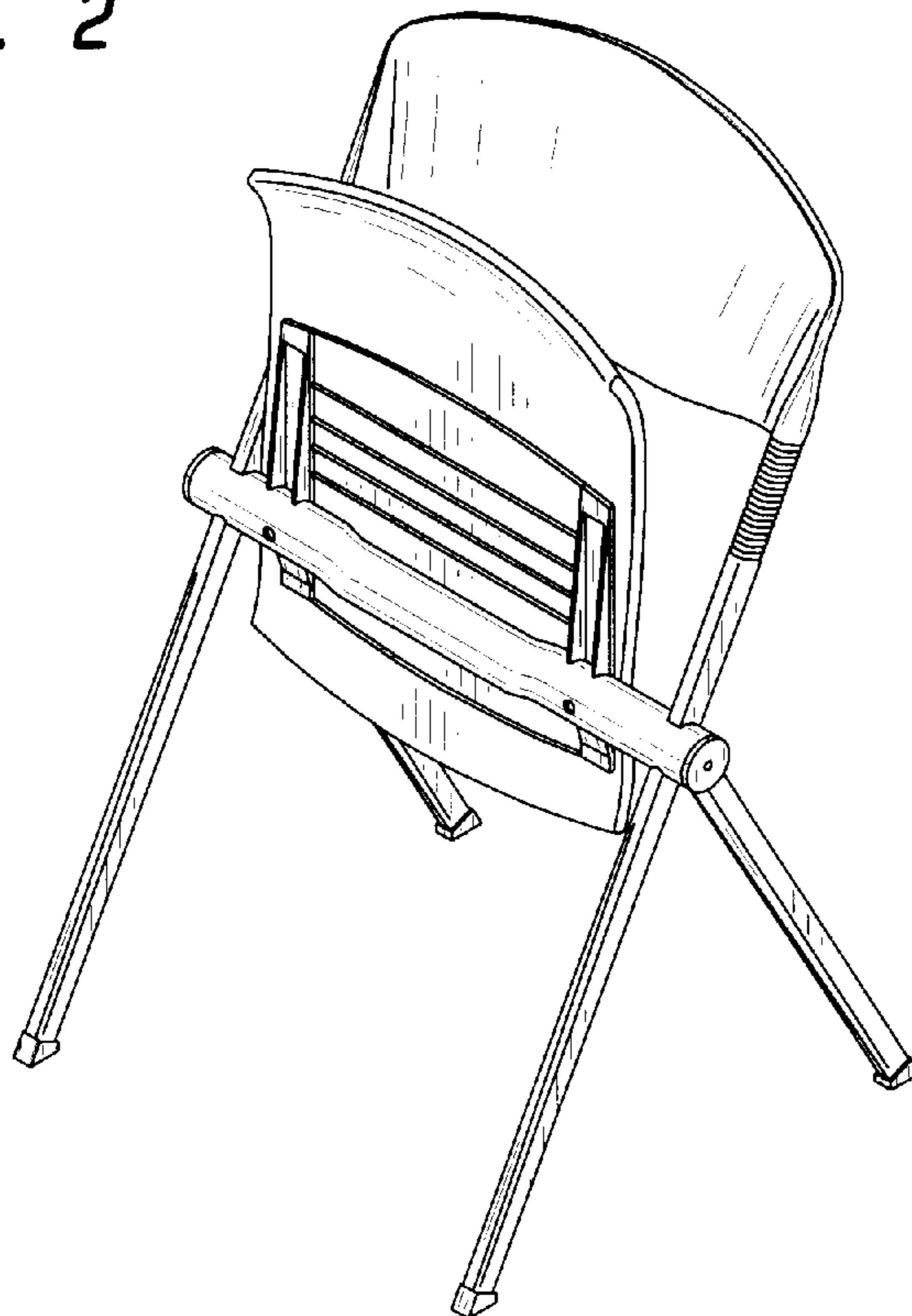

FIG. 3

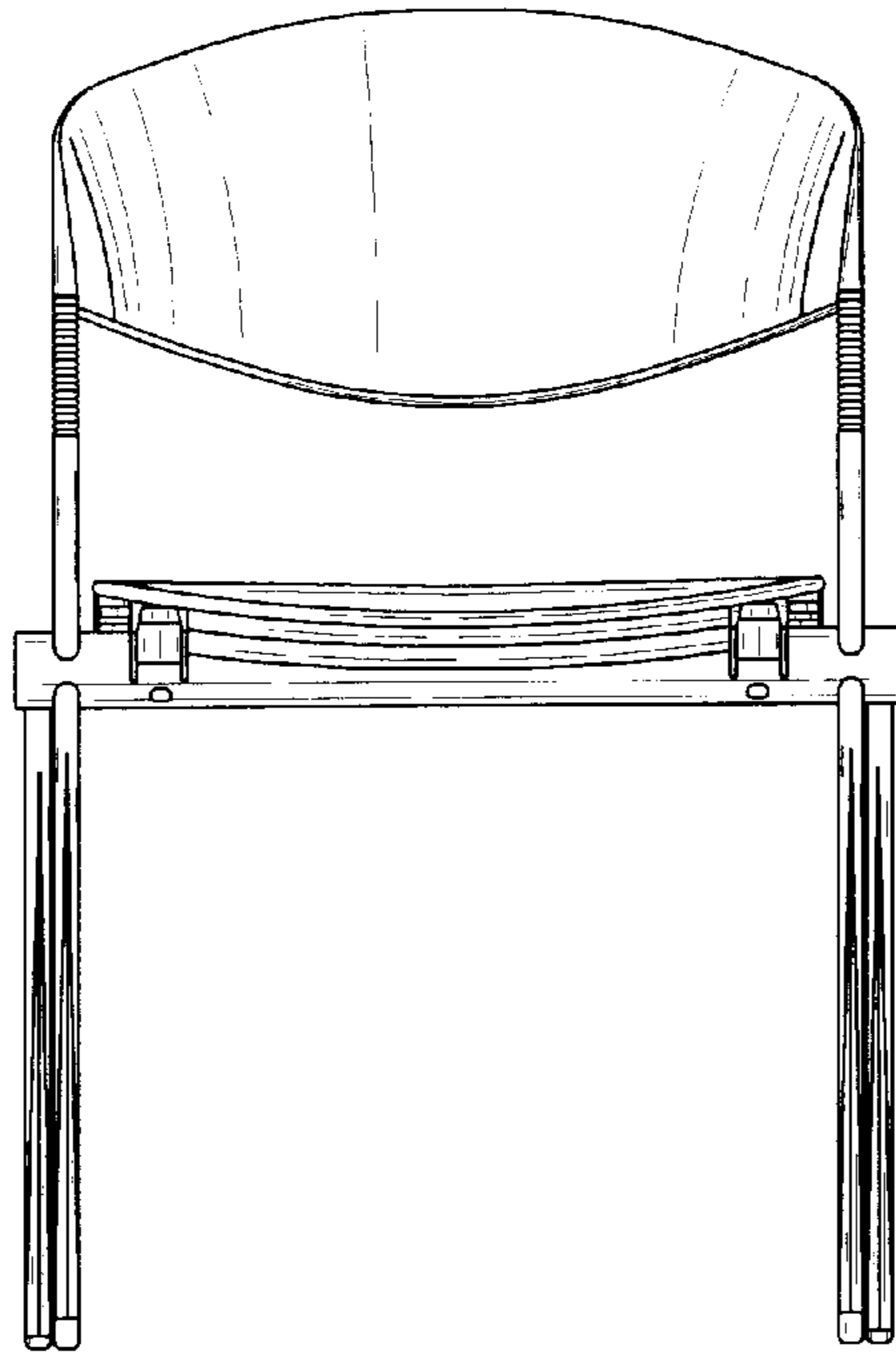

FIG. 4

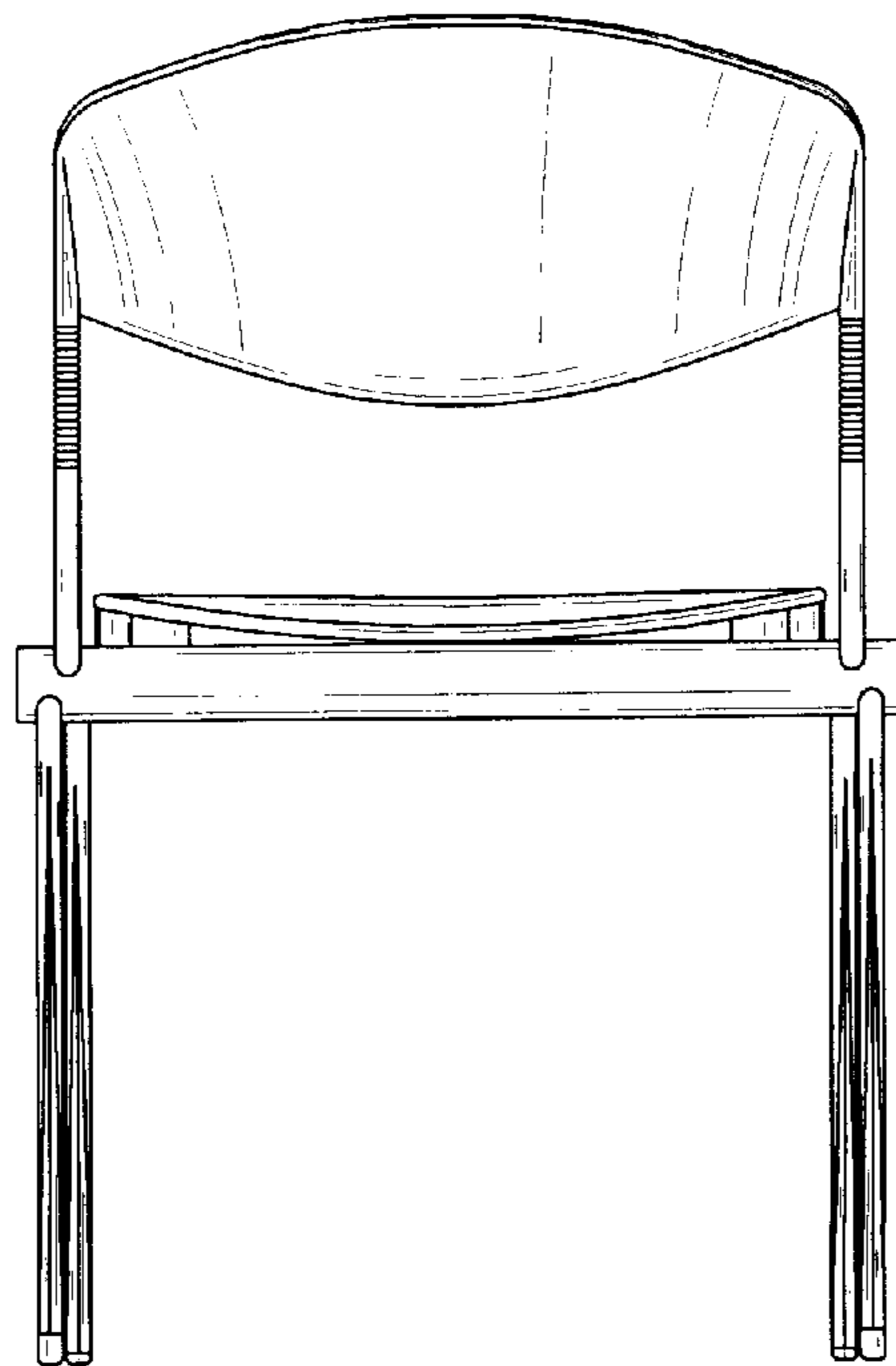

FIG. 5

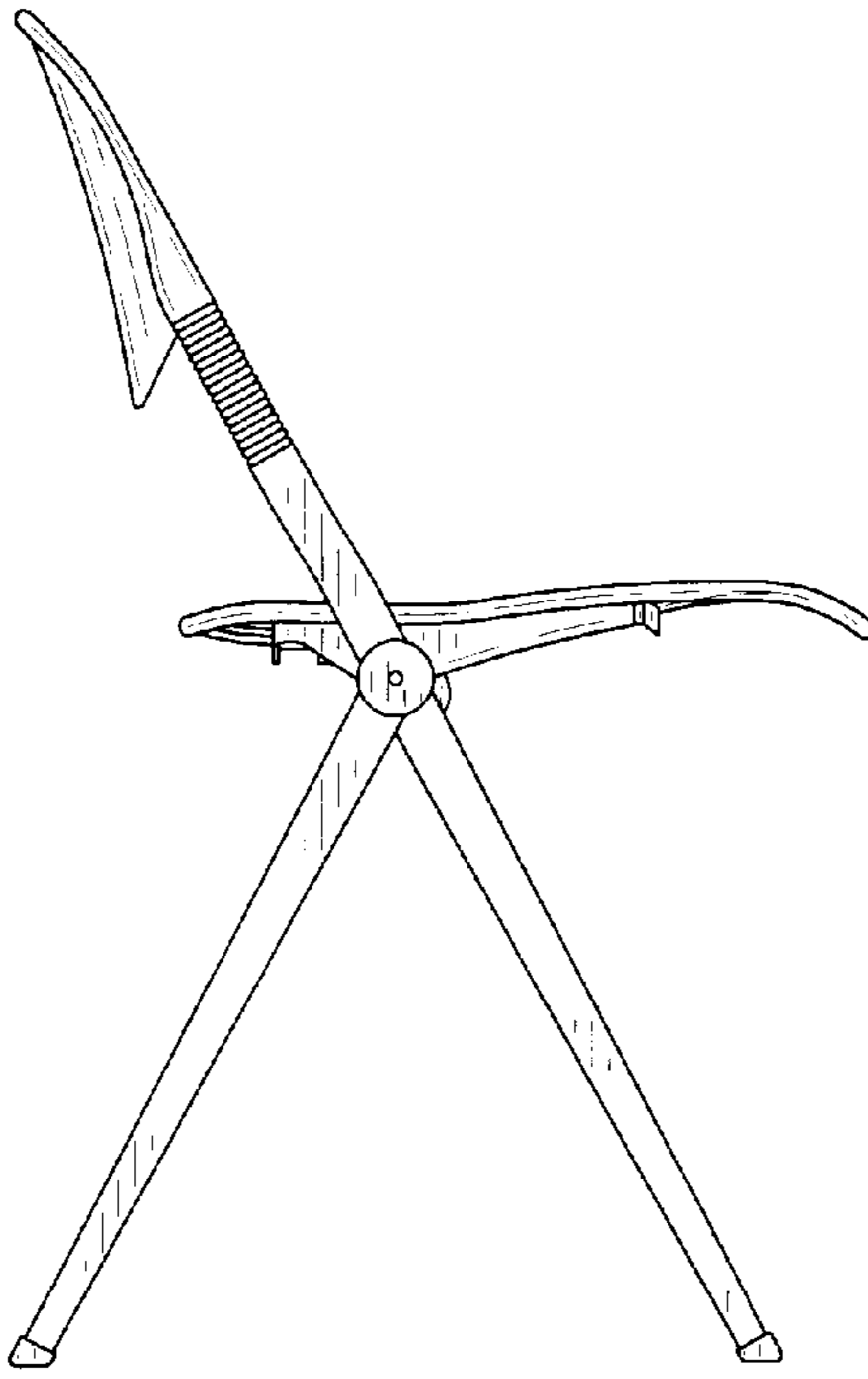

FIG. 6

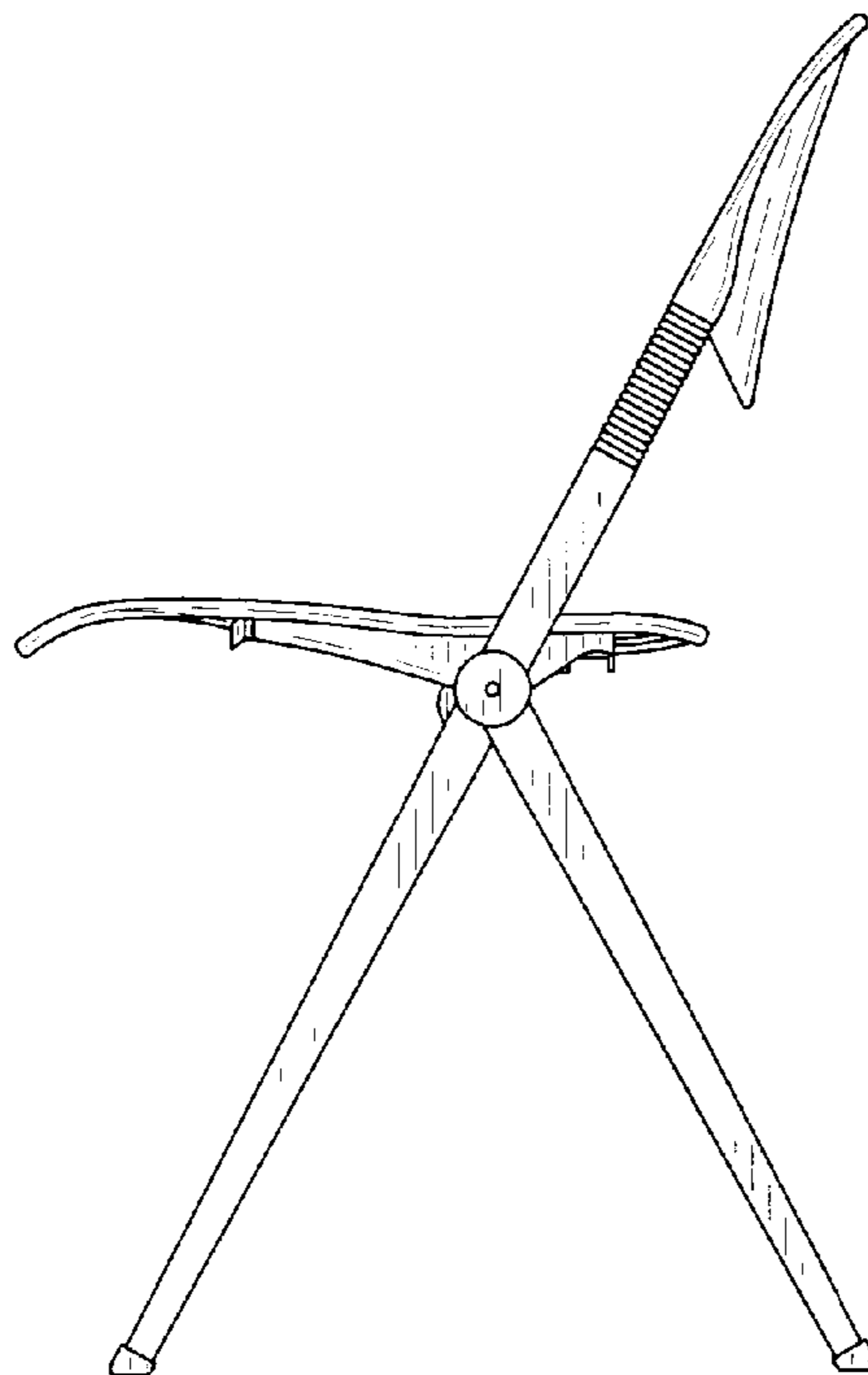

FIG. 7

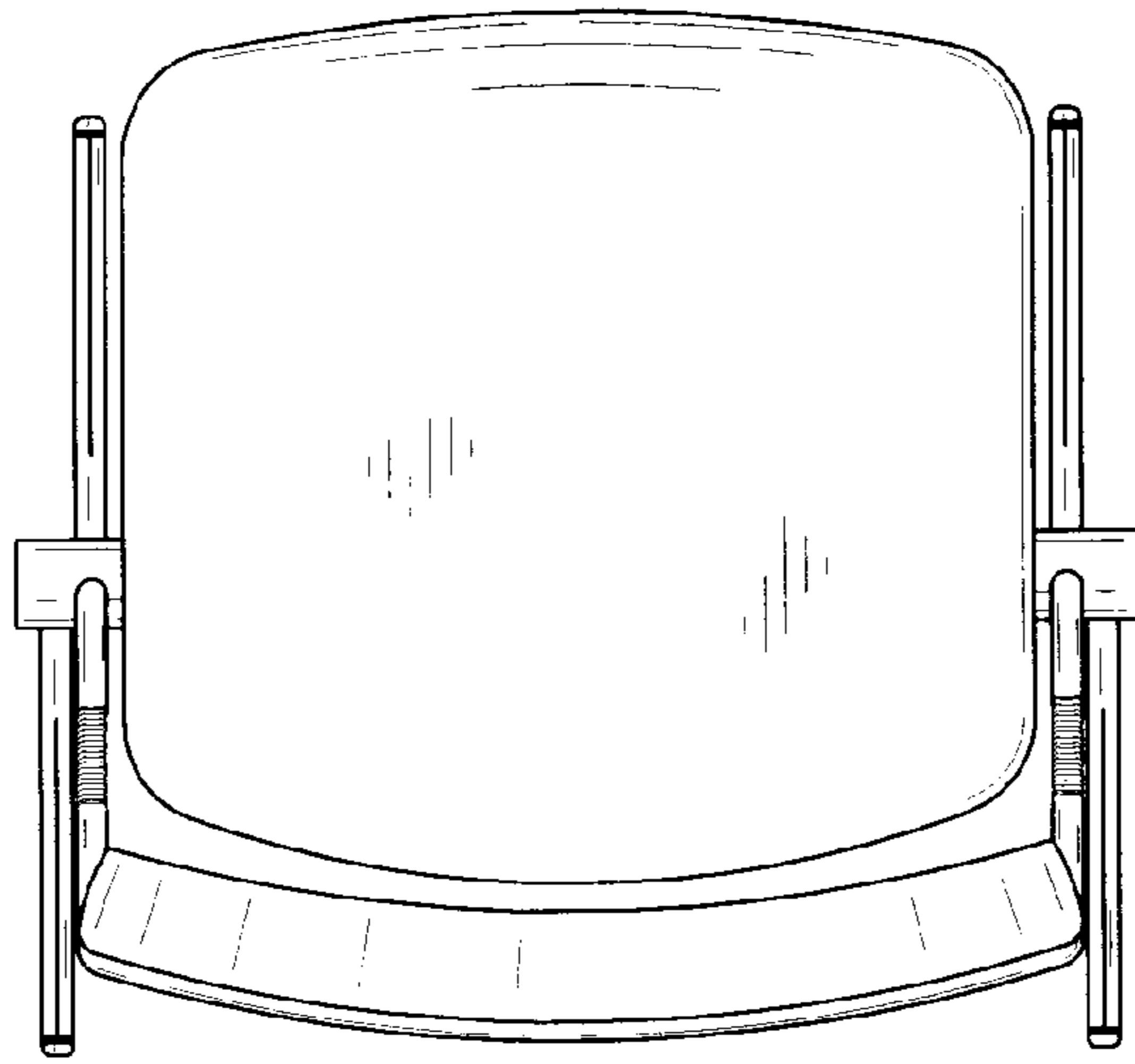

FIG. 8

