



US00D436455S

(12) **United States Design Patent**
Zamora

(10) **Patent No.:** **US D436,455 S**

(45) **Date of Patent:** **** Jan. 23, 2001**

(54) **SADDLE COMFORT SEAT**

Primary Examiner—Melody N. Brown

(76) **Inventor:** **Juanito D. Zamora**, 15 Prince Rd.
East, Santa Fe, NM (US) 87505

(57) **CLAIM**

(**) **Term:** **14 Years**

The ornamental design for a saddle comfort seat, as shown and described.

(21) **Appl. No.:** **29/061,909**

DESCRIPTION

(22) **Filed:** **Nov. 1, 1996**

(51) **LOC (7) Cl.** **06-06**

(52) **U.S. Cl.** **D6/354; D12/114**

(58) **Field of Search** **D6/354; D12/114,**
D12/120, 409; 297/195.1, 195.11

FIG. 1 is a front and right side perspective view of a saddle comfort seat showing my new design;

FIG. 2 is a left side perspective view thereof;

FIG. 3 is a bottom plan view thereof;

FIG. 4 is a rear perspective view thereof;

FIG. 5 is a top perspective view thereof, the broken lines are for illustrative purposes only and form no part of the claimed design; and,

FIG. 6 is a right side perspective view of FIG. 5.

(56) **References Cited**

U.S. PATENT DOCUMENTS

- D. 246,879 * 1/1978 Hanagan D6/354
- D. 271,163 * 11/1983 Johnson D6/354
- D. 301,409 * 6/1989 Beckett D6/354

OTHER PUBLICATIONS

Drag Specialties Catalog, p. 43, the FXDL Solo Saddle and Pillion Seat, ©1995.*

* cited by examiner

1 Claim, 2 Drawing Sheets

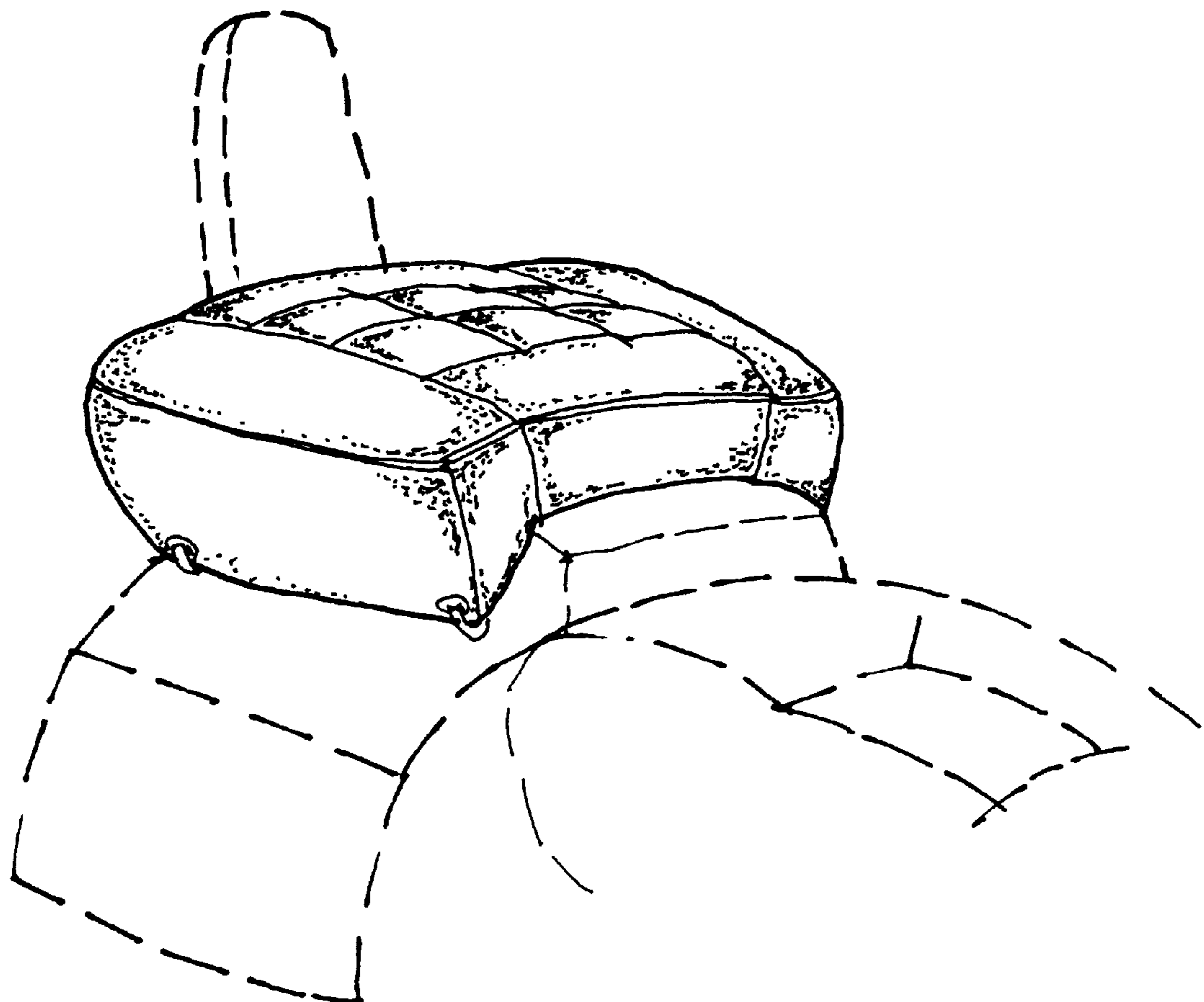

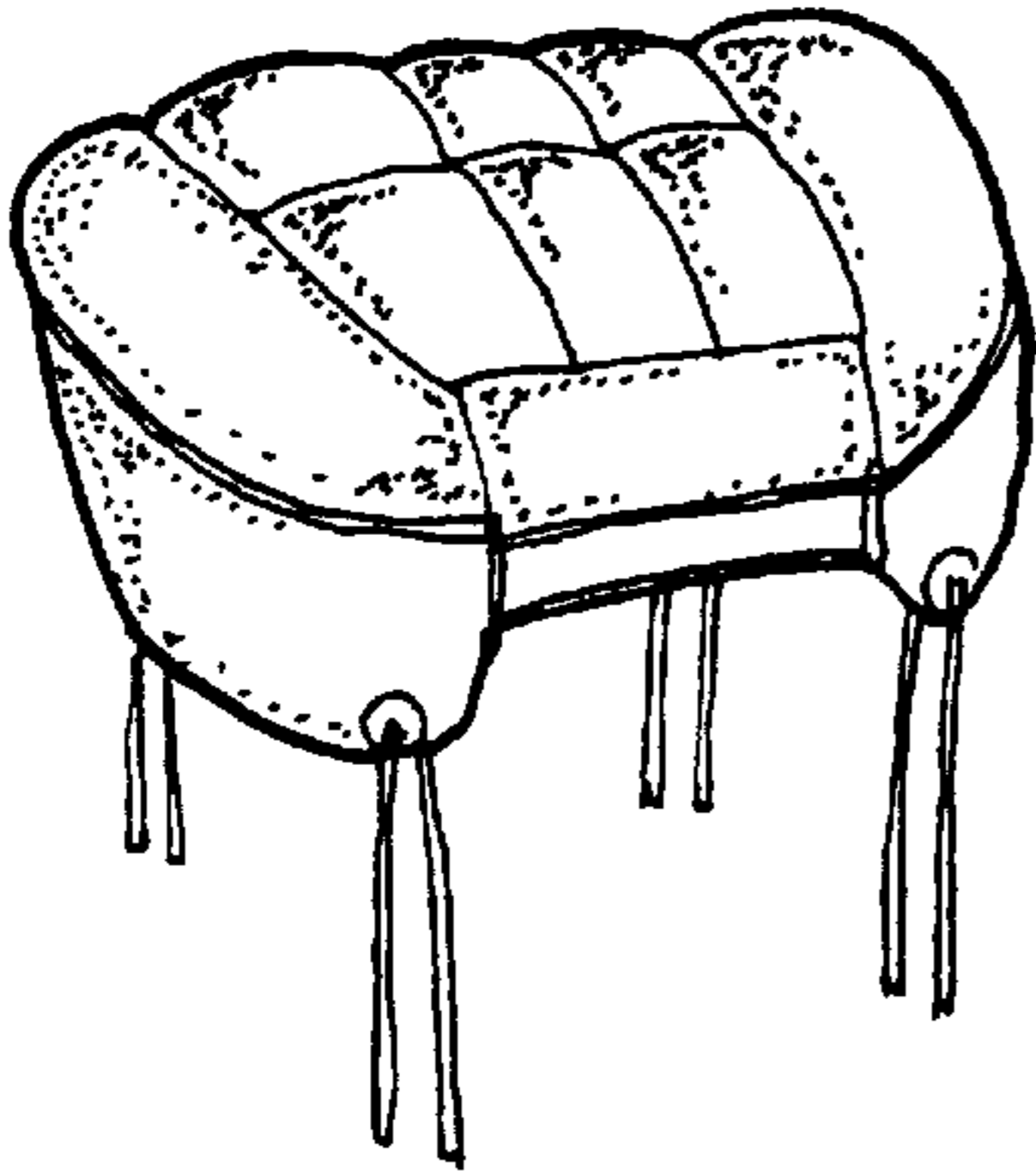

FIG. 1

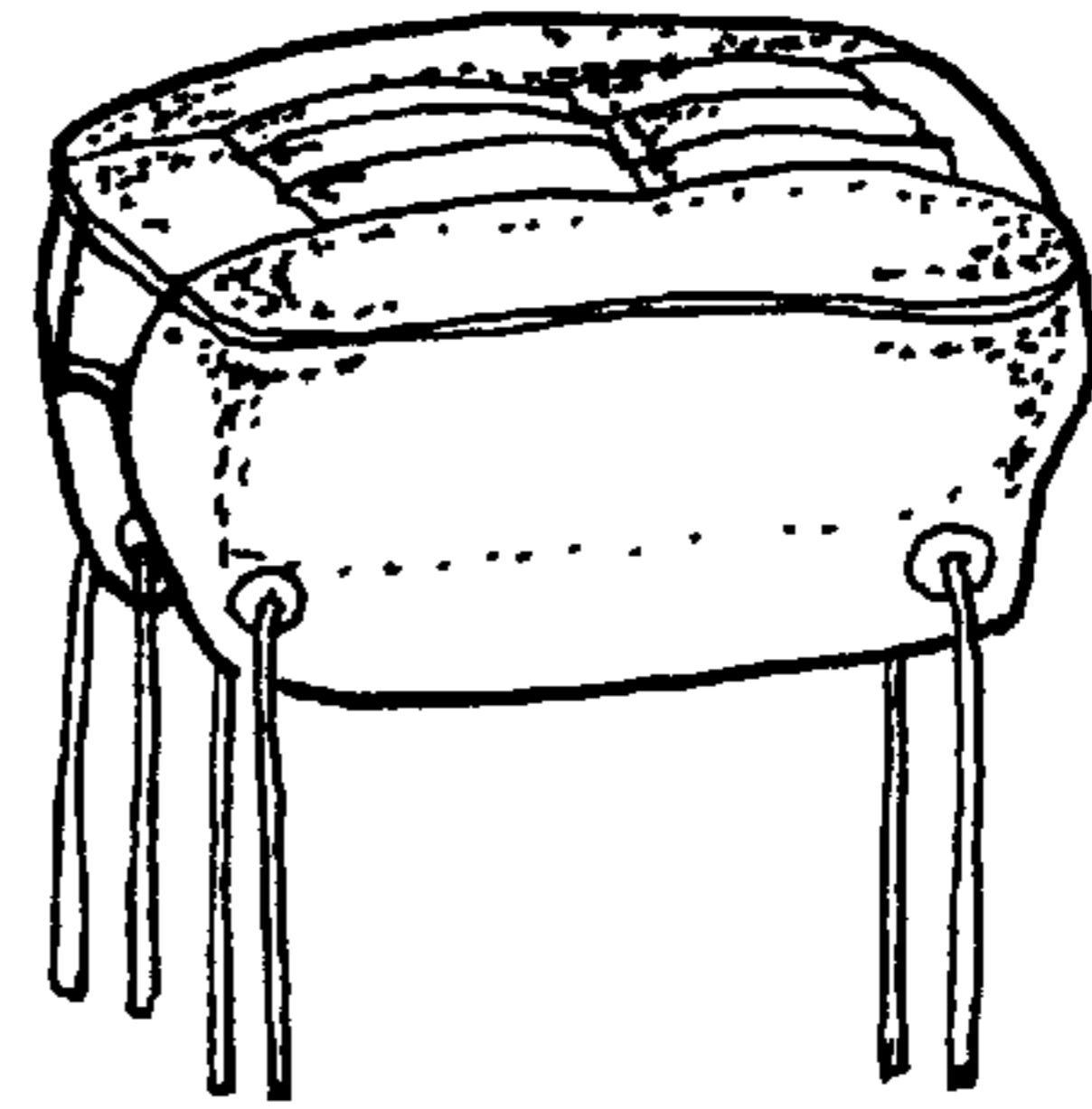

FIG. 2

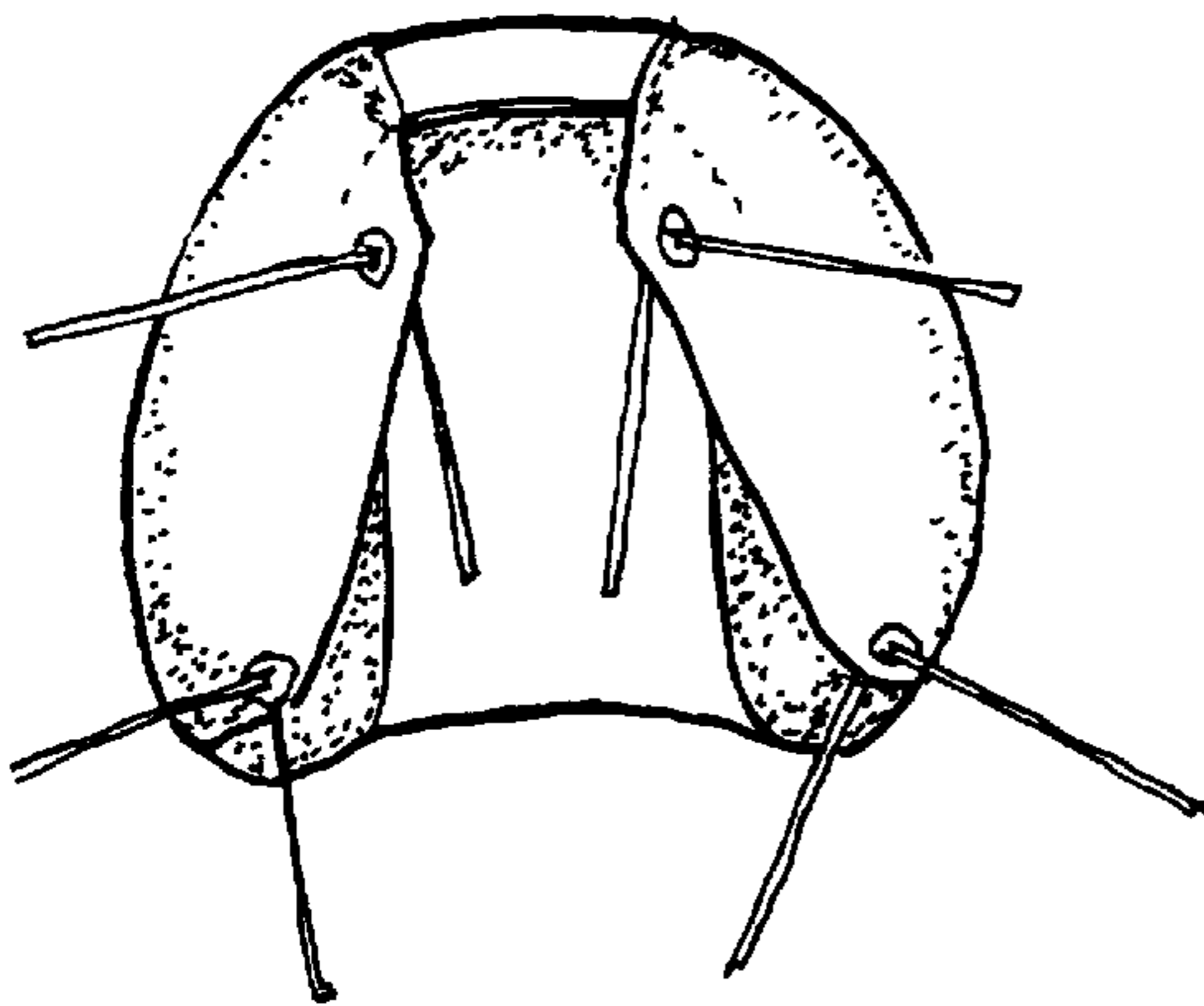

FIG. 3

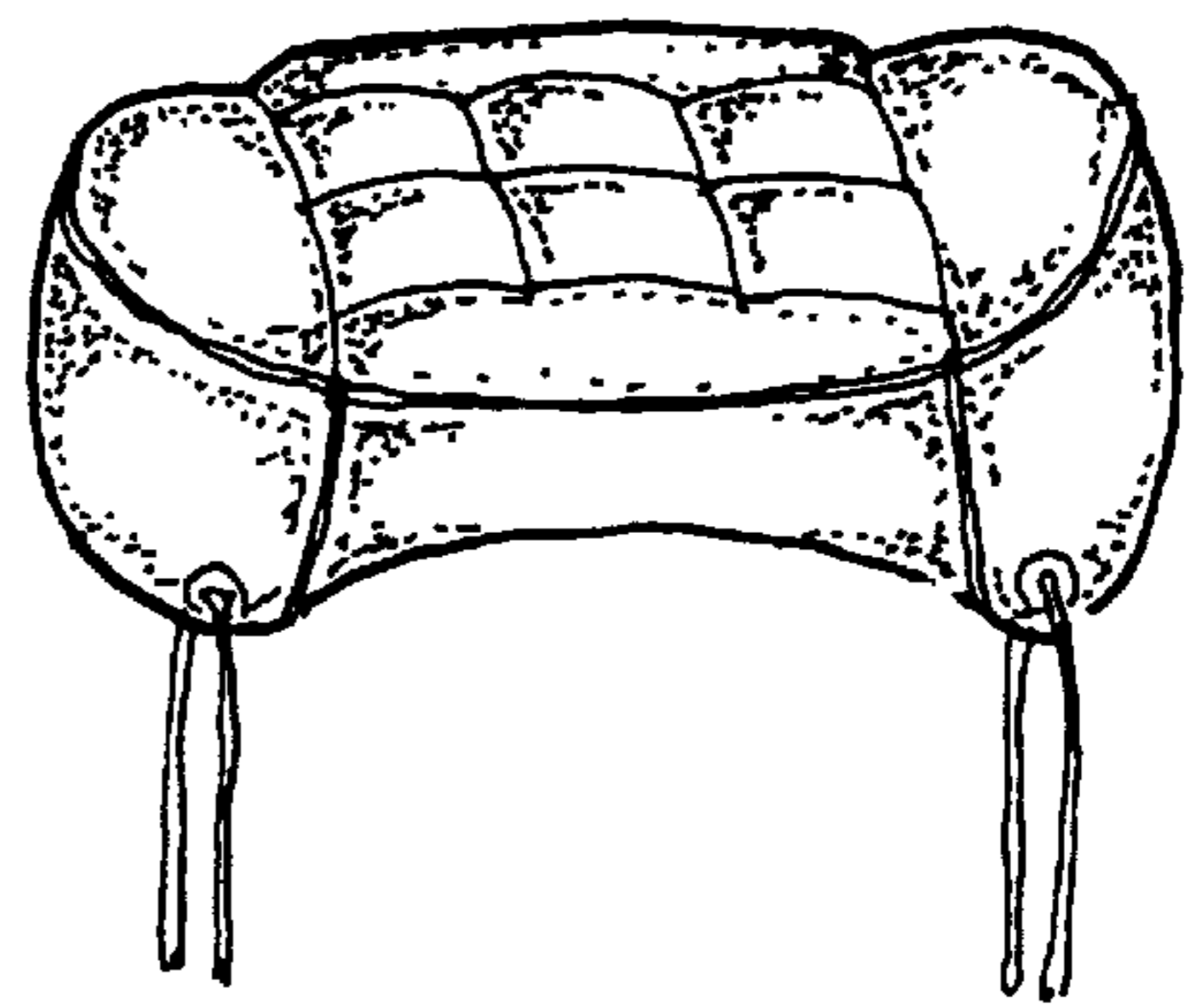

FIG. 4

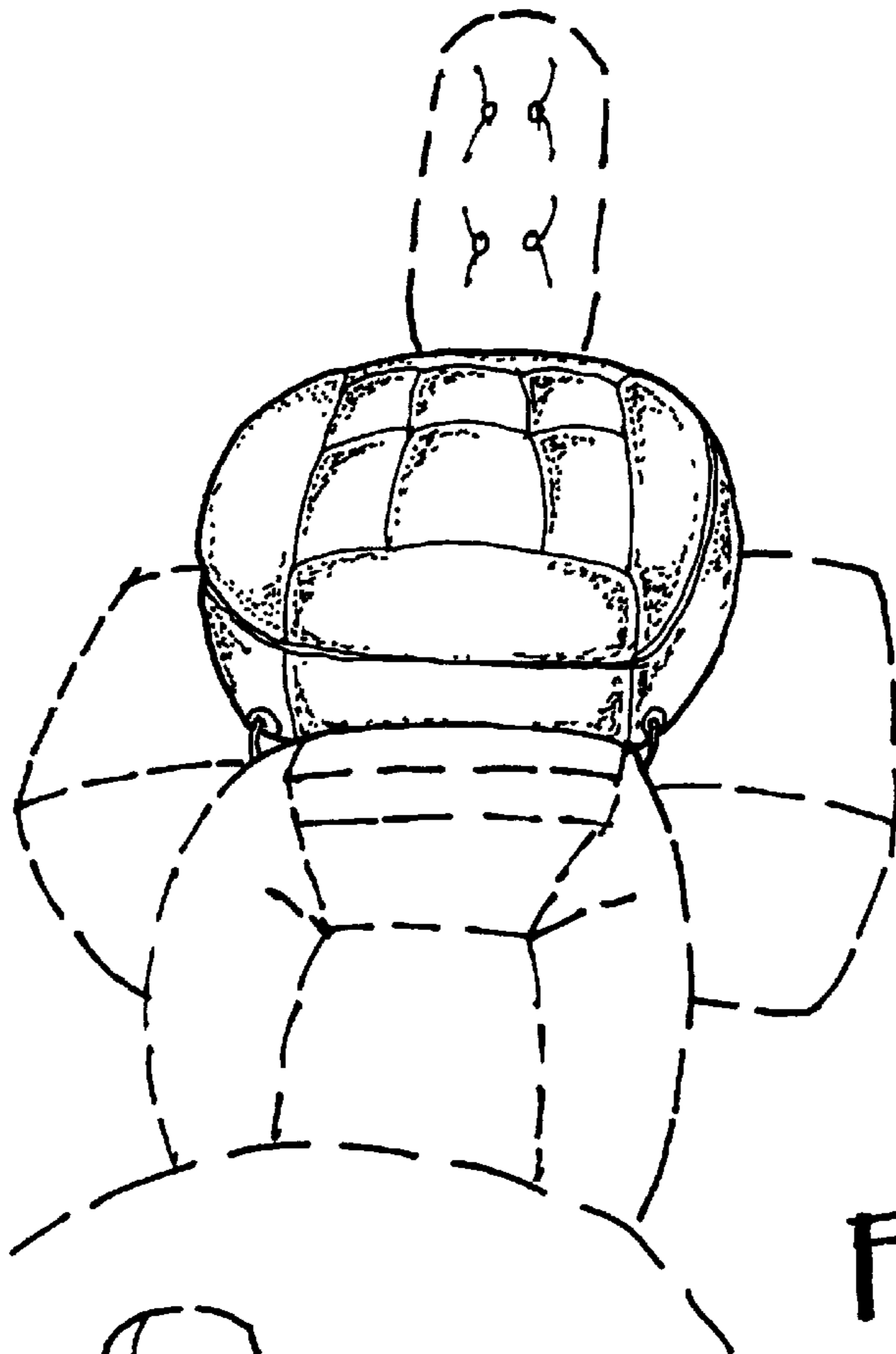

FIG. 5

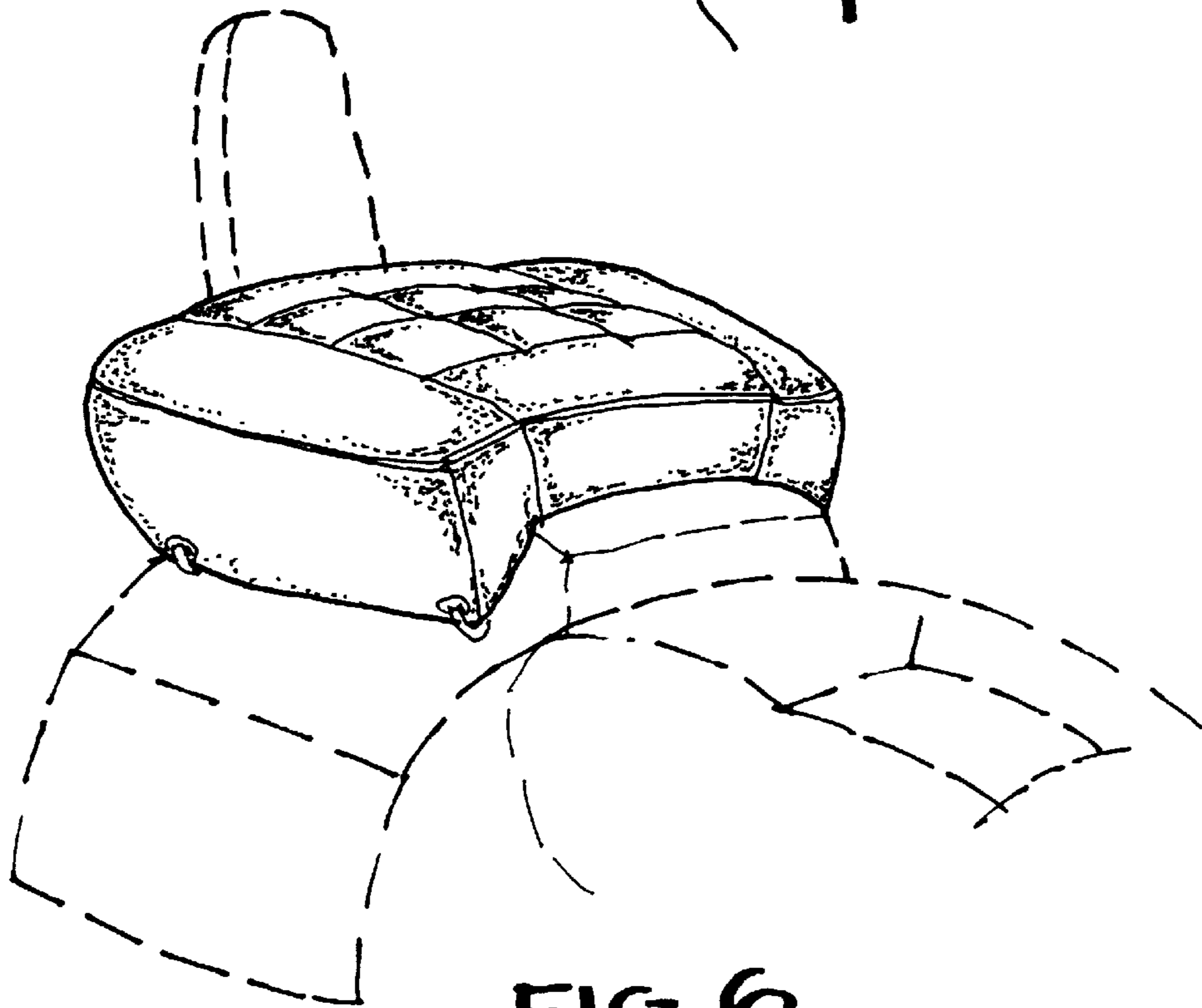

FIG. 6