



US00D436440S

(12) **United States Design Patent**
Stokes

(10) **Patent No.:** US D436,440 S
(45) **Date of Patent:** ** Jan. 23, 2001

(54) **COMBINATION GOLF BAG AND TRAVEL CASE WITH ACCESSORY BAG**

DESCRIPTION

(76) **Inventor:** Richard B. Stokes, 12 Farview Dr., Anandale, NJ (US) 08801

(**) **Term:** 14 Years

(21) **Appl. No.:** 29/117,897

(22) **Filed:** Feb. 1, 2000

(51) **LOC (7) Cl.** 03-01

(52) **U.S. Cl.** D3/255

(58) **Field of Search** D3/255, 254, 272, D3/273, 276; 206/315.2-315.8

(56) **References Cited**

U.S. PATENT DOCUMENTS

D. 349,402	*	8/1994	Fiore	D3/255
D. 382,397	*	8/1997	Wu	D3/255
D. 394,950	*	6/1998	Kite	D3/255
D. 414,035		9/1999	Stokes	.	
D. 421,838	*	3/2000	Bradshaw et al.	D3/255

* cited by examiner

Primary Examiner—Louis S. Zarfes

Assistant Examiner—Catherine R. Oliver

(74) *Attorney, Agent, or Firm*—Duane C. Basch

(57) **CLAIM**

The ornamental design for a “combination golf bag and travel case with accessory bag”, as shown and described.

The claimed “combination golf bag and travel case with accessory bag” is used to store and transport golf clubs and accessory items.

FIG. 1 is a perspective view of the top, front and right side of the combination golf bag and travel case with accessory bag, with the cover removed;

FIG. 2 is a perspective view with the shoulder strap and accessory bag removed for convenience of illustration;

FIG. 3 is a front elevation view of the case with the accessory bag installed and hanging on the rear;

FIG. 4 is a right side elevation view of the case with the accessory bag installed and hanging to the right on the rear side;

FIG. 5 is a rear elevation view of the case with the accessory bag installed;

FIG. 6 is a left side elevation view of the case with the accessory bag installed and hanging to the left on the rear side;

FIG. 7 is a top plan view of the case;

FIG. 8 is a right side elevation view of the cover;

FIG. 9 is a front elevation view of the cover;

FIG. 10 is a rear elevation view of the cover;

FIG. 11 is a left side elevation view of the cover;

FIG. 12 is a top plan view of the cover; and,

FIG. 13 is a view looking into the cover from below.

The bottom of the case is flat and unornamented. The broken line showing of environment in the drawings is for illustrative purposes only and forms no part of the claimed design.

1 Claim, 6 Drawing Sheets

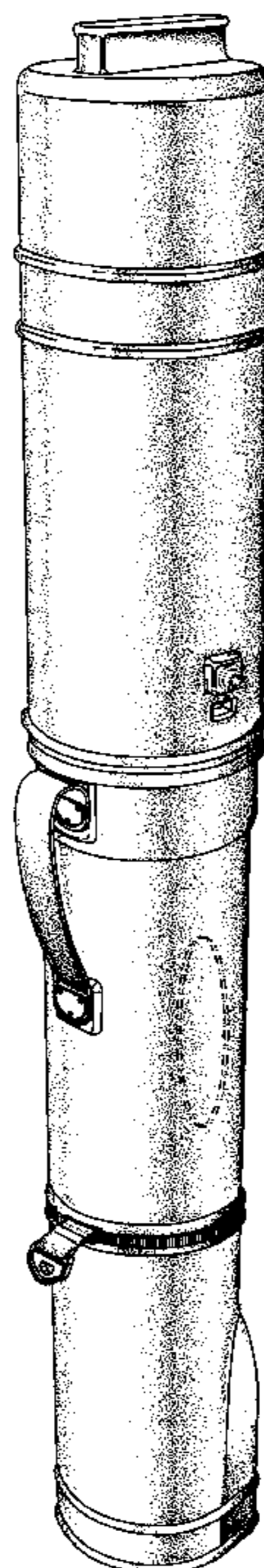

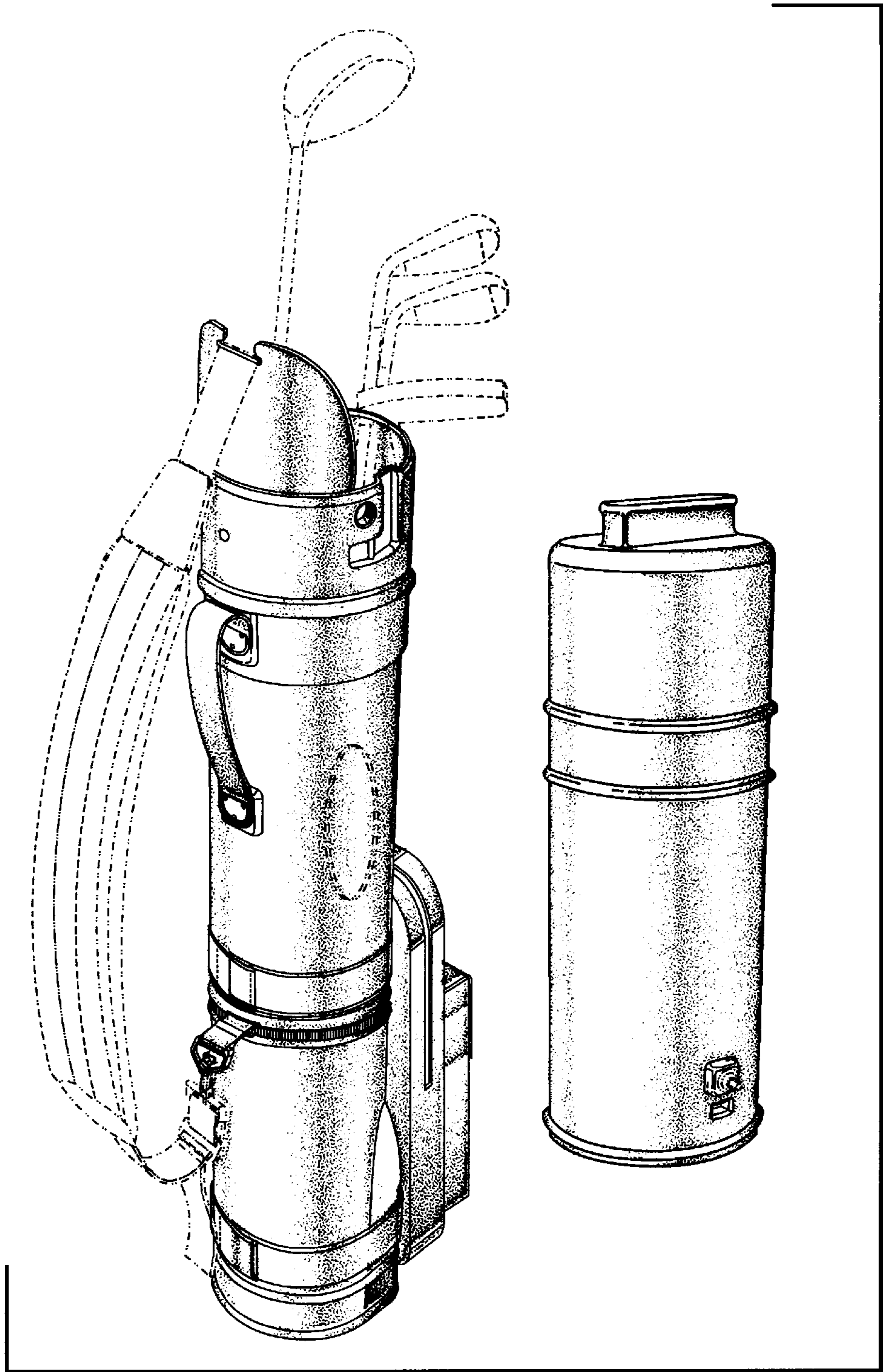

FIG. 1

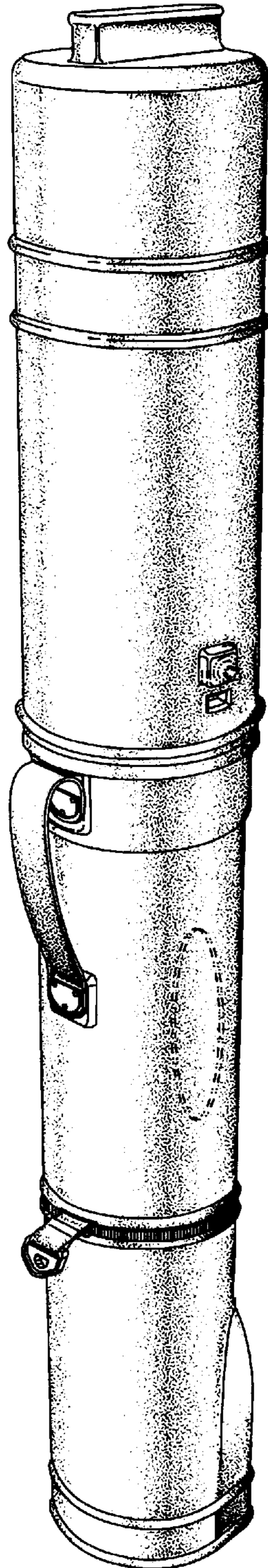

FIG. 2

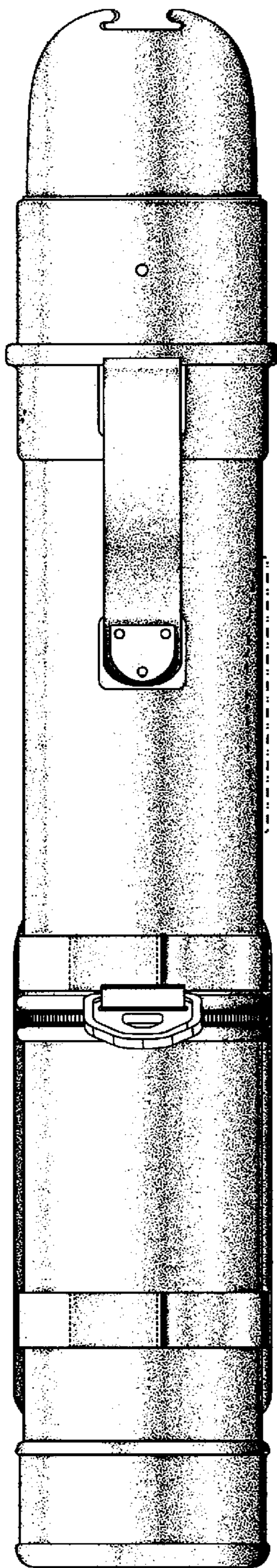

FIG. 3

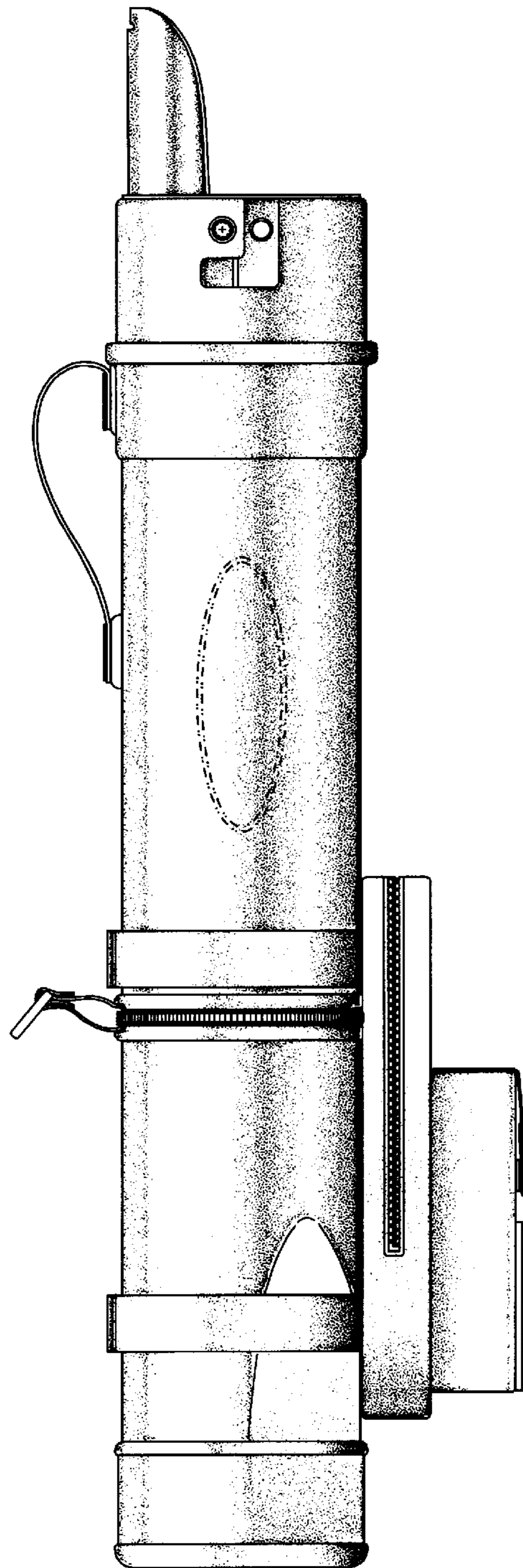

FIG. 4

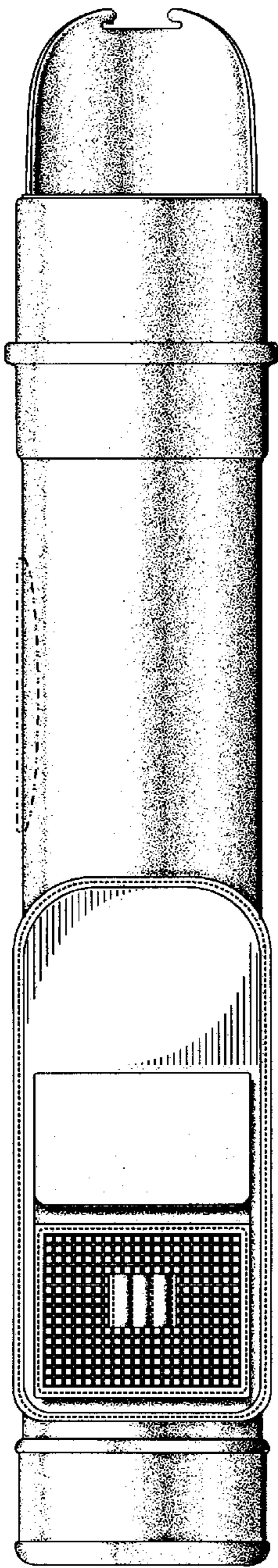

FIG. 5

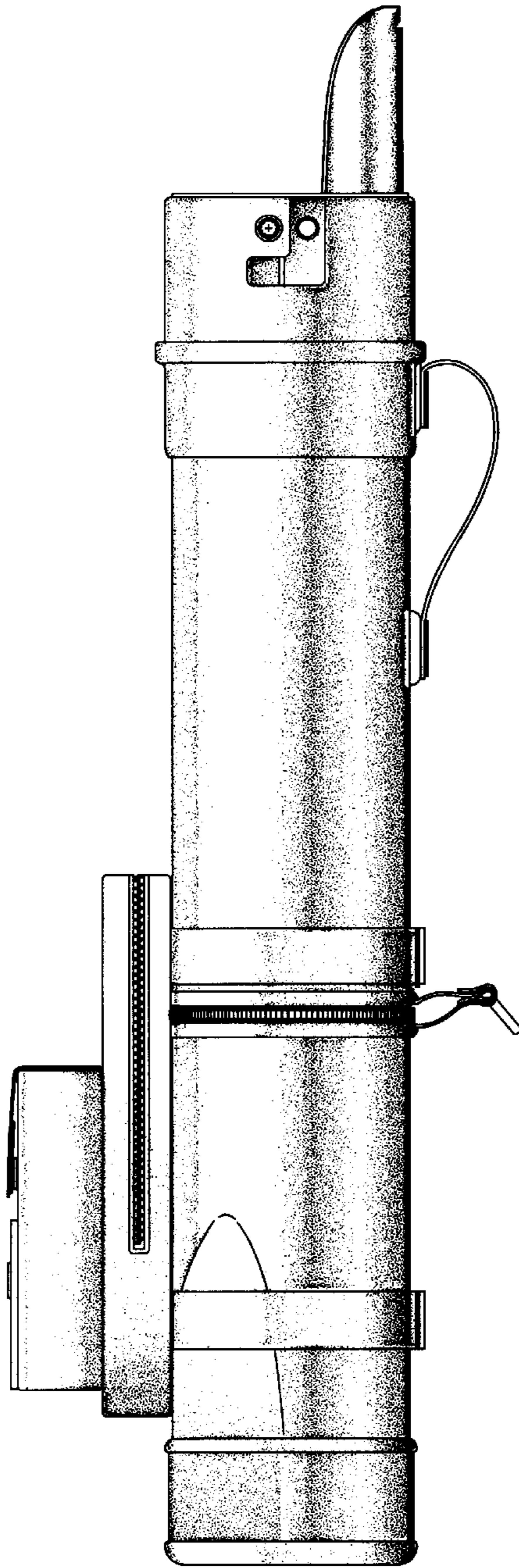

FIG. 6

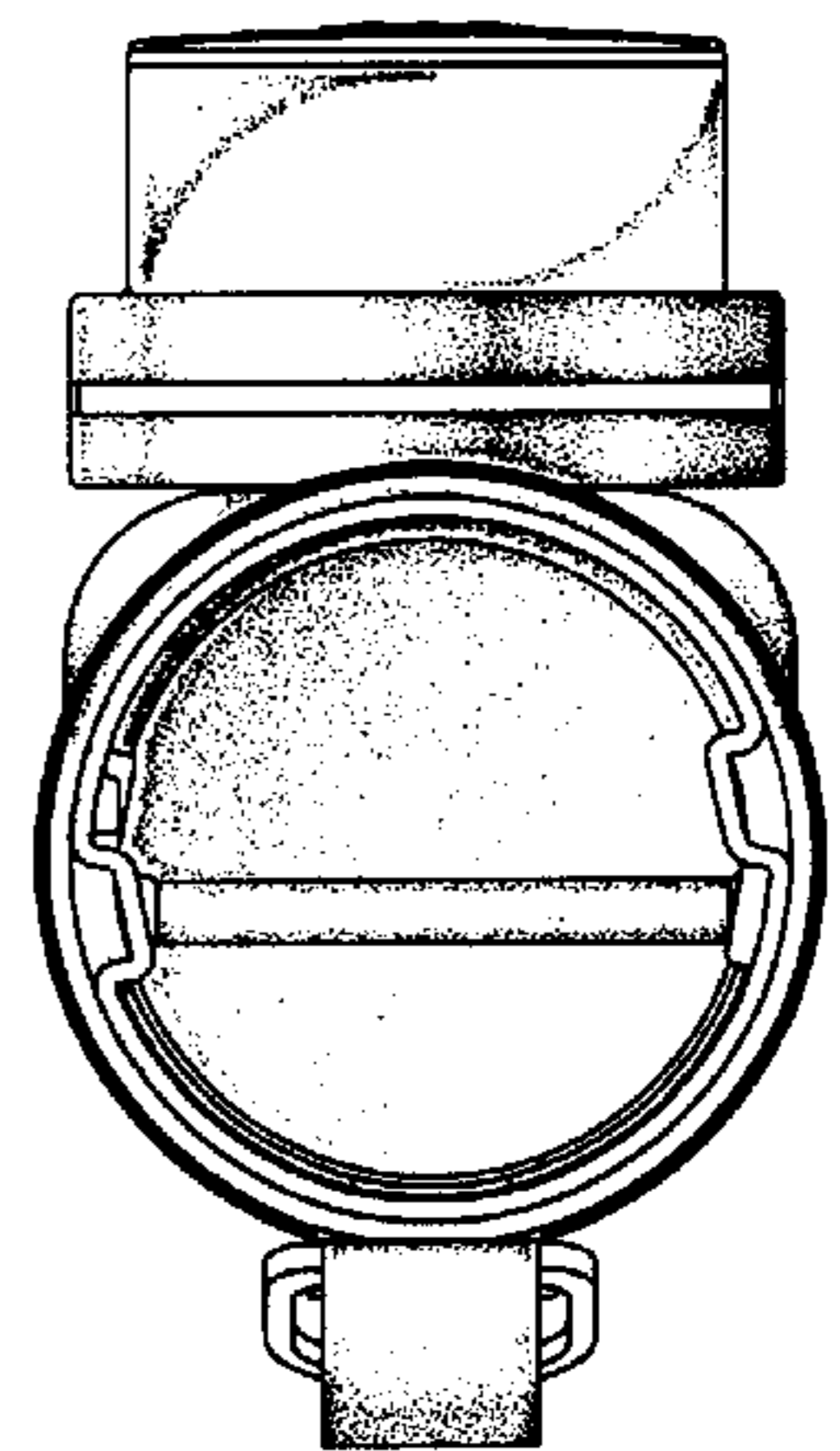

FIG. 7

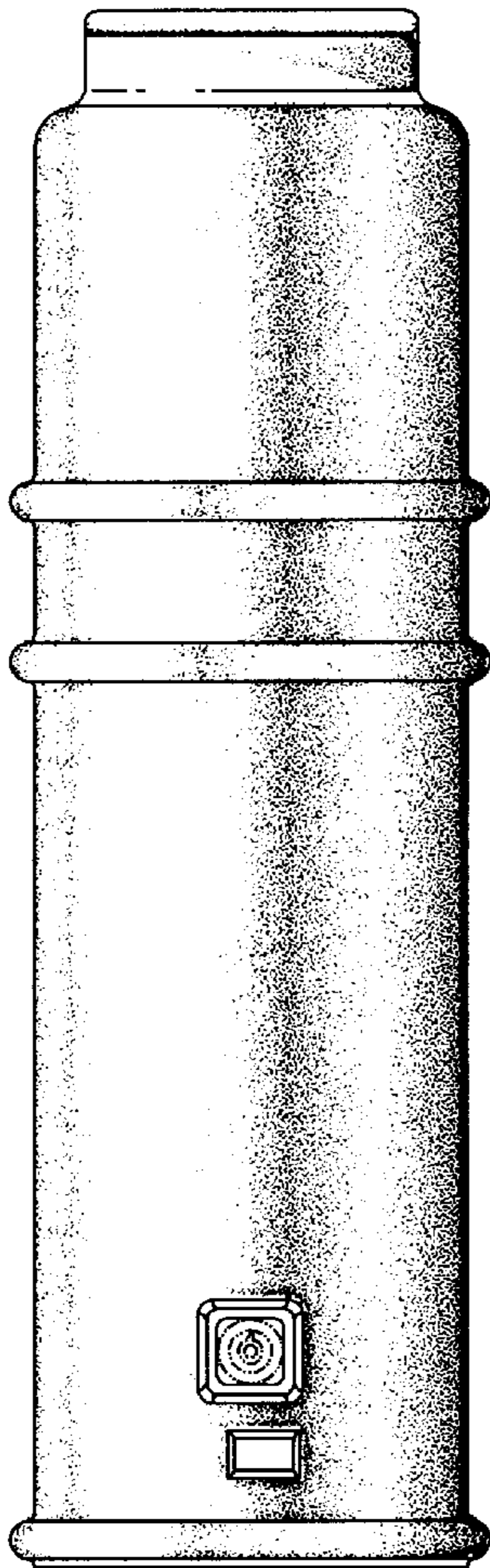

FIG. 8

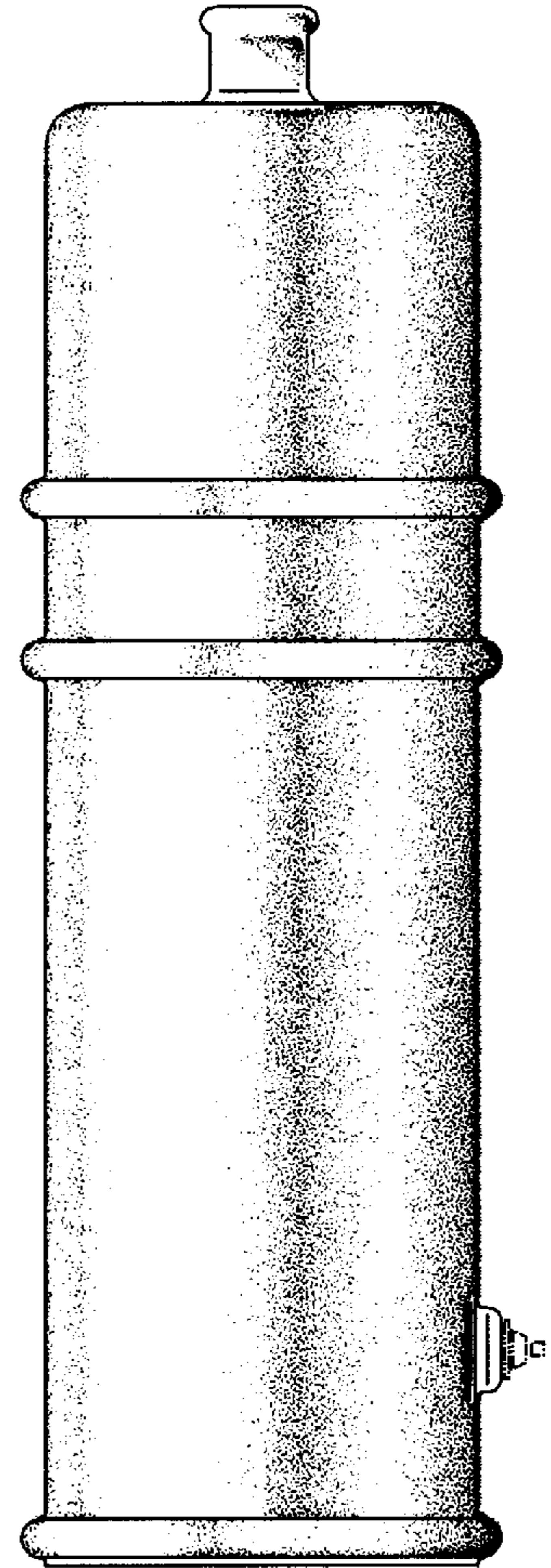

FIG. 9

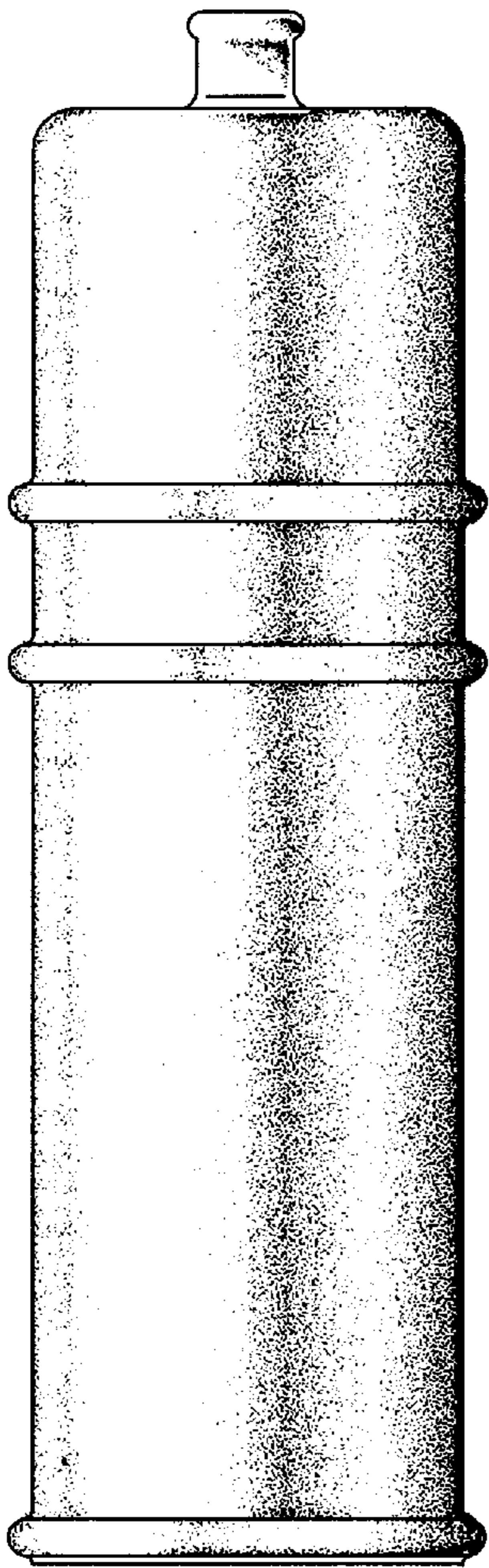

FIG. 10

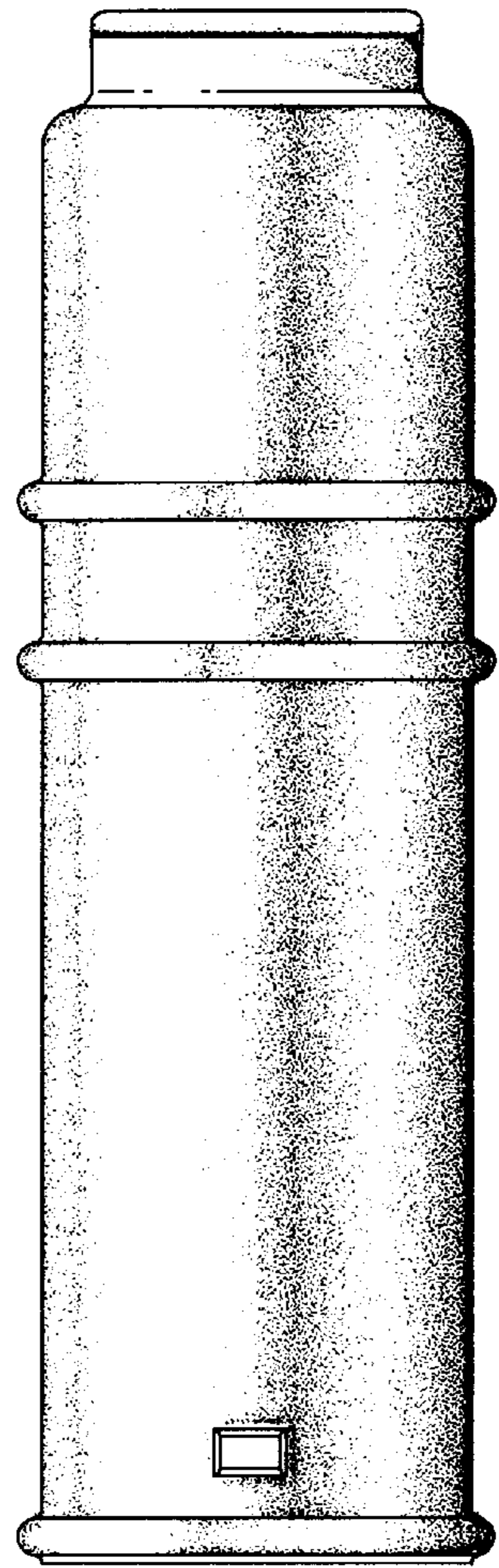

FIG. 11

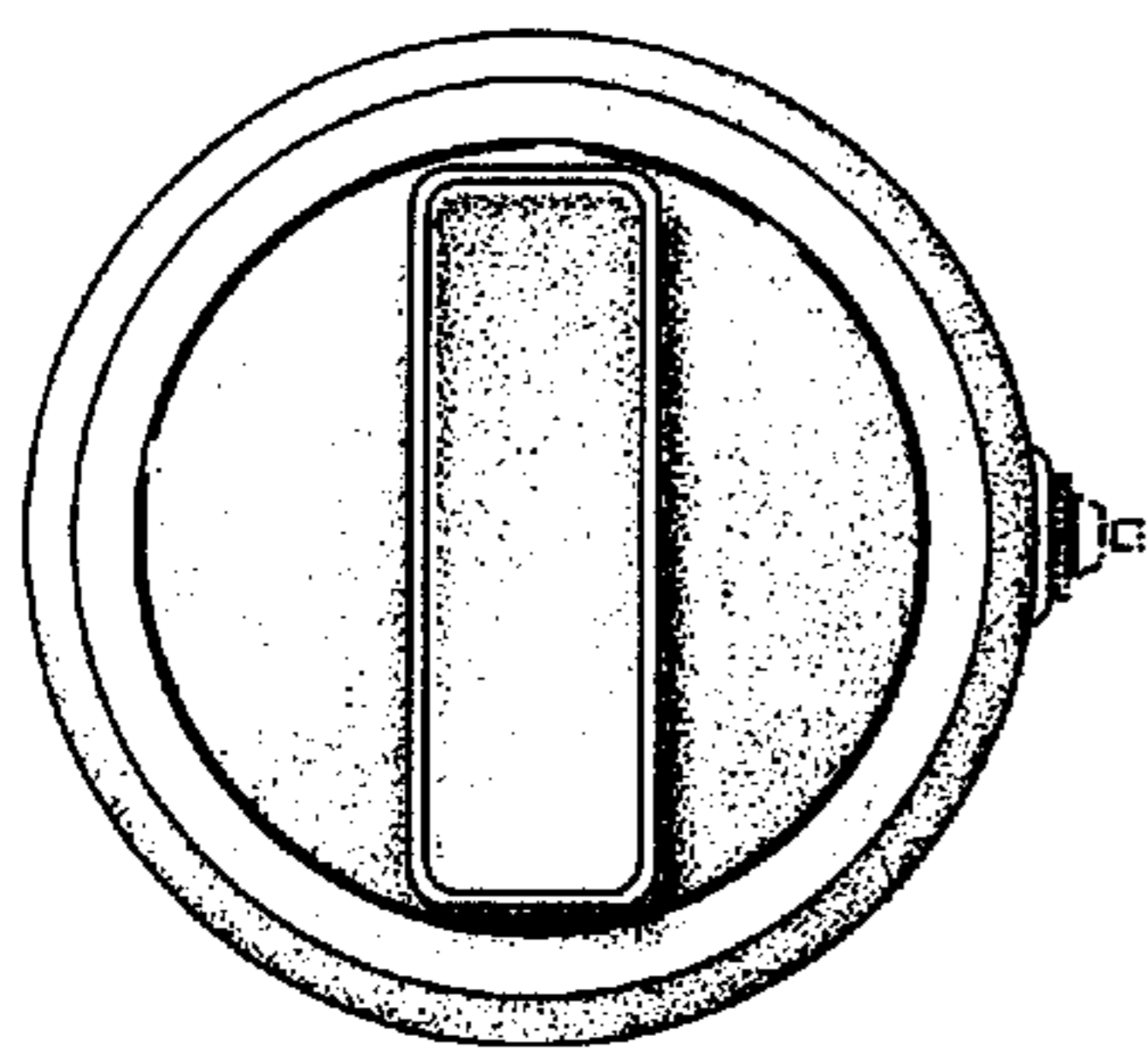

FIG. 12

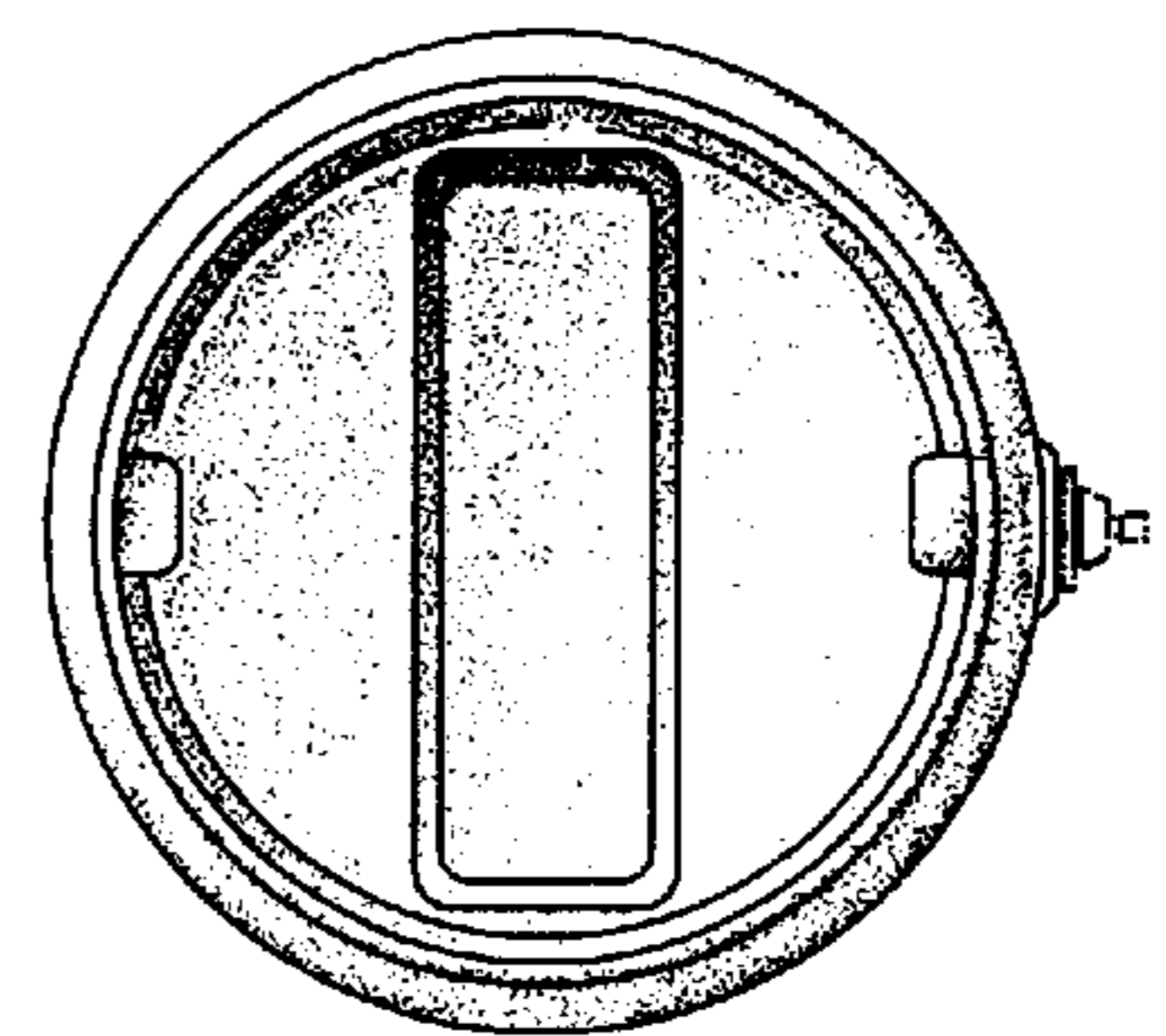

FIG. 13