



US00D436125S

(12) **United States Design Patent**
Kotaki et al.

(10) **Patent No.:** **US D436,125 S**

(45) **Date of Patent:** **** Jan. 9, 2001**

(54) **INK TANK FOR PRINTER**

(75) Inventors: **Yasuo Kotaki**, Yokohama; **Masashi Ogawa**, Kawasaki; **Tsutomu Abe**, Atsugi, all of (JP)

(73) Assignee: **Canon Kabushiki Kaisha**, Tokyo (JP)

(**) Term: **14 Years**

(21) Appl. No.: **29/116,666**

(22) Filed: **Jan. 10, 2000**

(30) **Foreign Application Priority Data**

Jul. 14, 1999 (JP) 11-18824

(51) **LOC (7) Cl.** **18-02**

(52) **U.S. Cl.** **D18/56; 346/86**

(58) **Field of Search** **D18/56; 347/86, 347/87**

(56) **References Cited**

U.S. PATENT DOCUMENTS

- D. 378,833 * 4/1997 Tashiro et al. D18/56
- D. 383,156 * 9/1997 Tashiro et al. D18/56
- D. 383,157 * 9/1997 Tashiro et al. D18/56
- D. 390,868 * 2/1998 Tashiro et al. D18/56

- D. 392,670 * 3/1998 Tashiro et al. D18/56
- D. 395,446 * 6/1998 Tashiro et al. D18/56
- D. 401,620 * 11/1998 Nozawa et al. D18/56
- D. 401,621 * 11/1998 Shimizu et al. D18/56
- 5,619,237 * 4/1997 Inoue et al. 347/86
- 5,831,652 * 11/1998 Hinami et al. 347/86

* cited by examiner

Primary Examiner—Cathy Anne MacCormac

(74) *Attorney, Agent, or Firm*—Fitzpatrick, Cella, Harper & Scinto

(57) **CLAIM**

The ornamental design for an ink tank for printer, as shown and described.

DESCRIPTION

FIG. 1 is a front view of an ink tank for printer showing our new design;
 FIG. 2 is a rear view thereof;
 FIG. 3 is a top plan view thereof;
 FIG. 4 is a bottom plan view thereof;
 FIG. 5 is a left side view thereof;
 FIG. 6 is a right side view thereof; and,
 FIG. 7 is a perspective view thereof.

1 Claim, 4 Drawing Sheets

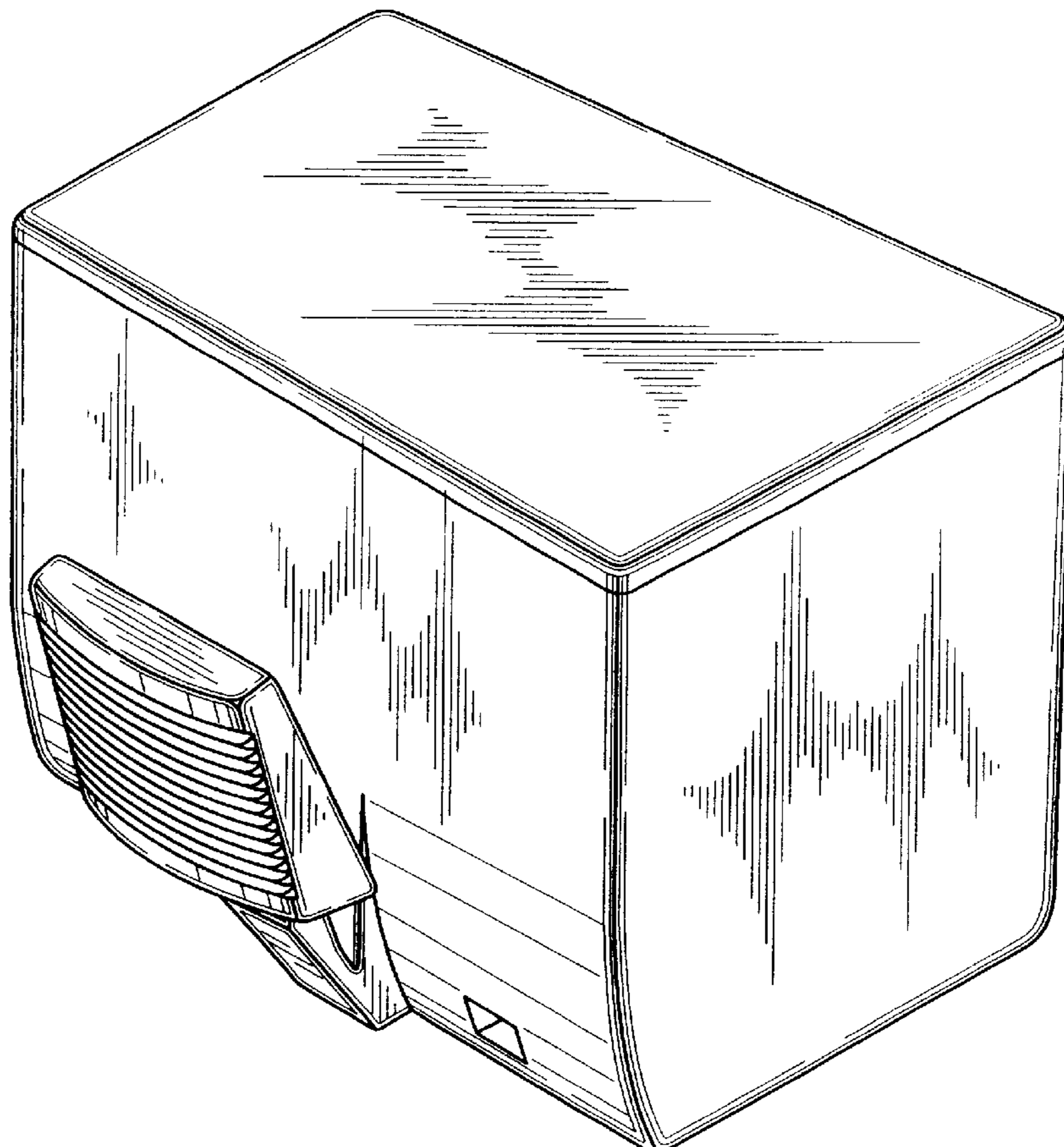

FIG. 1

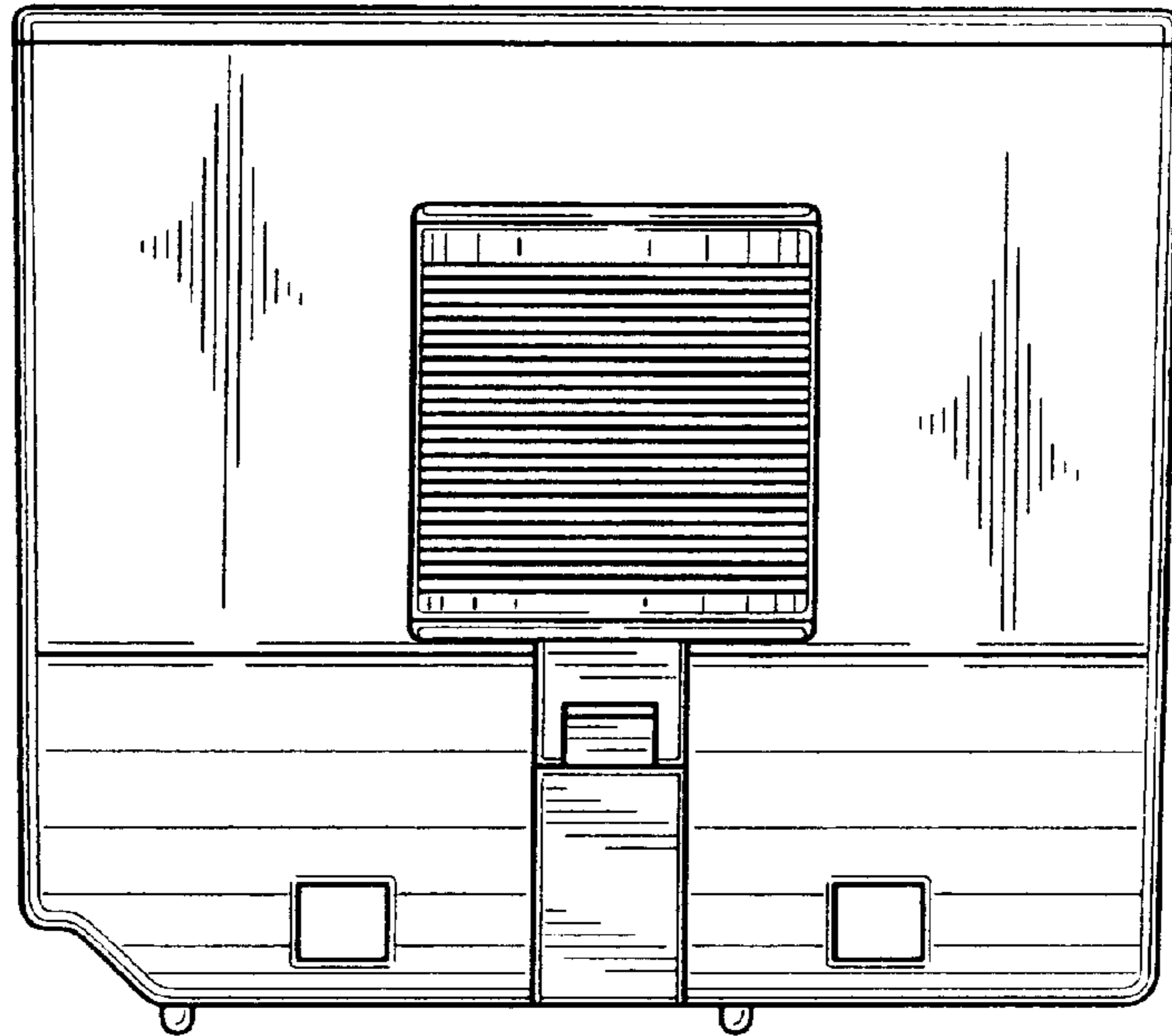

FIG. 2

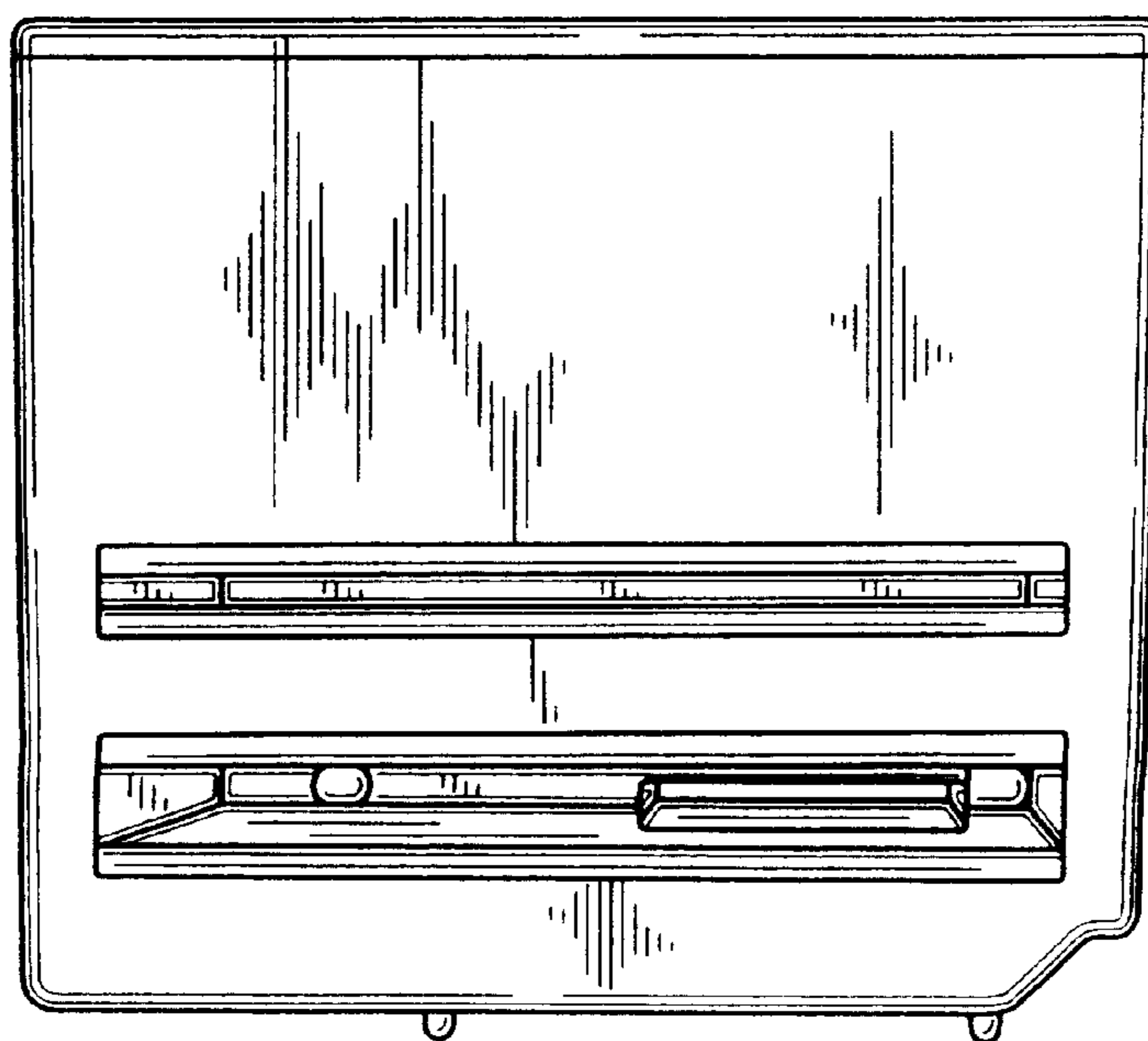

FIG. 3

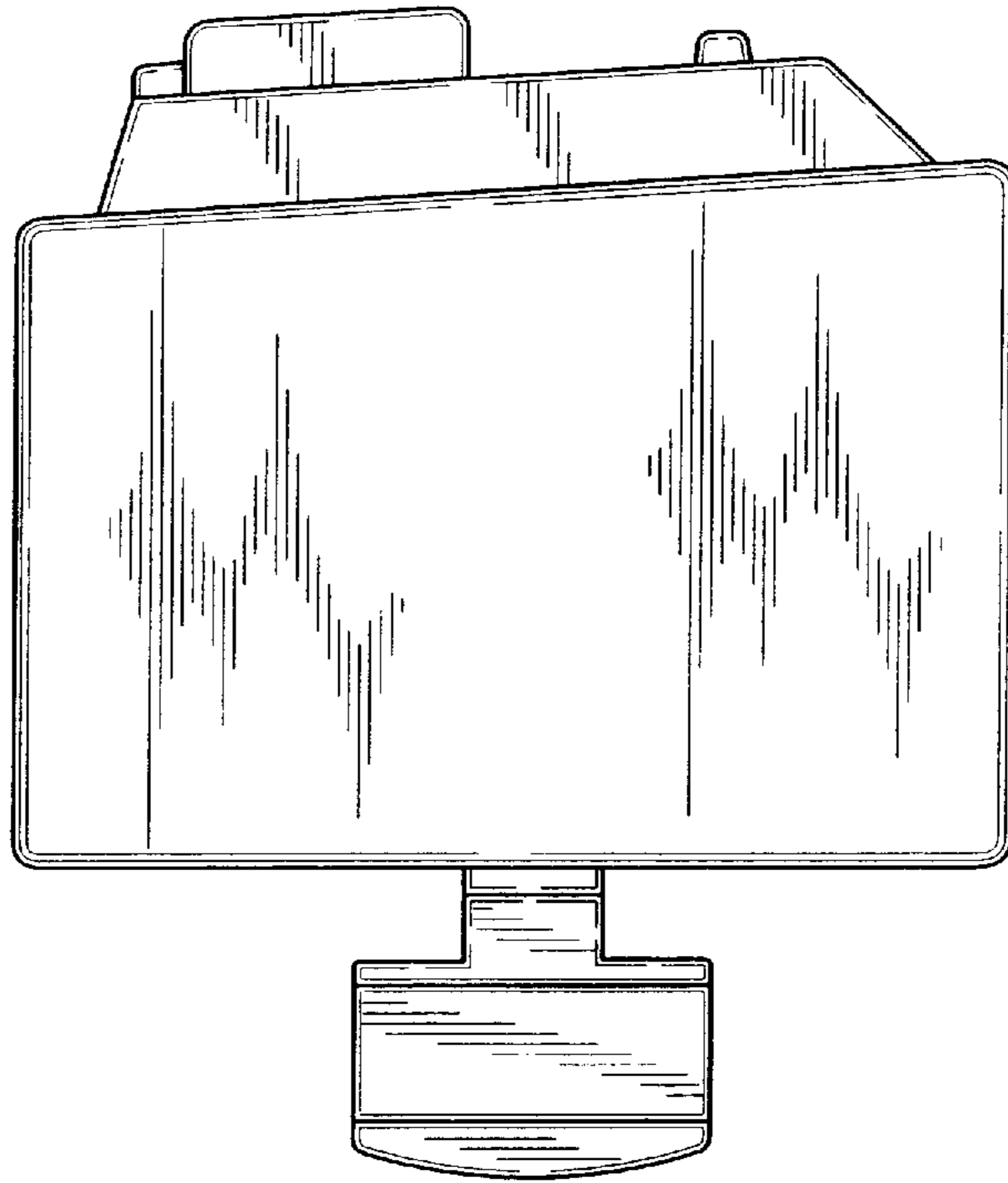

FIG. 4

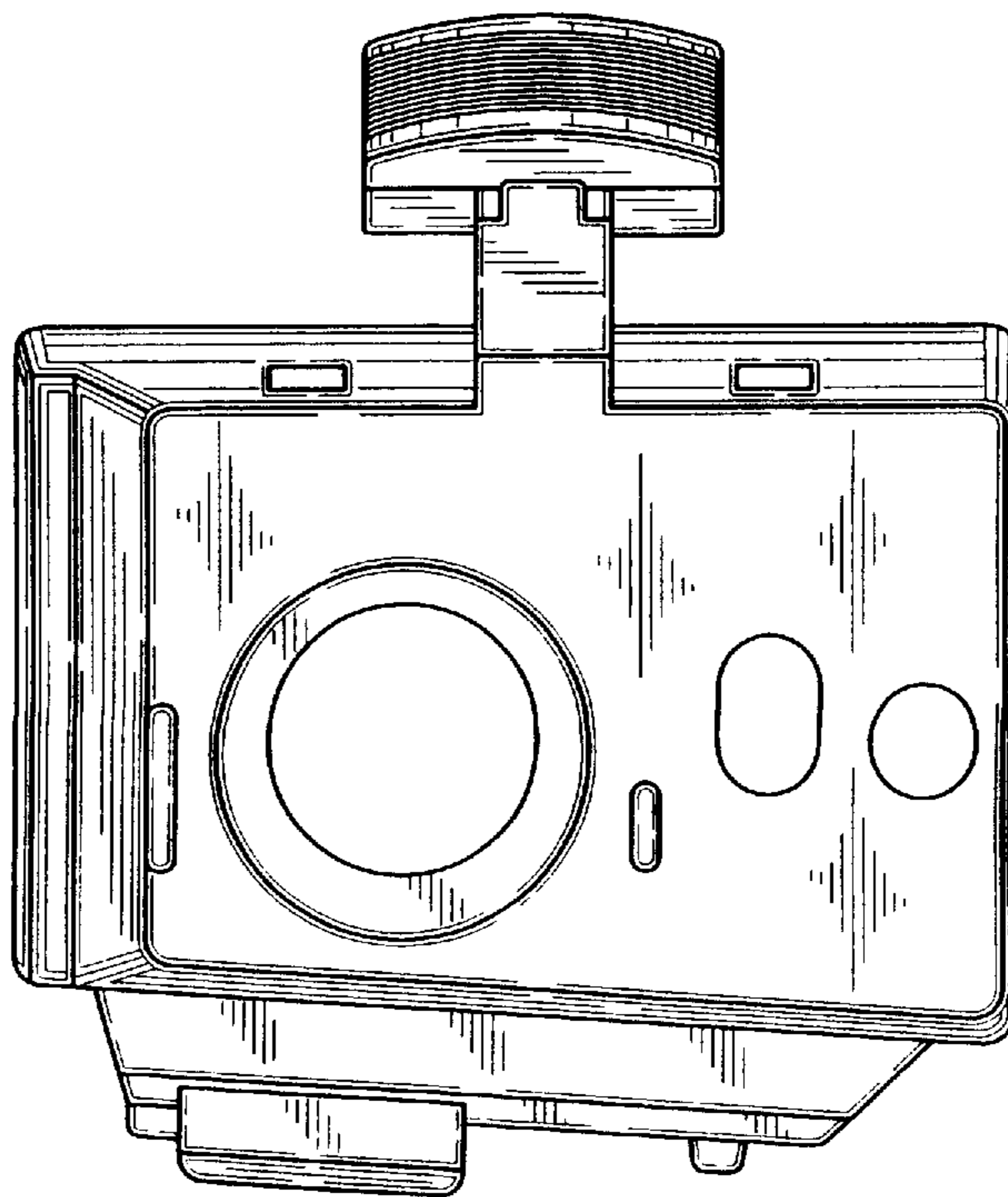

FIG. 5

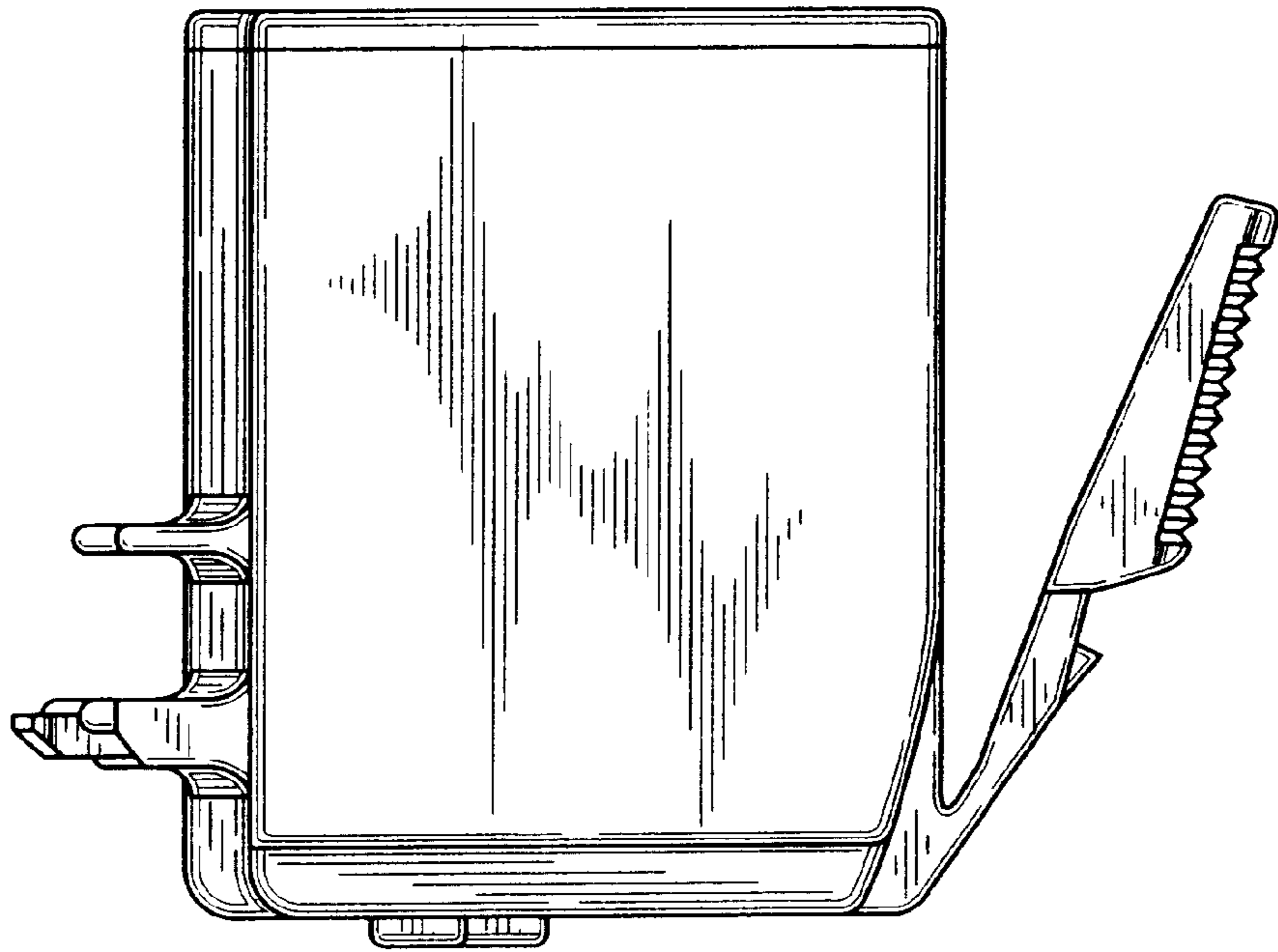

FIG. 6

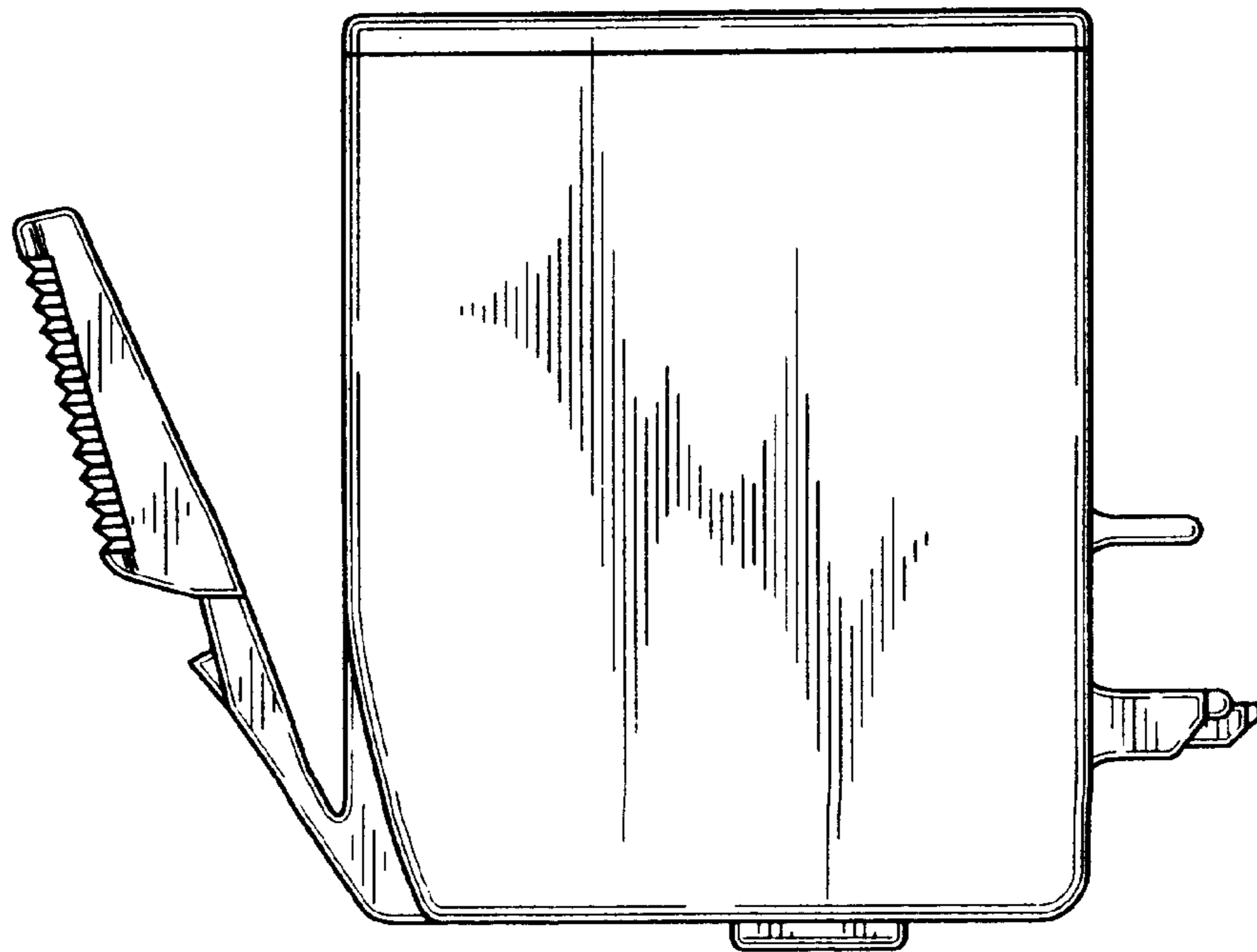

FIG. 7

