



US00D436093S

(12) United States Design Patent
Okada et al.

(10) Patent No.: US D436,093 S

(45) Date of Patent: ** Jan. 9, 2001

**(54) INTEGRATED MULTIMEDIA
INFORMATION SYSTEM COMBINED WITH
DVD PLAYER**

D. 394,260 * 5/1998 Ito et al. D14/156
5,650,891 * 7/1997 Thayne et al. 369/77.2

FOREIGN PATENT DOCUMENTS

(75) Inventors: Shimon Okada; Tsutomu Kamimura,
both of Tokyo (JP)

934600 9/1995 (JP) .
935691 9/1995 (JP) .

(73) Assignee: Mitsubishi Denki Kabushiki Kaisha,
Tokyo (JP)

* cited by examiner

() Term: 14 Years**

Primary Examiner—Nanda Bondade
(74) Attorney, Agent, or Firm—Oblon, Spivak, McClelland,
Maier & Neustadt, P.C.

(21) Appl. No.: 29/111,643

(57) CLAIM

(22) Filed: Oct. 4, 1999

The ornamental design for an integrated multimedia infor-
mation system combined with DVD player, as shown.

(30) Foreign Application Priority Data

DESCRIPTION

Apr. 26, 1999 (JP) 11-11007

(51) LOC (7) Cl. 14-01

(52) U.S. Cl. D14/168; D14/156

(58) Field of Search D14/135, 136,
D14/156, 157, 160, 167-168, 197-198,
257, 258; 369/75.1, 75.2, 77.1, 77.2

FIG. 1 is a front, top and right side perspective view of an
integrated multimedia information system combined with
DVD player, showing our new design;
FIG. 2 is a front elevational view thereof;
FIG. 3 is a top plan view thereof;
FIG. 4 is a rear elevational view thereof;
FIG. 5 is a bottom plan view thereof;
FIG. 6 is a right side elevational view thereof;
FIG. 7 is a left side elevational view thereof; and,
FIG. 8 is an enlarged cross-sectional view thereof, taken
along line 8-8 of FIG. 2, with the internal system omitted.

(56) References Cited

U.S. PATENT DOCUMENTS

D. 279,000 * 5/1985 Sarges D14/157
D. 340,716 * 10/1993 Ito et al. D14/156
D. 391,958 * 3/1998 Miyazawa et al. D14/156

1 Claim, 5 Drawing Sheets

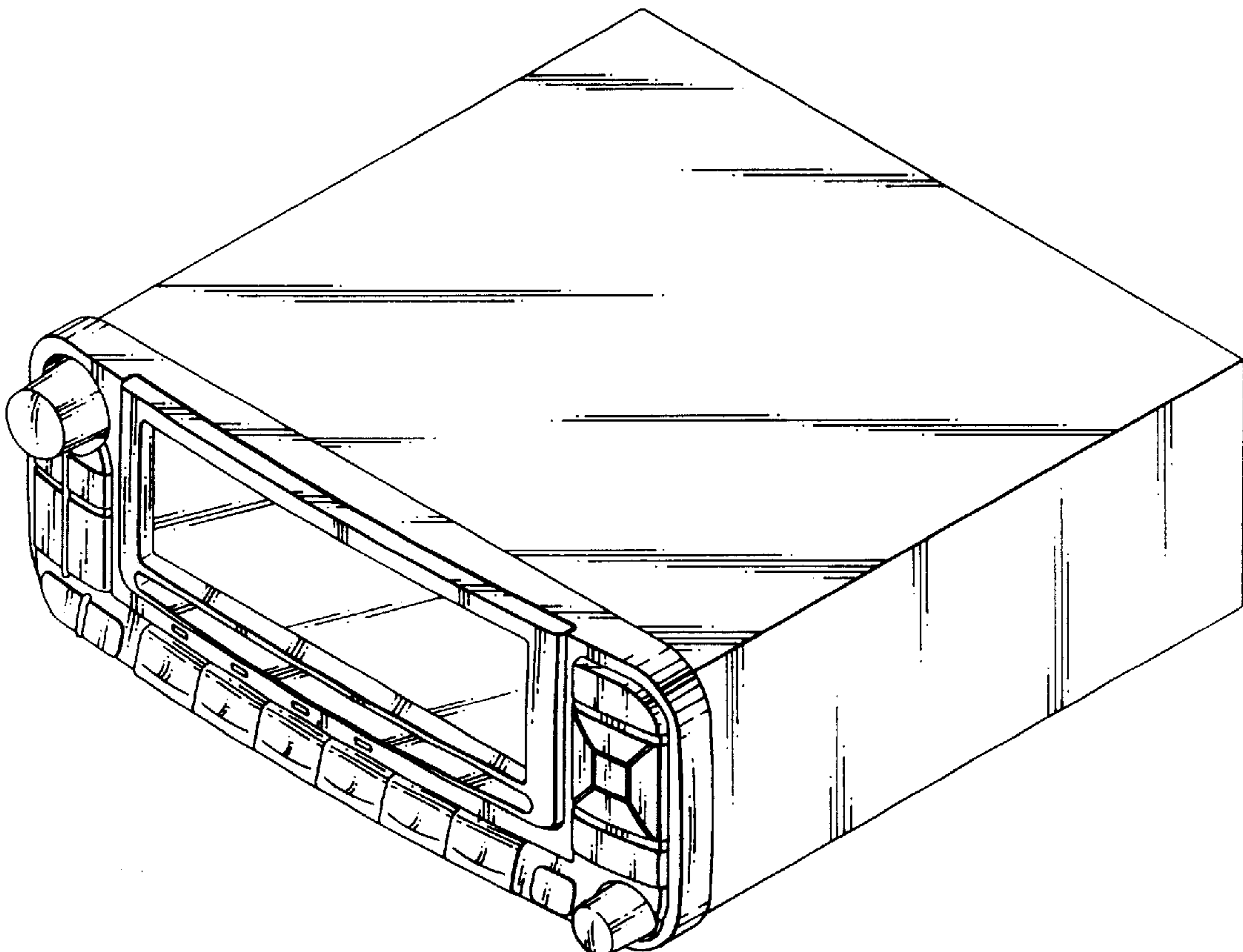

FIG. 1

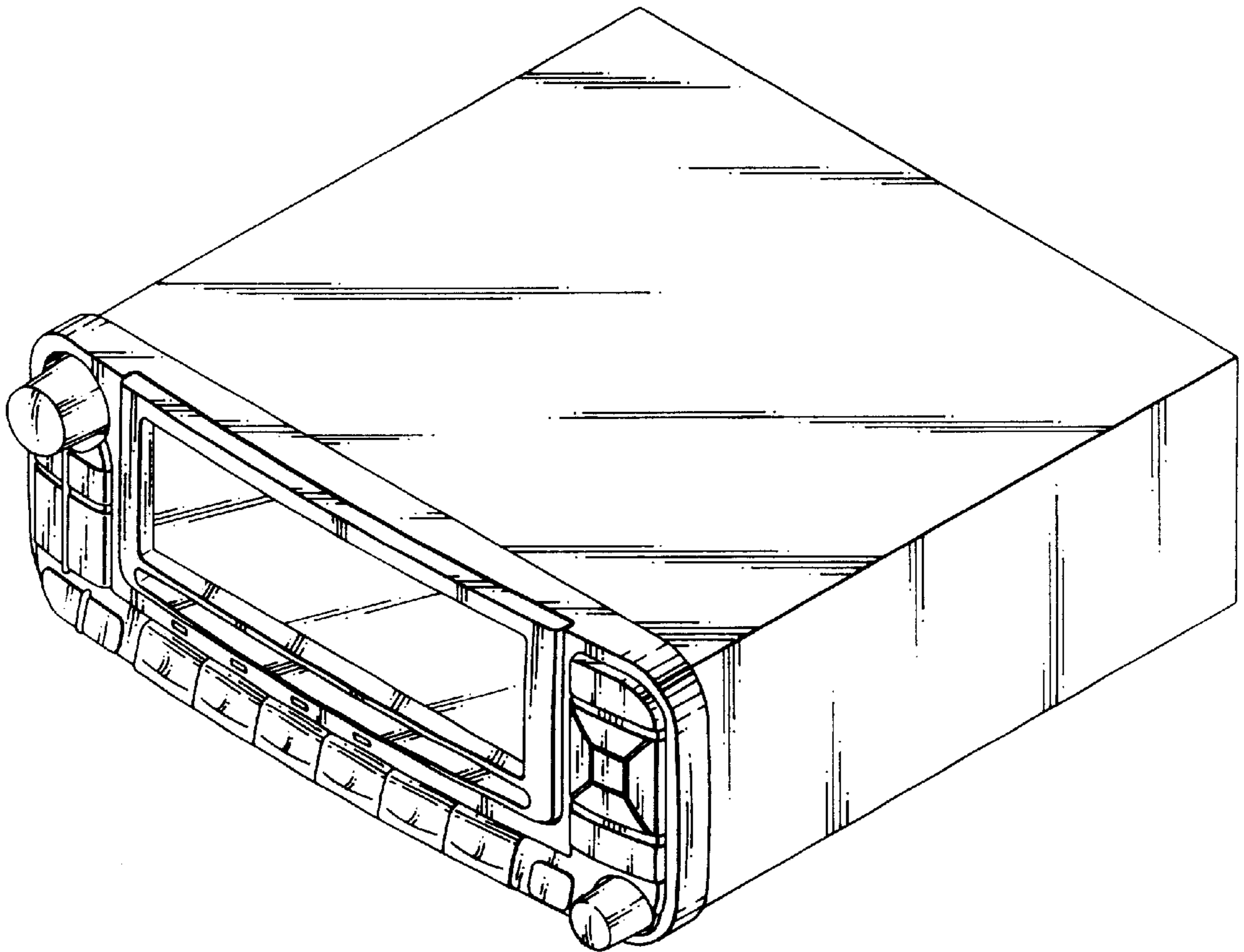

FIG. 2

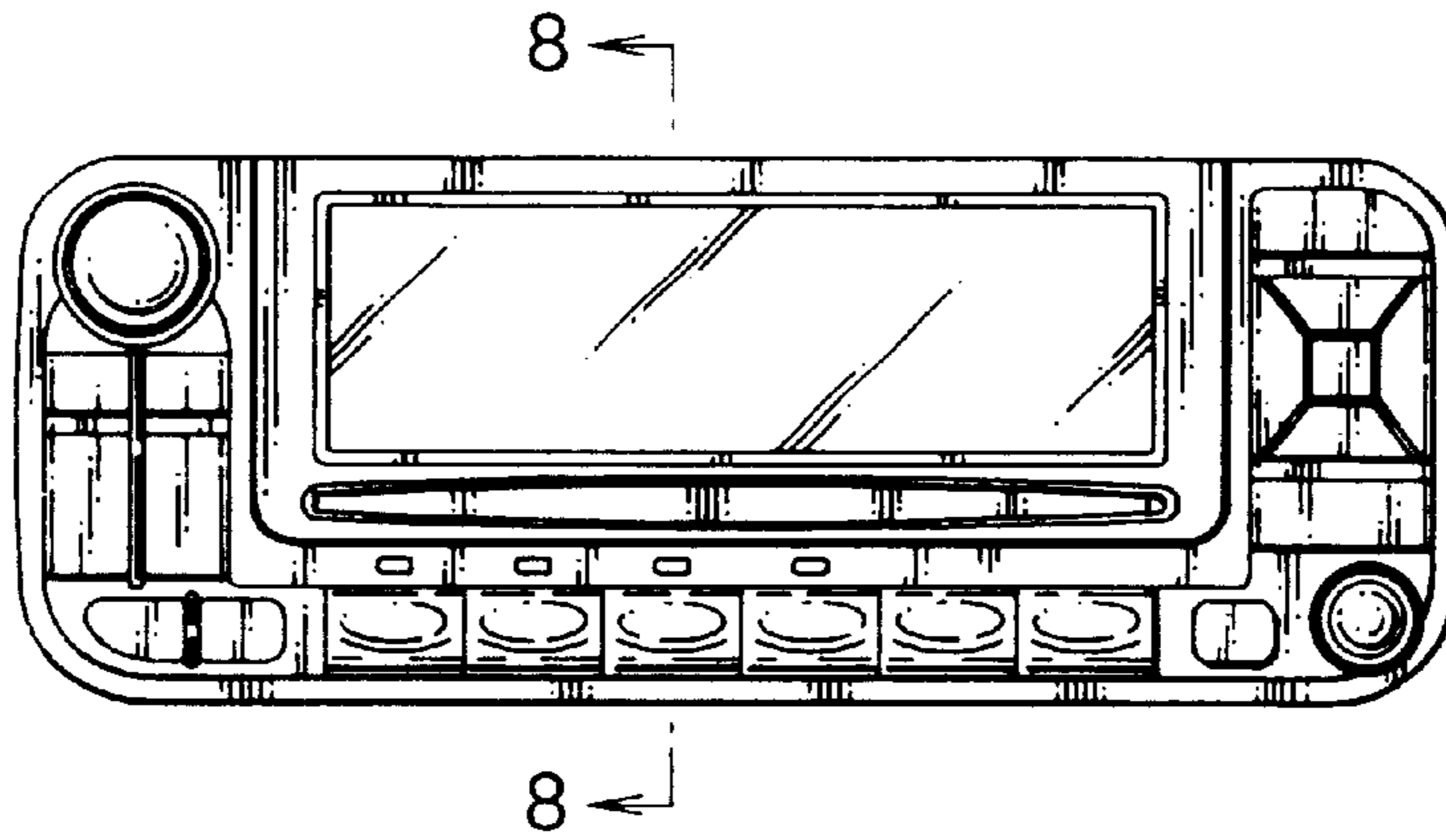

FIG. 3

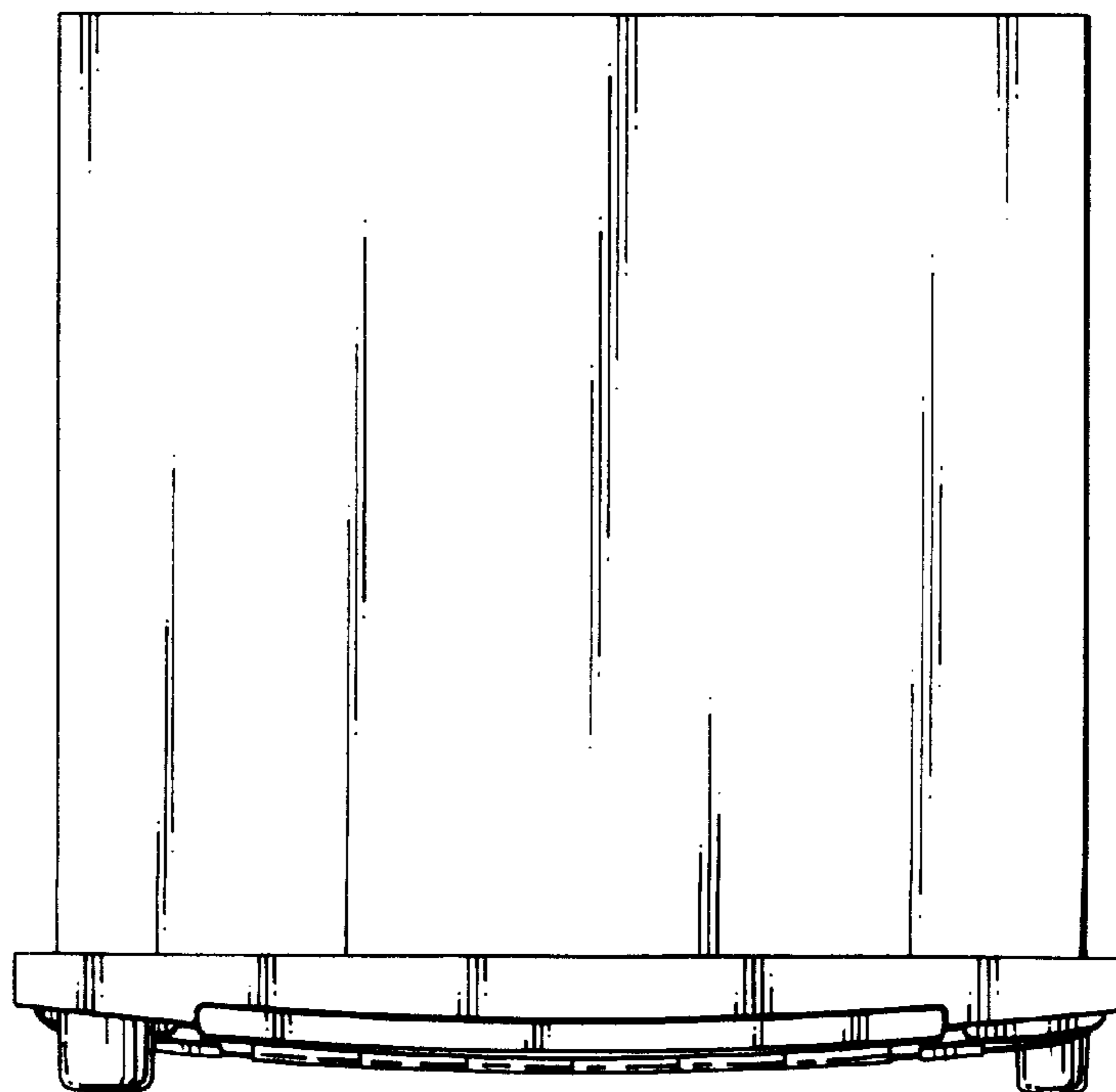

FIG. 4

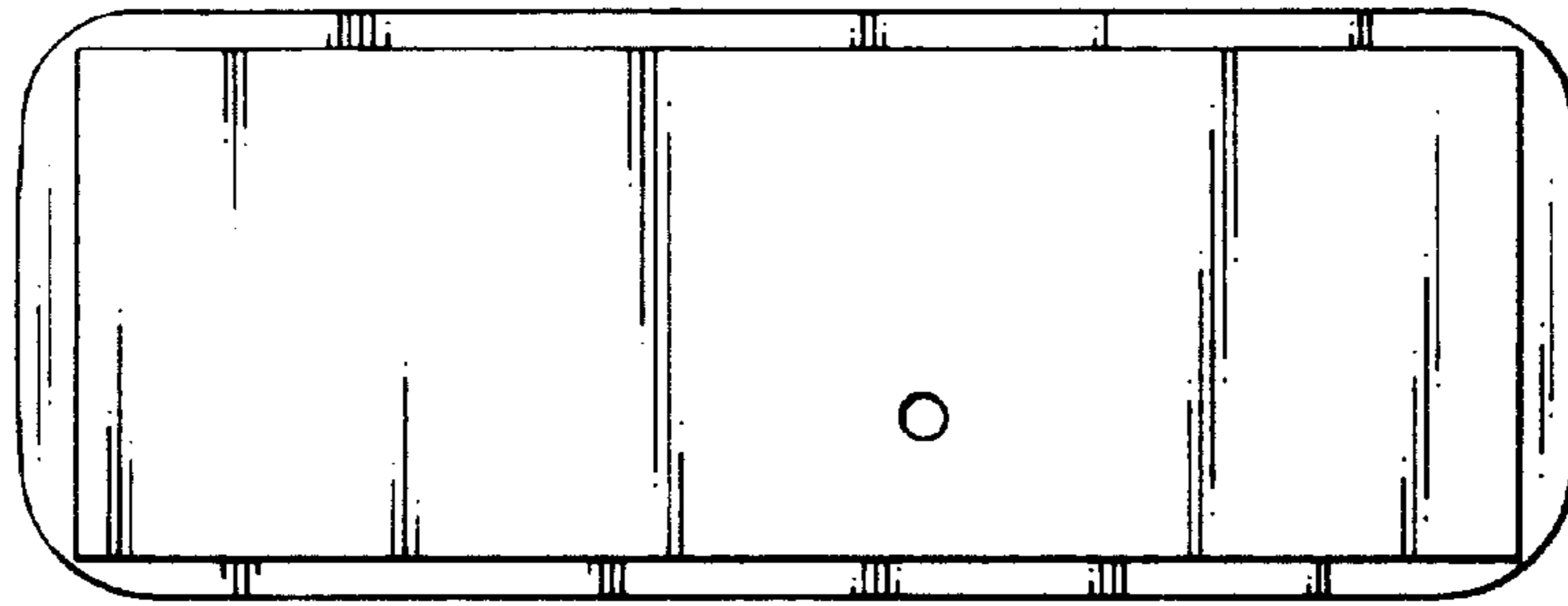

FIG. 5

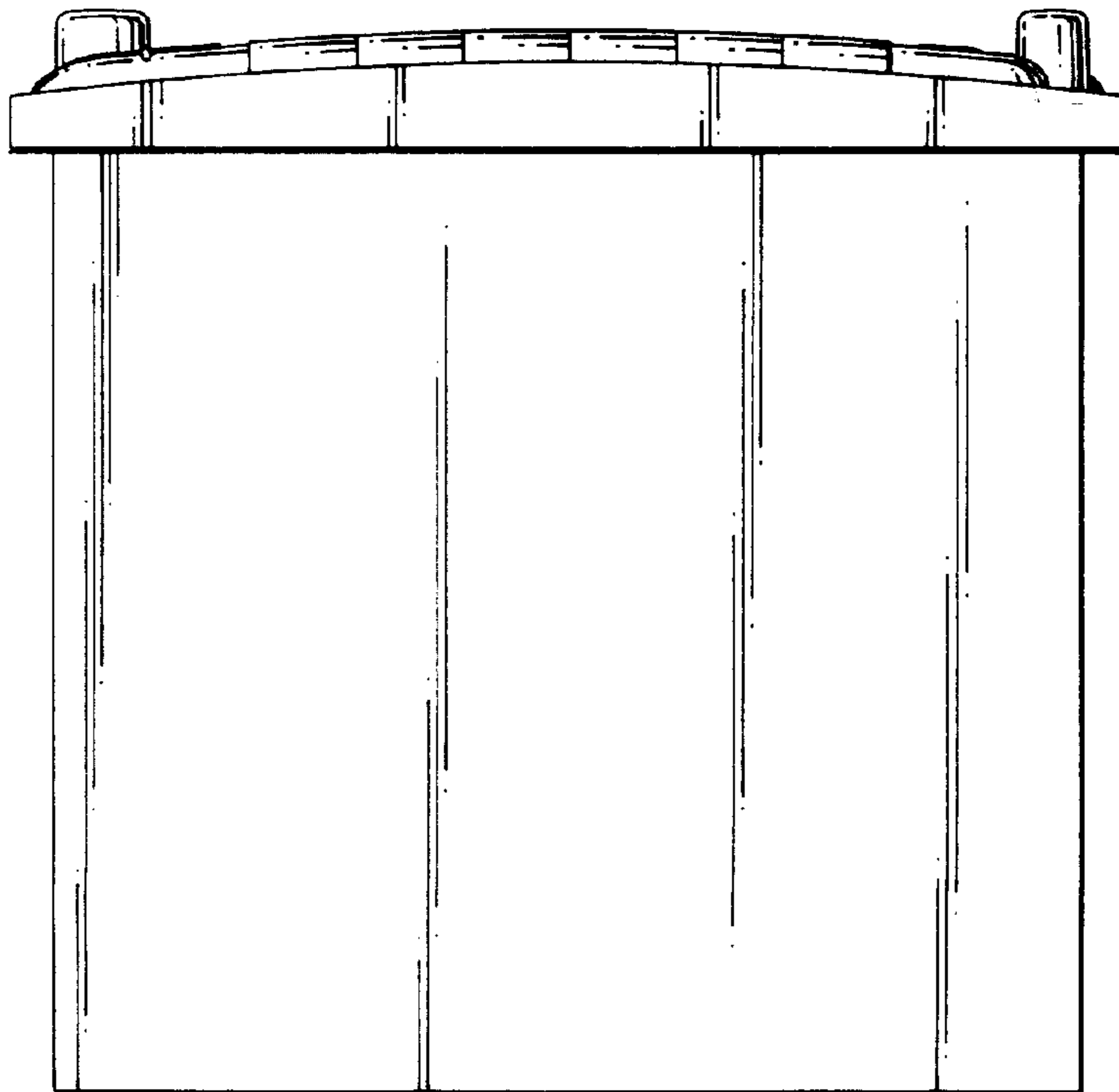

FIG. 6

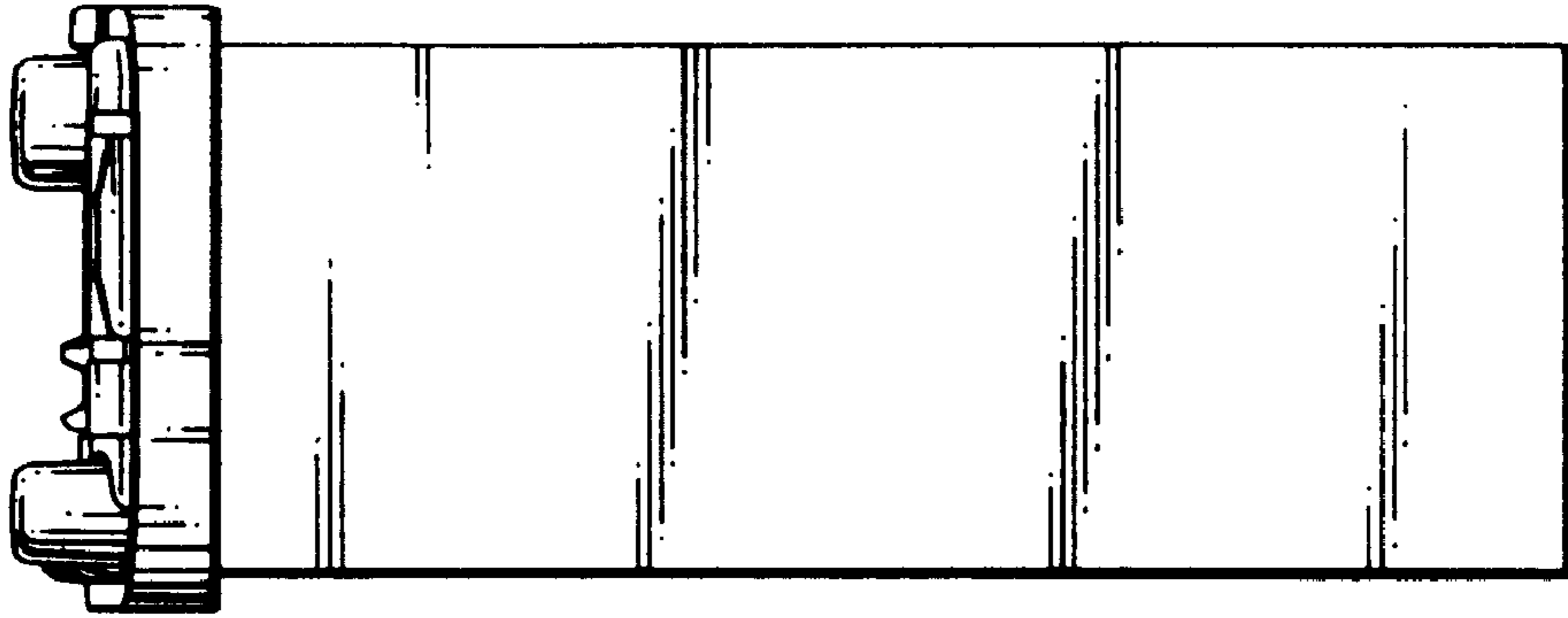

FIG. 7

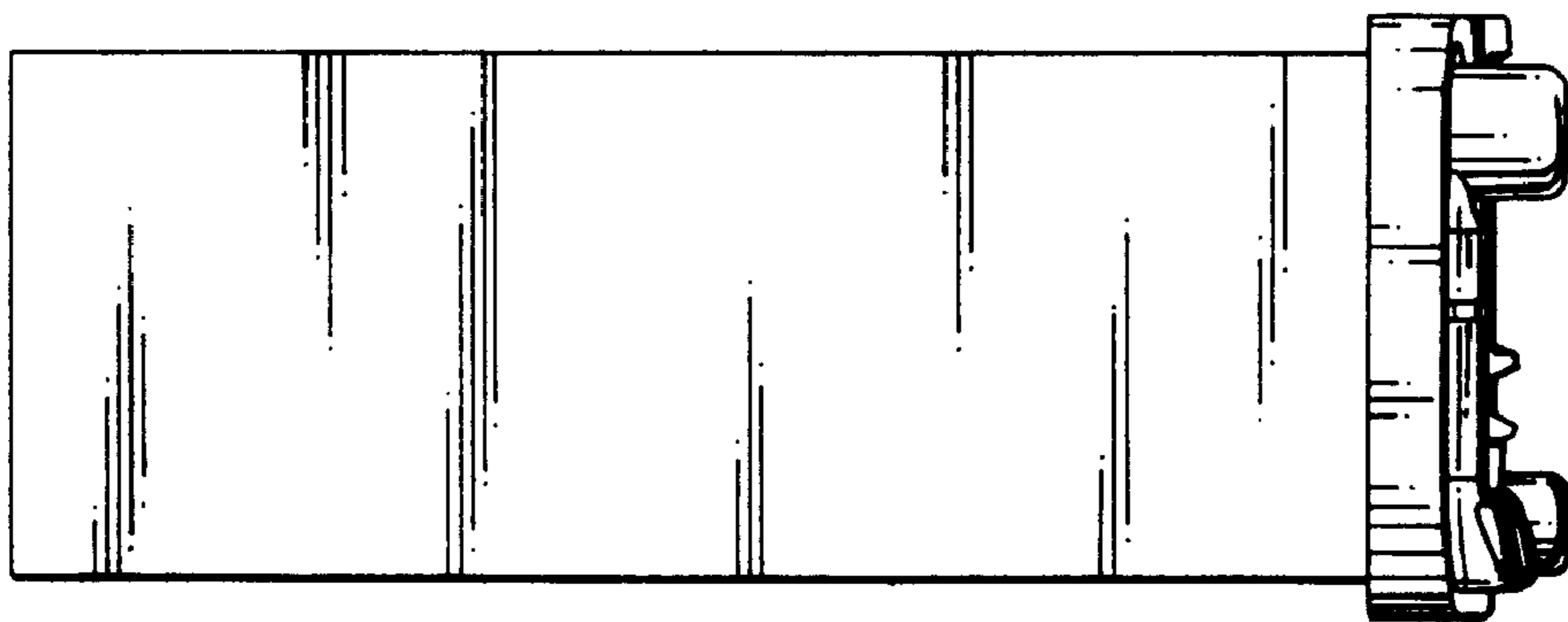

FIG. 8

