



US00D436012S

(12) **United States Design Patent**  
**Lavigne et al.**

(10) **Patent No.:** **US D436,012 S**

(45) **Date of Patent:** **\*\* Jan. 9, 2001**

(54) **MACHINING VISE HAVING A PIVOTAL JAW ASSEMBLY**

(75) Inventors: **Gerard E. Lavigne; Michael R. Corriveau**, both of Coventry; **Gregory A. Armstrong**, West Warwick, all of RI (US)

(73) Assignee: **Lavigne Manufacturing, Inc.**, Cranston, RI (US)

(\*\*) Term: **14 Years**

(21) Appl. No.: **29/116,349**

(22) Filed: **Dec. 30, 1999**

**Related U.S. Application Data**

(62) Division of application No. 29/099,069, filed on Jan. 12, 1999, now Pat. No. Des. 420,880.

(51) **LOC (7) Cl.** ..... **08-05**

(52) **U.S. Cl.** ..... **D8/74**

(58) **Field of Search** ..... D8/71, 72, 73, D8/74; D15/140; 269/240, 243, 246, 247, 261

(56) **References Cited**

**U.S. PATENT DOCUMENTS**

D. 234,118 1/1975 Molitors ..... D8/74

D. 254,376	3/1980	Glomb et al. ....	D8/74
D. 287,457	12/1986	Listes .....	D8/74
3,063,707	11/1962	Kelley .	
3,223,407	12/1965	Wills .	
3,397,880	8/1968	Kuban .	
4,070,010	1/1978	Brasca .....	269/27
4,383,682	5/1983	Feinberg .....	269/76
4,863,151	9/1989	Justesen .....	269/261

**OTHER PUBLICATIONS**

Wilton Catalog, Milling Machine Vice, p. 12, 1963.\*

\* cited by examiner

*Primary Examiner*—Philip S. Hyder

(74) *Attorney, Agent, or Firm*—Salter & Michaelson

(57) **CLAIM**

The ornamental design for a machining vise having a pivotal jaw assembly, as shown.

**DESCRIPTION**

FIG. 1 is a perspective view showing our new design; FIG. 2 is a top plan view thereof; FIG. 3 is a bottom plan view thereof; FIG. 4 is a front elevational view thereof; FIG. 5 is a rear elevational view thereof; FIG. 6 is a left end view thereof; and, FIG. 7 is a right end view thereof.

**1 Claim, 4 Drawing Sheets**

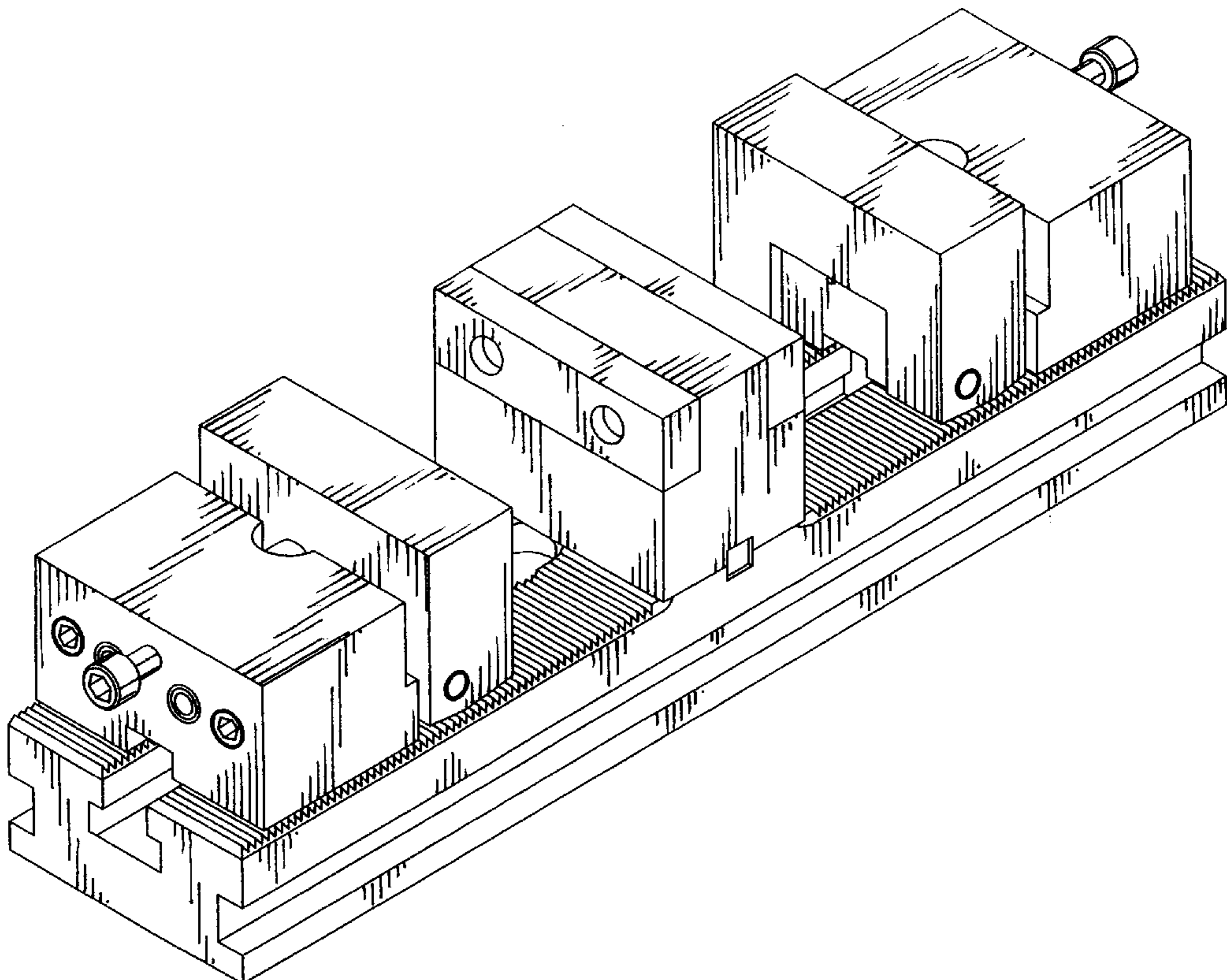

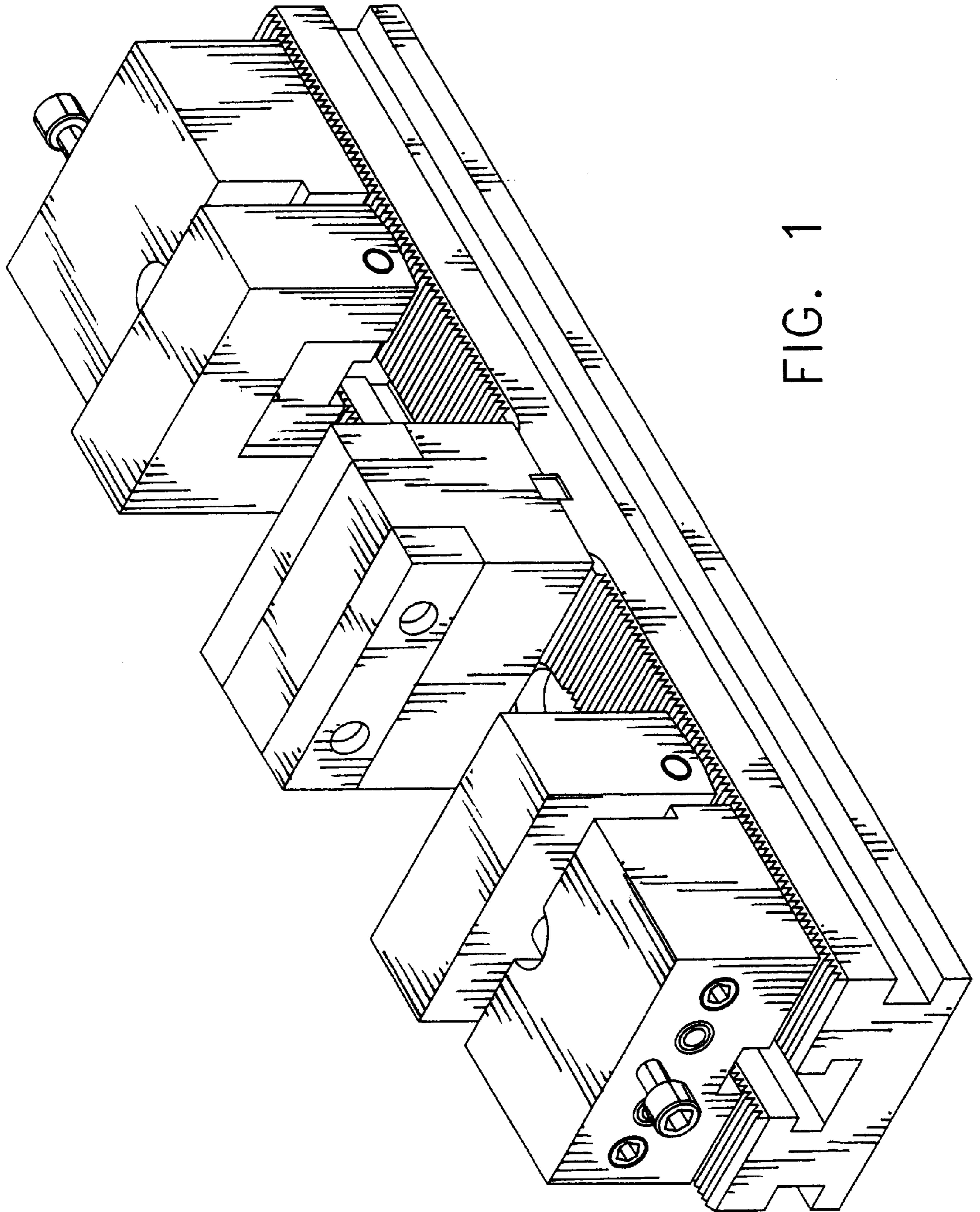

FIG. 1

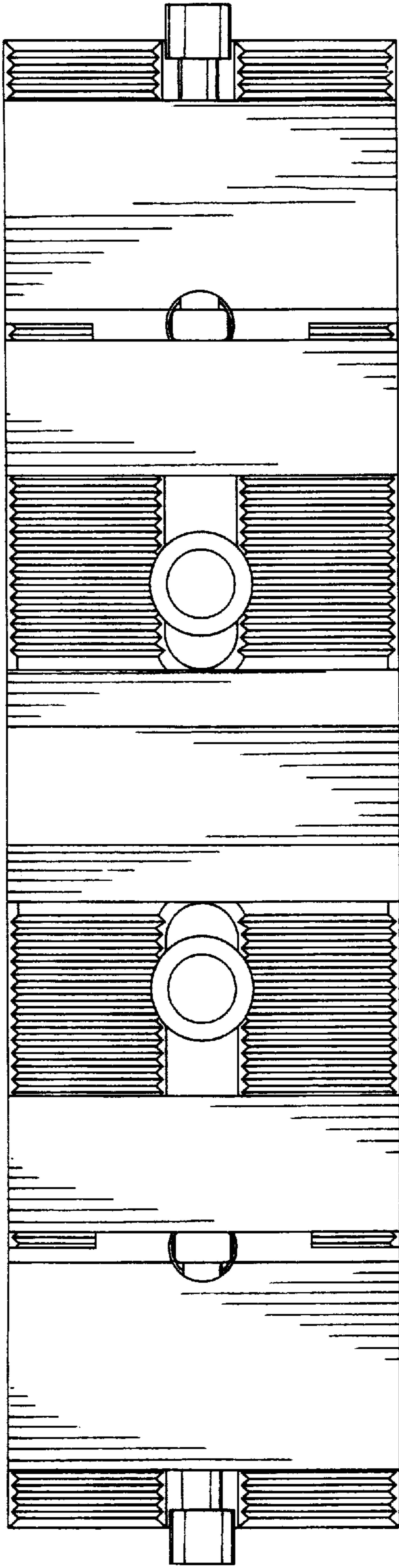

FIG. 2

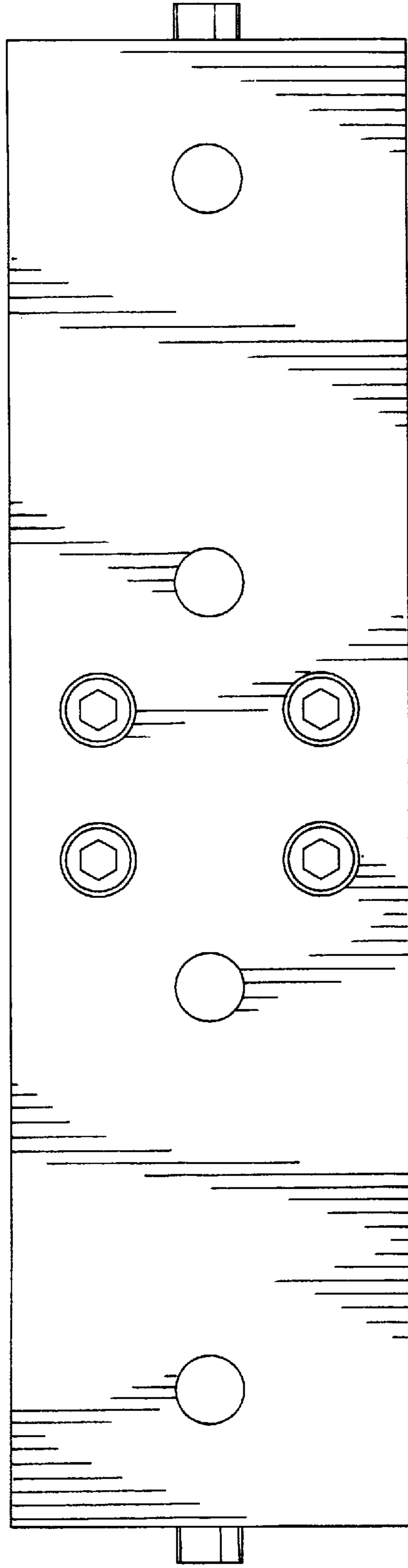

FIG. 3

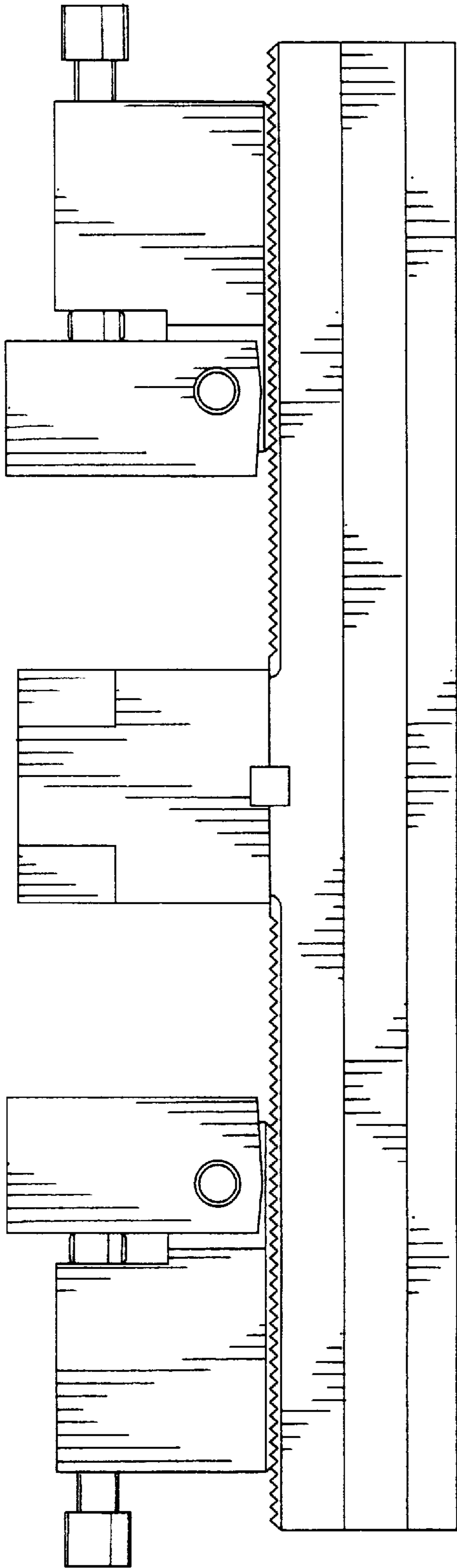

FIG. 4

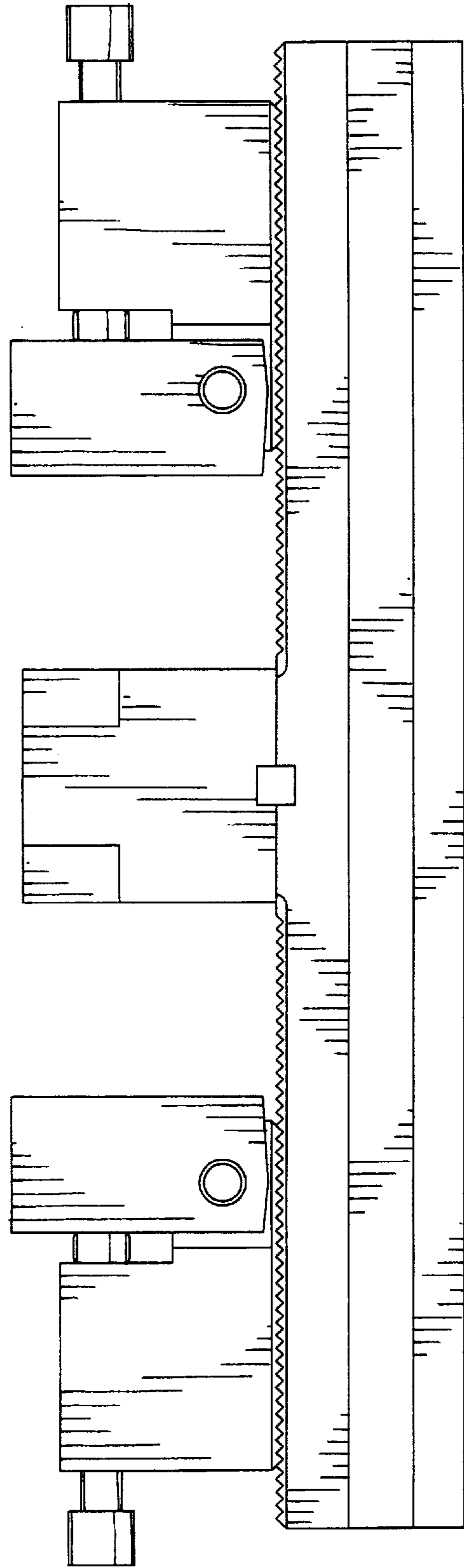

FIG. 5

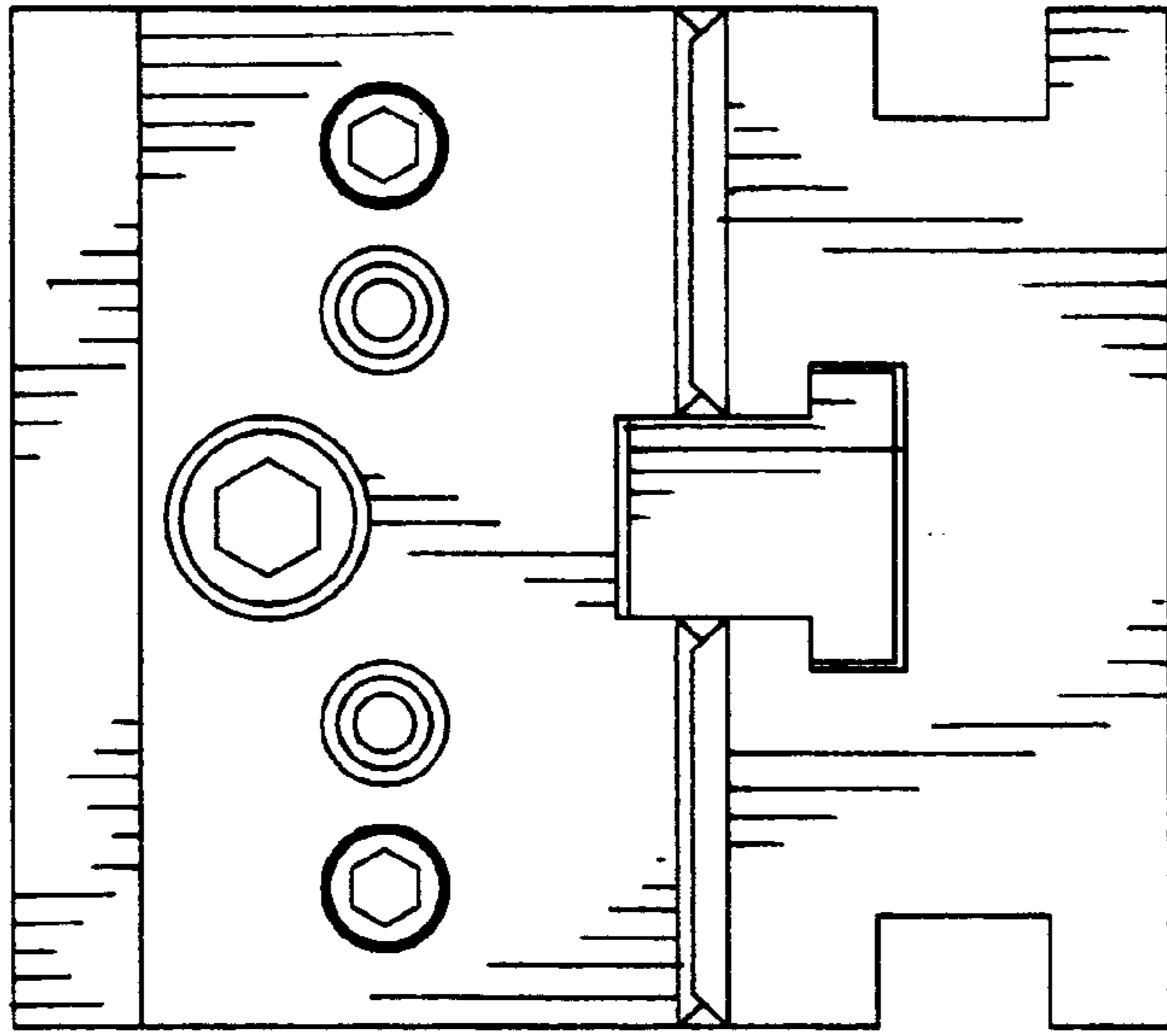

FIG. 6

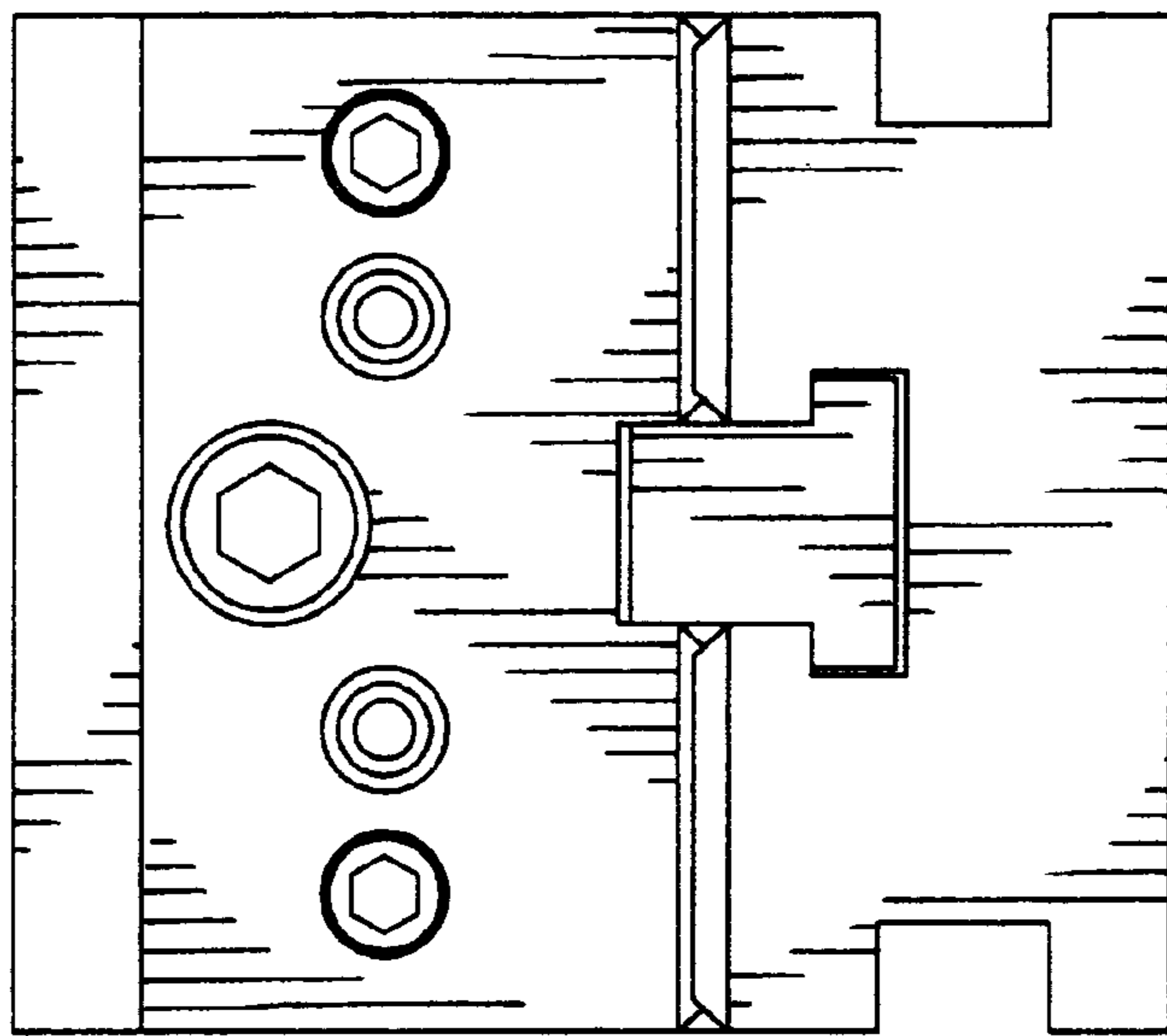

FIG. 7