



US00D435990S

(12) **United States Design Patent**  
**Felsenthal**

(10) **Patent No.:** **US D435,990 S**

(45) **Date of Patent:** **\*\* Jan. 9, 2001**

(54) **HANGING DRAWER SET**

5,542,530 \* 8/1996 Freelandr ..... 206/286 X

(76) Inventor: **Sandy Alan Felsenthal**, 5428  
Collingwood Cove, Memphis, TN (US)  
38120

\* cited by examiner

*Primary Examiner*—Brian N. Vinson

(74) *Attorney, Agent, or Firm*—Peter J. Georges

(\*\*) Term: **14 Years**

(57) **CLAIM**

The ornamental design for a hanging drawer set, as shown and described.

(21) Appl. No.: **29/117,317**

**DESCRIPTION**

(22) Filed: **Jan. 24, 2000**

The claimed hanging drawer set is adapted for hanging from closet rods for storage of clothing, footwear, jewelry, papers and the like.

(51) **LOC (7) Cl.** ..... **06-06**

(52) **U.S. Cl.** ..... **D6/514**

(58) **Field of Search** ..... D6/512–514, 553,  
D6/567; 206/278, 8, 280, 286, 287, 527;  
211/113, 118, 126.2

FIG. 1 is a front elevational view of a hanging drawer set showing my new design;

FIG. 2 is a rear elevational view thereof;

FIG. 3 is a side elevational view thereof, the broken-line disclosure of a hanging element being for illustrative purposes only and forming no part of the claimed design;

FIG. 4 is a top elevational view thereof;

FIG. 5 is a bottom elevational view thereof;

FIG. 6 is a partial enlarged perspective view thereof; and,

FIG. 7 is a partial enlarged perspective view thereof with bottom drawers removed.

(56) **References Cited**

**U.S. PATENT DOCUMENTS**

- D. 382,747 \* 8/1997 Dickinson et al. .... D6/514
- D. 390,011 \* 2/1998 Turner ..... D6/513 X
- 4,595,106 \* 6/1986 Kunze et al. .... 211/118
- 4,765,495 \* 8/1988 Bisk ..... 211/113
- 5,191,985 \* 3/1993 Licari ..... 211/126.2 X

**1 Claim, 4 Drawing Sheets**

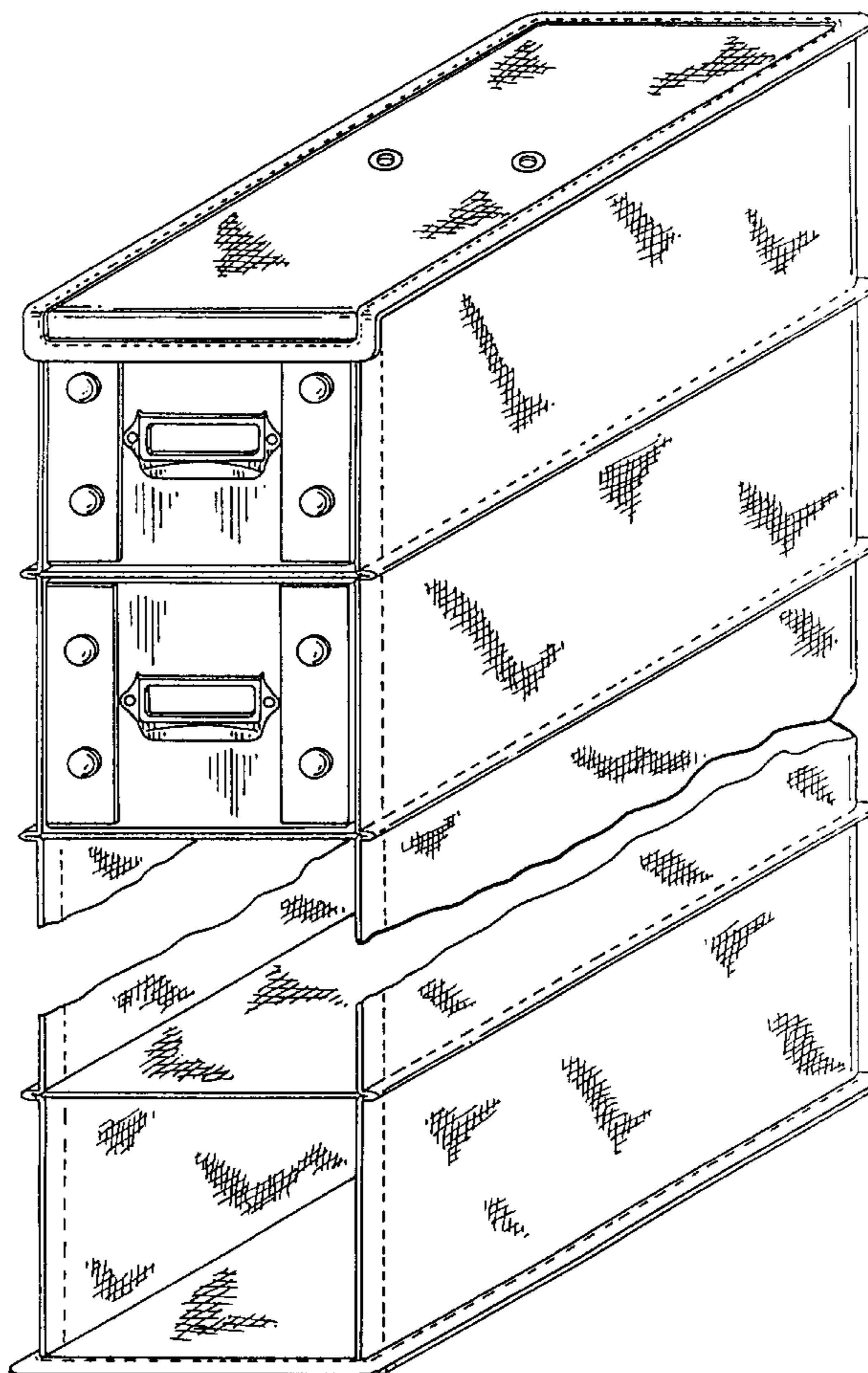

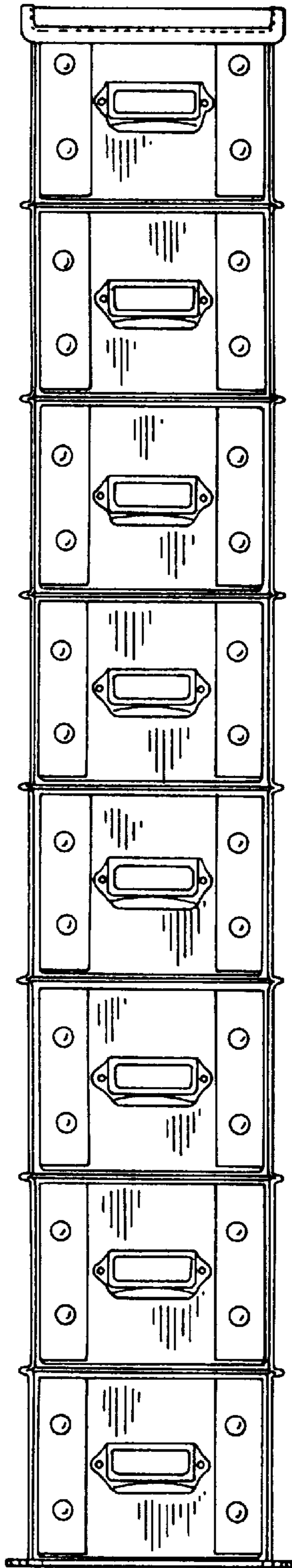

Fig. 1

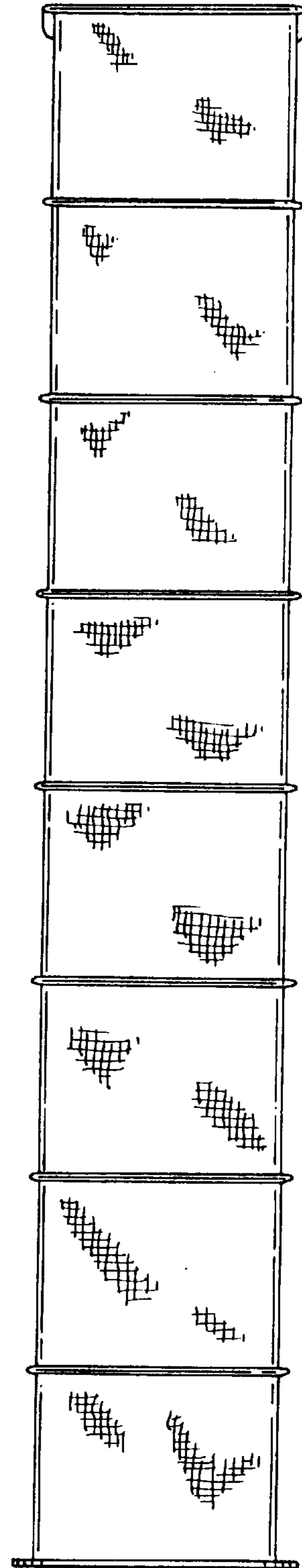

Fig. 2

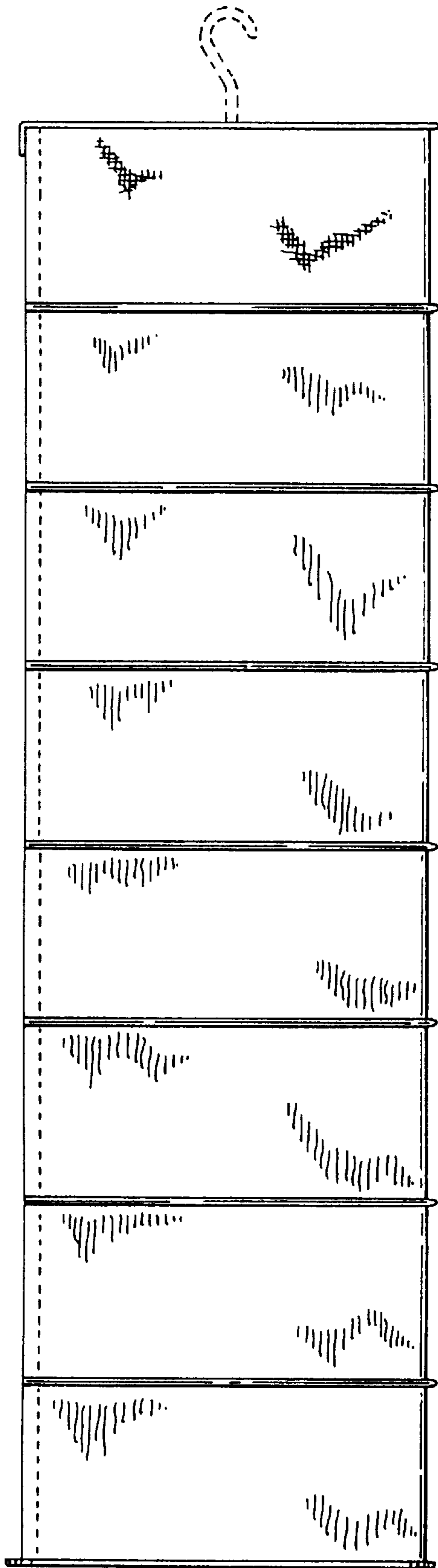

Fig. 3

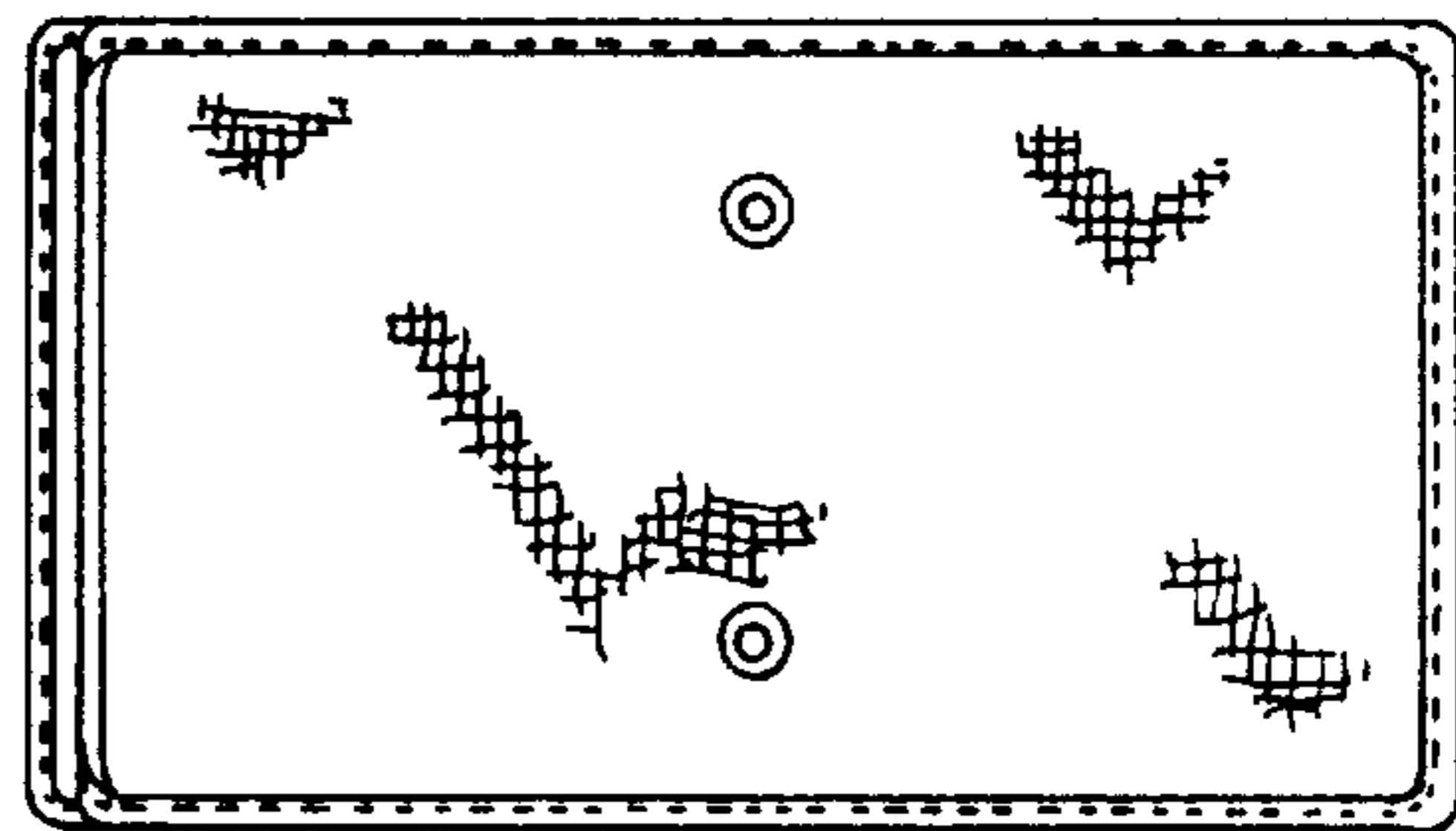

Fig. 4

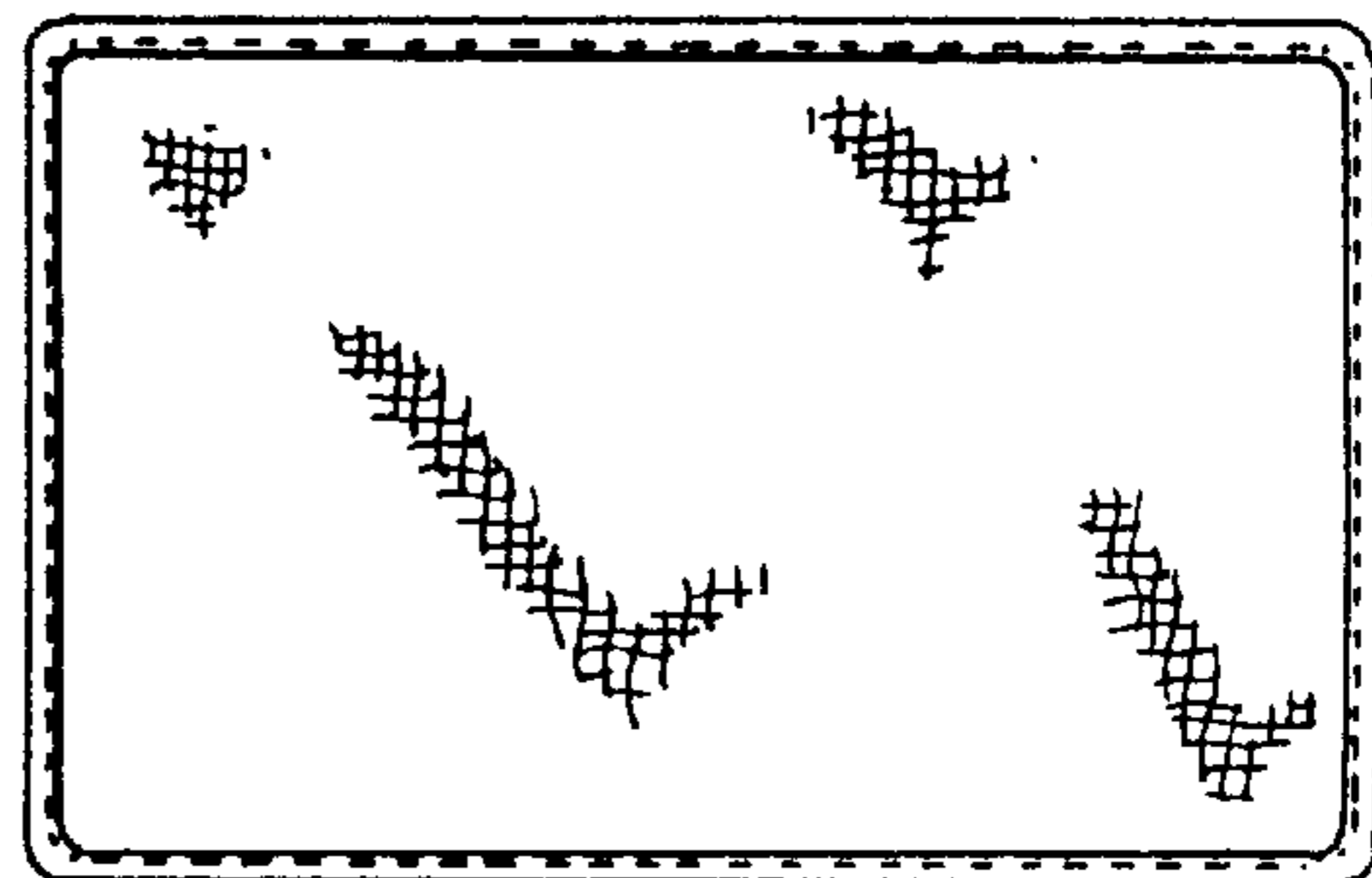

Fig. 5

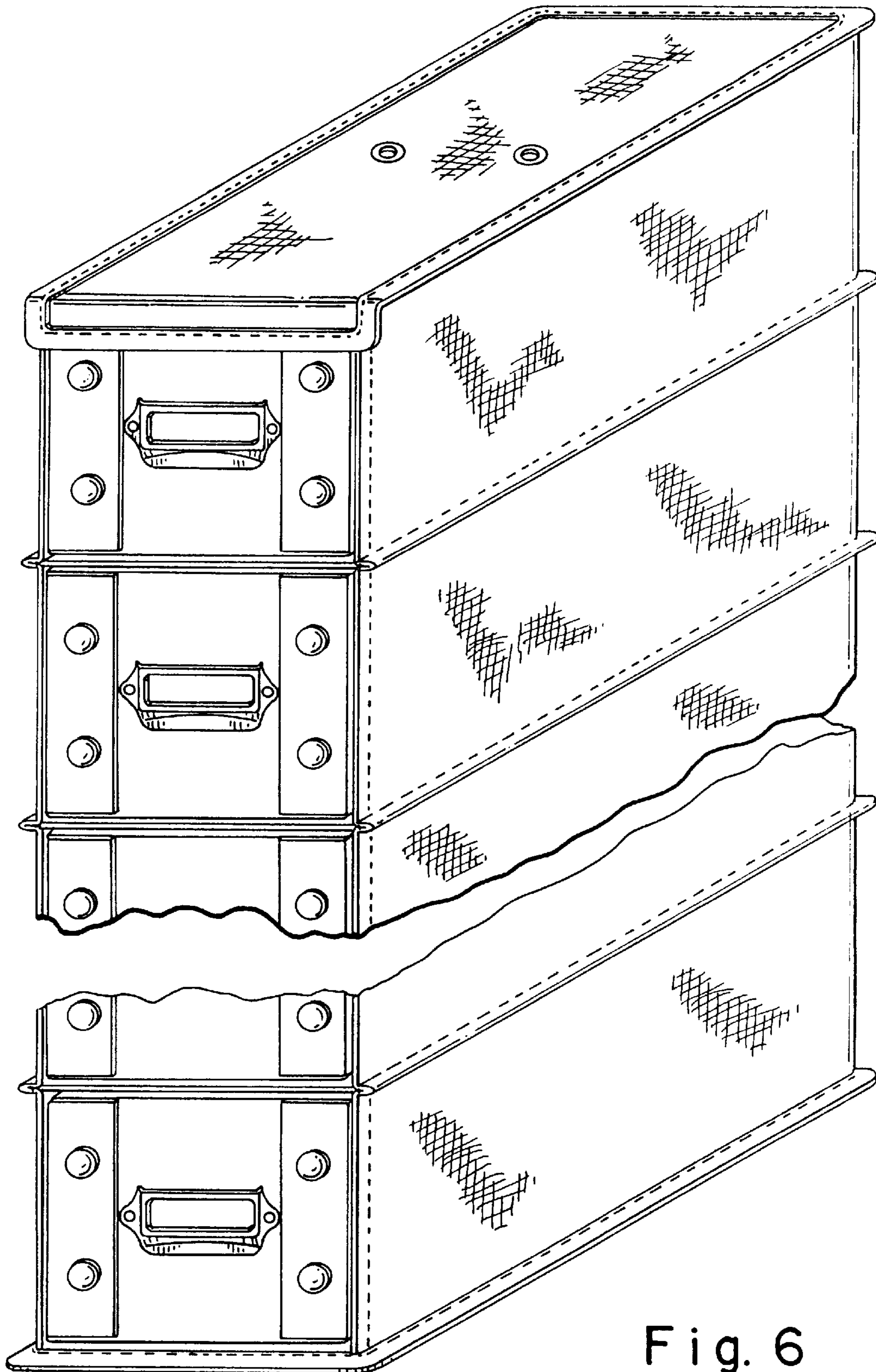

Fig. 6

Fig. 7

