



US00D435988S

(12) **United States Design Patent**
Draheim et al.

(10) **Patent No.:** **US D435,988 S**

(45) **Date of Patent:** **** Jan. 9, 2001**

(54) **HUTCH**

6,079,804 * 6/2000 Draheim 312/107

(75) Inventors: **Harvey J. Draheim**, Weyauwega; **Scott A. Krueger**, Appleton, both of WI (US)

* cited by examiner

(73) Assignee: **Simmons Juvenile Products Company, Inc.**, New London, WI (US)

Primary Examiner—Cathron B. Matta

(74) *Attorney, Agent, or Firm*—Hoffmann & Baron, LLP

(**) Term: **14 Years**

(57) **CLAIM**

The ornamental design for a hutch, as shown and described.

(21) Appl. No.: **29/122,834**

DESCRIPTION

(22) Filed: **May 4, 2000**

(51) **LOC (7) Cl.** **06-04**

(52) **U.S. Cl.** **D6/509; D6/438; D6/477**

(58) **Field of Search** D6/436, 438, 477,
D6/478, 479, 509, 511; 108/50.11, 59, 180;
312/204, 237

FIG. 1 is a top perspective view of a hutch showing our new design;

FIG. 2 is a top plan view thereof;

FIG. 3 is a front elevation view thereof;

FIG. 4 is a side elevation view thereof;

FIG. 5 is a side elevation view thereof opposite from the side shown in FIG. 4; and,

FIG. 6 is an enlarged sectional view taken along line 6—6 of FIG. 3.

The bottom and rear views form no part of the claimed design. The subject matter shown in broken lines is for environmental purposes only and forms no part of the claimed design.

(56) **References Cited**

U.S. PATENT DOCUMENTS

- D. 363,834 * 11/1995 Thompson D6/438
- D. 374,573 * 10/1996 Brunner et al. D6/479
- D. 425,333 * 5/2000 Draheim et al. D6/477
- D. 428,281 7/2000 Draheim et al. .

1 Claim, 6 Drawing Sheets

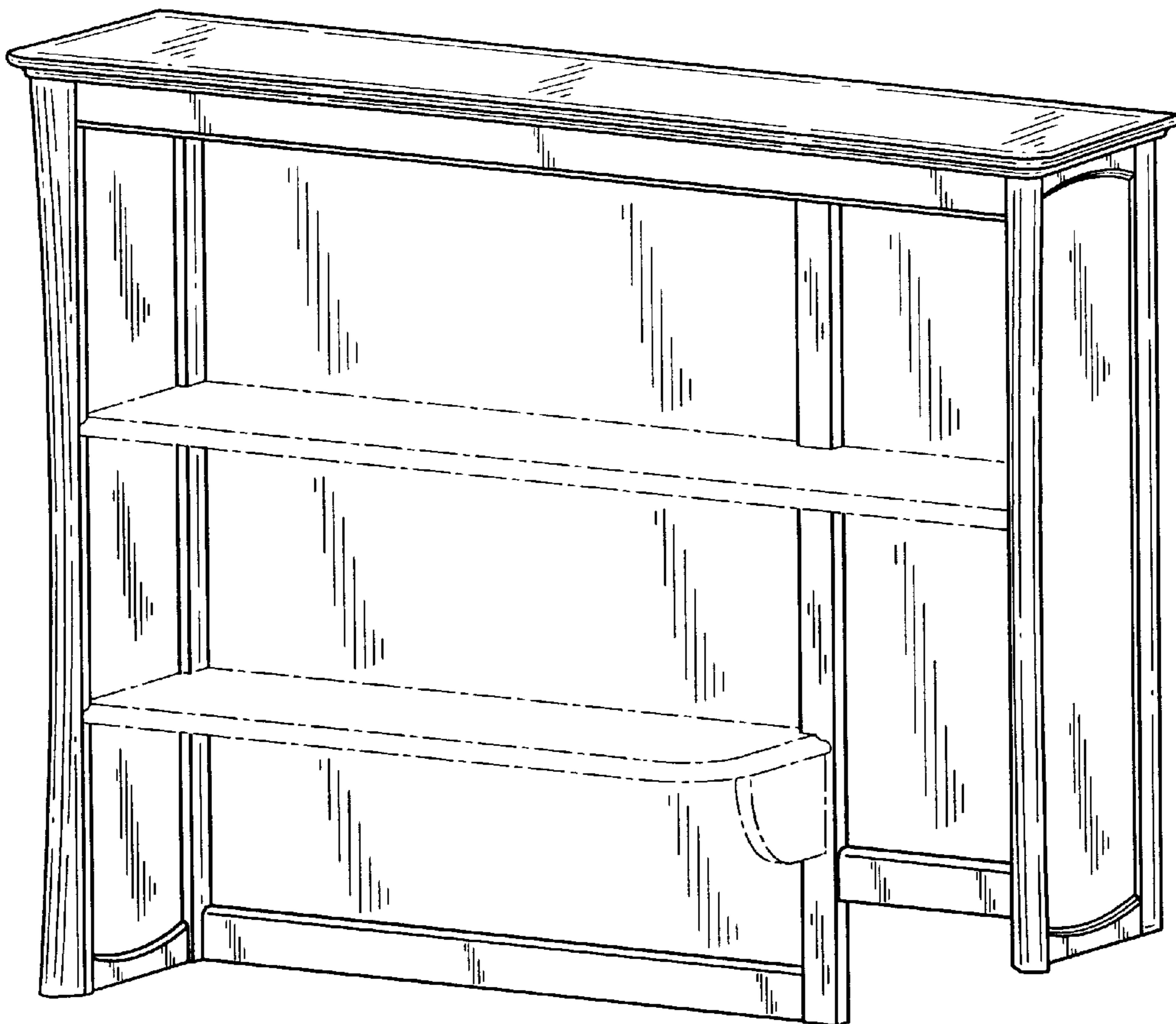

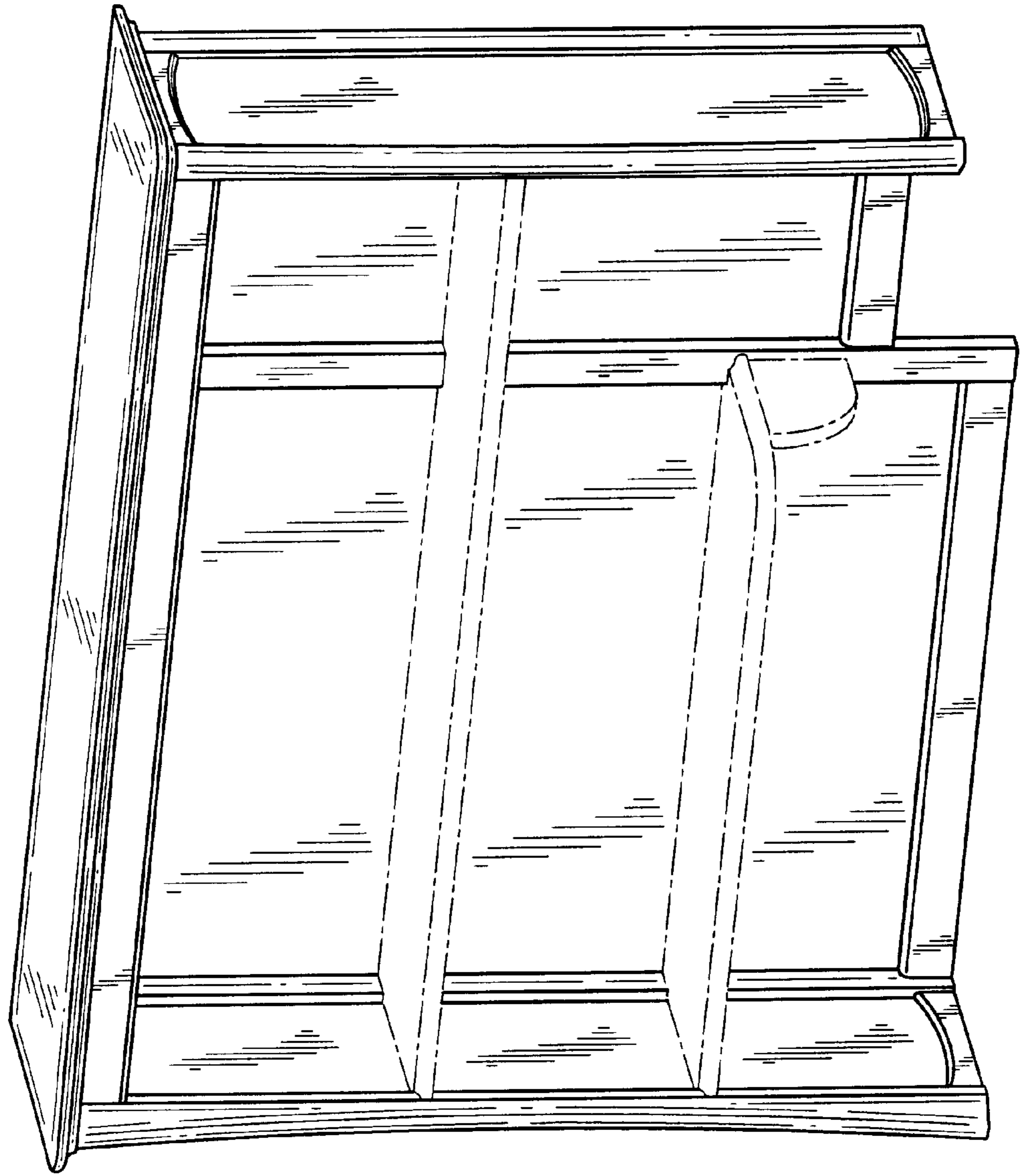
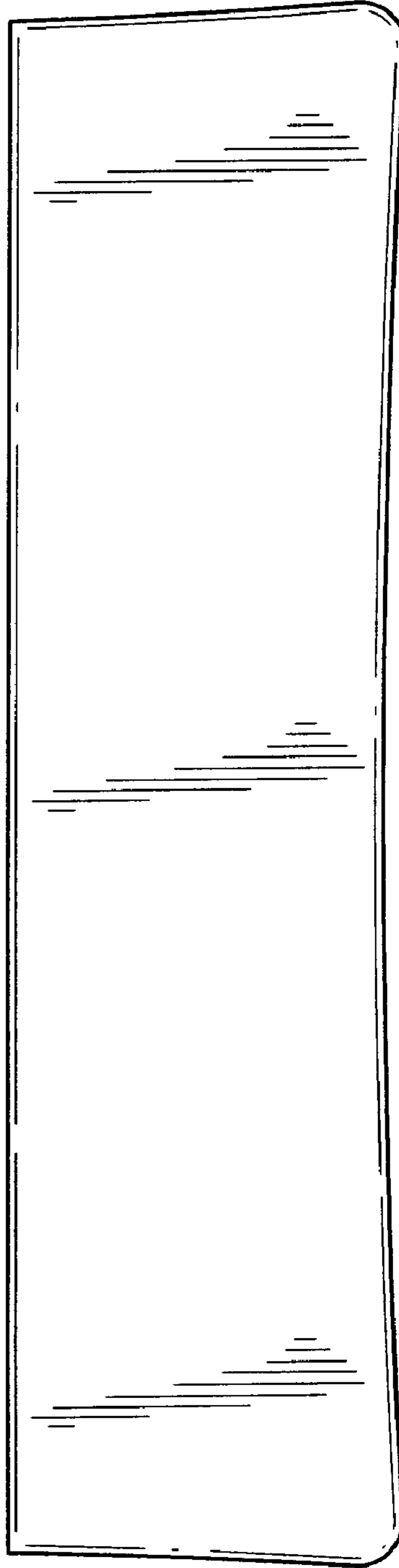

FIG. 1

FIG. 2



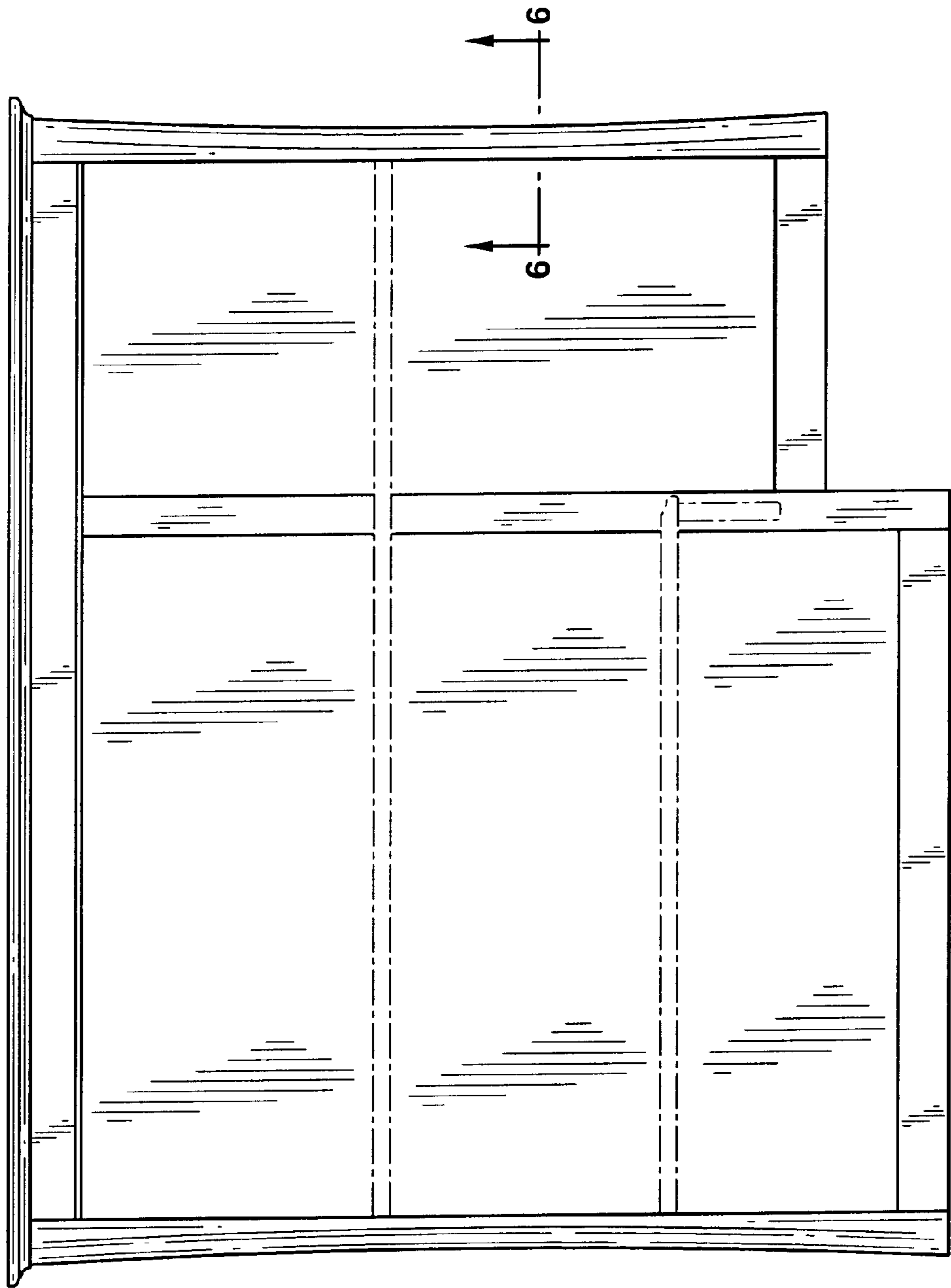

FIG. 3

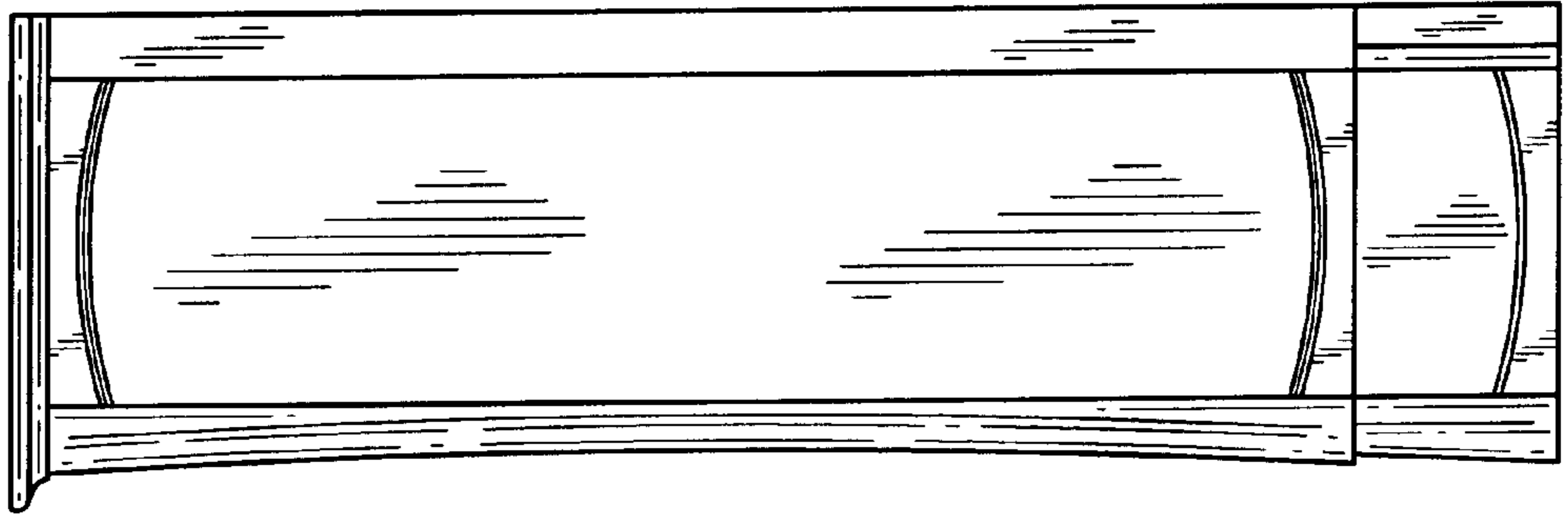

FIG. 4

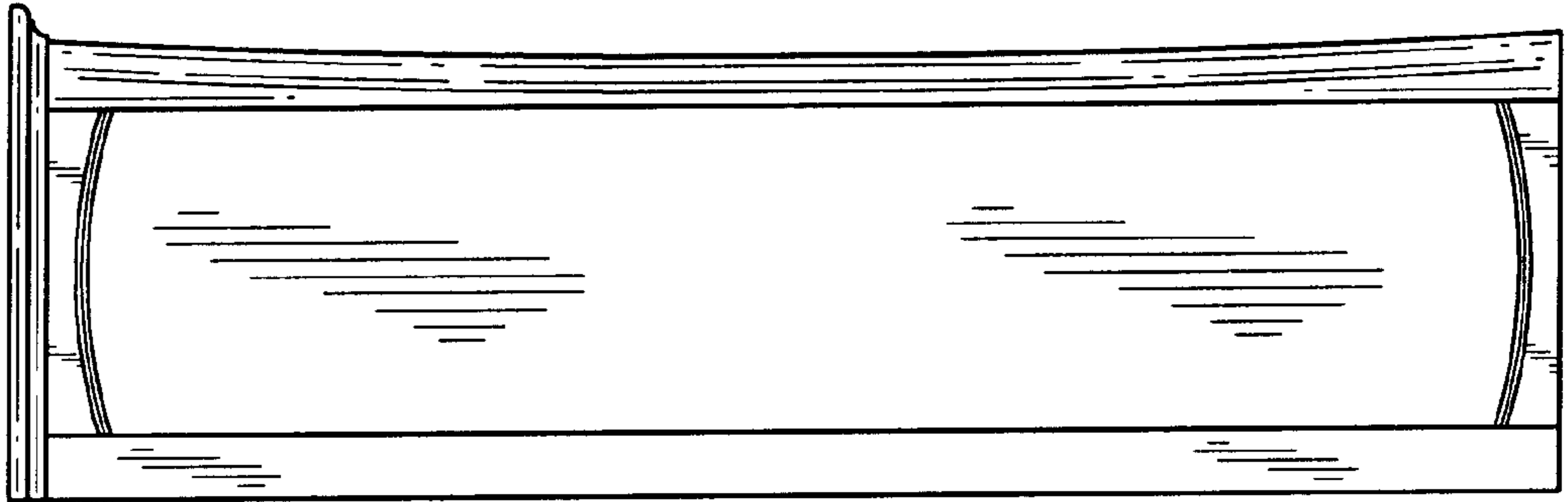

FIG. 5

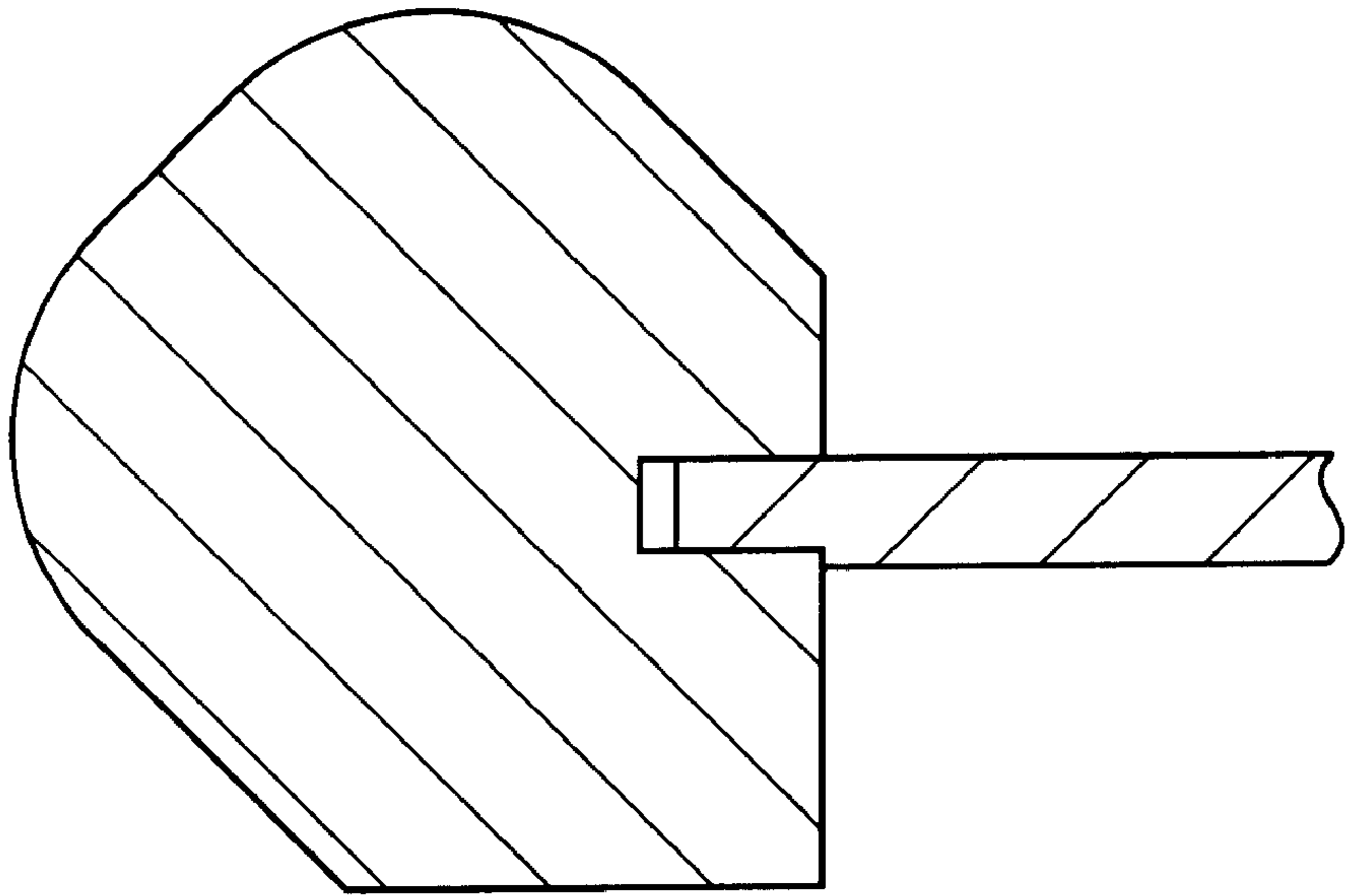

FIG. 6