



US00D435473S

# United States Patent [19]

Eckel et al.

[11] Patent Number: **Des. 435,473**

[45] Date of Patent: **\*\* Dec. 26, 2000**

[54] **COMBINED DIMMER, SWITCH, IR RECEIVER, THERMOSTAT, AMBIENT LIGHT SENSOR AND PASSIVE INFRARED MOTION SENSOR**

D. 398,872	9/1998	Jan	.....	D10/106
D. 413,277	8/1999	Scheibe	.....	D10/106
D. 419,477	1/2000	Wen-Hsiang	.....	D10/106

[75] Inventors: **David P. Eckel**, Eaton's Neck; **Maxim Laurent**, Brooklyn; **James A. Porter**, Farmingdale; **Gaetano Bonasia**, Bronx, all of N.Y.

*Primary Examiner*—Marcus A. Jackson  
*Attorney, Agent, or Firm*—Paul J. Sutton

[73] Assignee: **Leviton Manufacturing Co., Inc.**, Little Neck, N.Y.

[57] **CLAIM**

[\*\*] Term: **14 Years**

The ornamental design for a combined dimmer, switch, IR receiver, thermostat, ambient light sensor, and passive infrared motion sensor, as shown and described.

[21] Appl. No.: **29/116,305**

**DESCRIPTION**

[22] Filed: **Dec. 29, 1999**

FIG. 1 is a front and upper right perspective view combined dimmer, switch, IR receiver, thermostat, ambient light sensor and passive infrared motion sensor showing our new design;

[51] **LOC (7) Cl.** ..... **10-05**

FIG. 2 is a top view thereof;

[52] **U.S. Cl.** ..... **D10/106**

FIG. 3 is a front elevational view thereof;

[58] **Field of Search** ..... D10/104, 106, D10/116, 121; 340/541, 542, 543, 544, 545, 551, 571, 572, 573, 689

FIG. 4 is a left side elevational view thereof;

FIG. 5 is a right side elevational view thereof;

FIG. 6 is a rear elevational view thereof; and,

FIG. 7 is a bottom plan view thereof.

[56] **References Cited**

**U.S. PATENT DOCUMENTS**

D. 381,283 7/1997 Soreo ..... D10/106

**1 Claim, 4 Drawing Sheets**

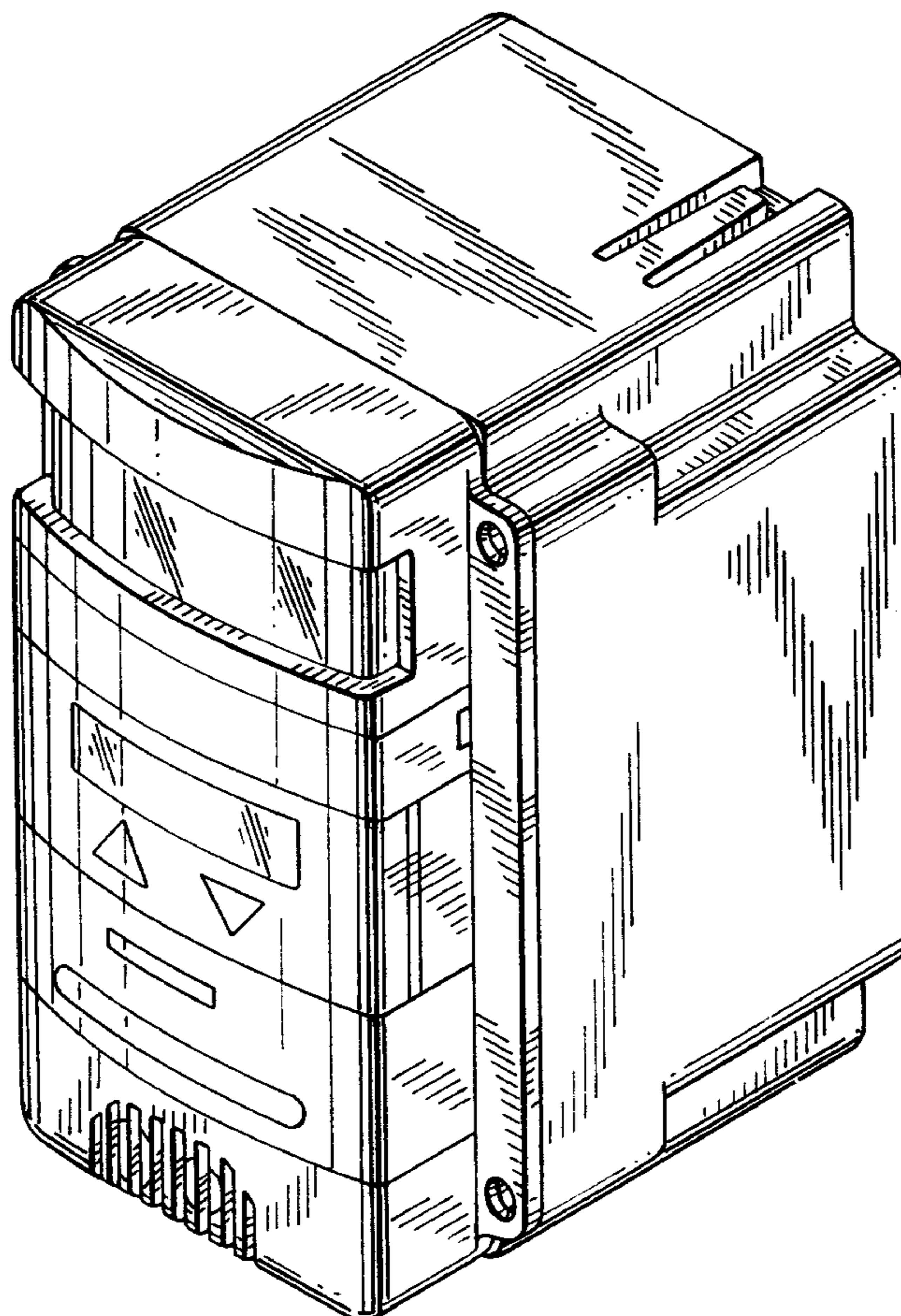

*FIG. 1*

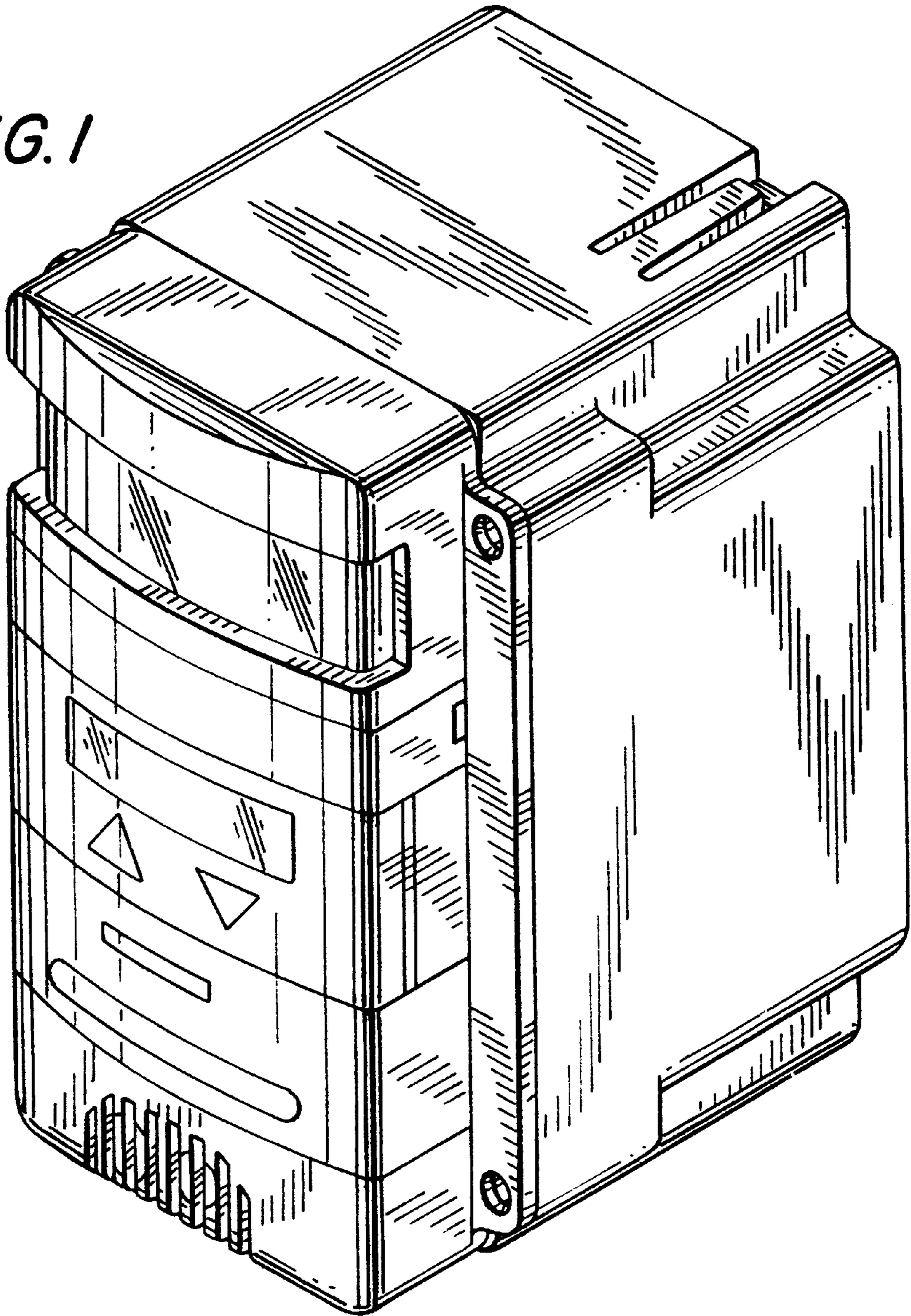

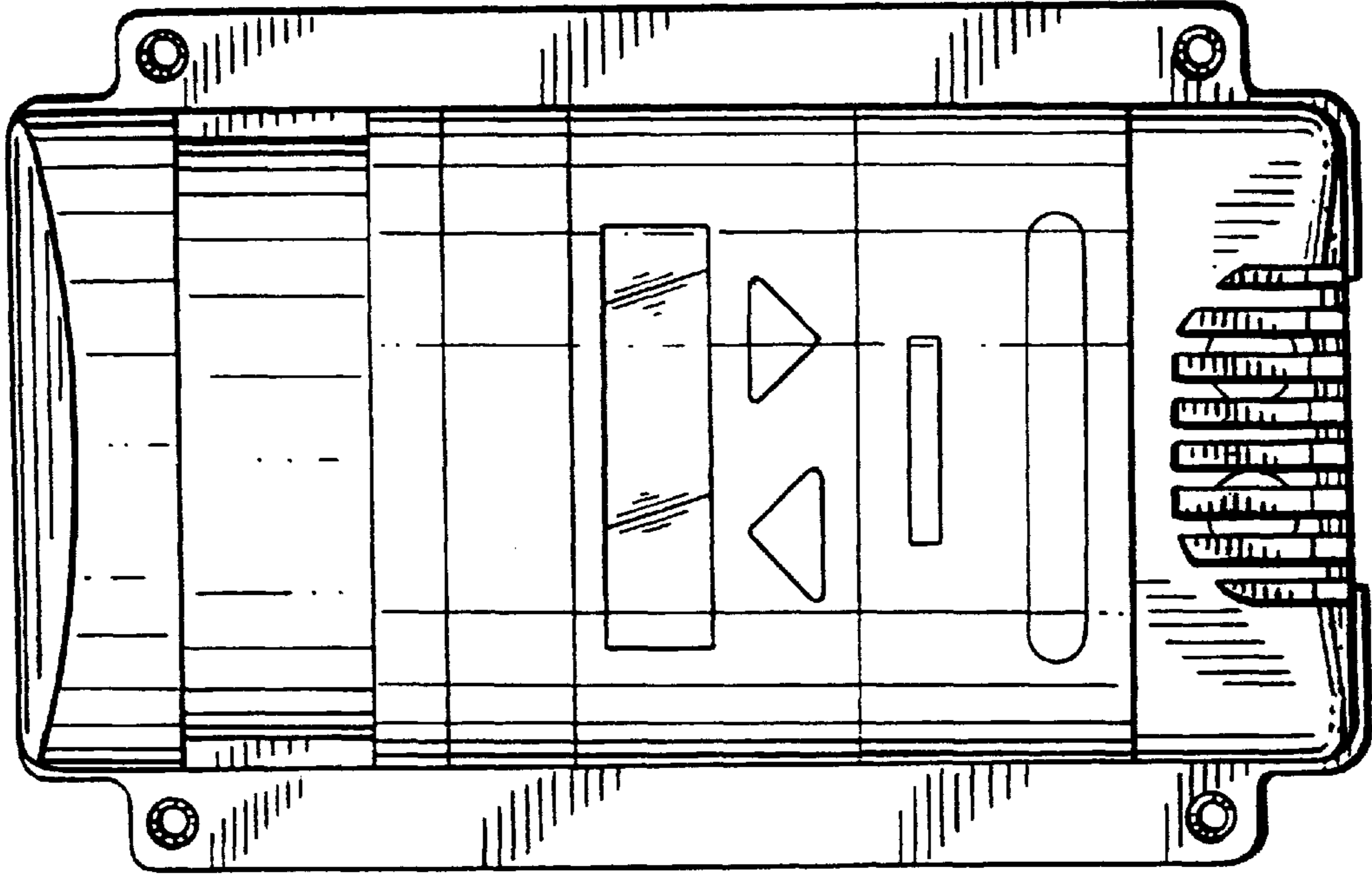

FIG. 3

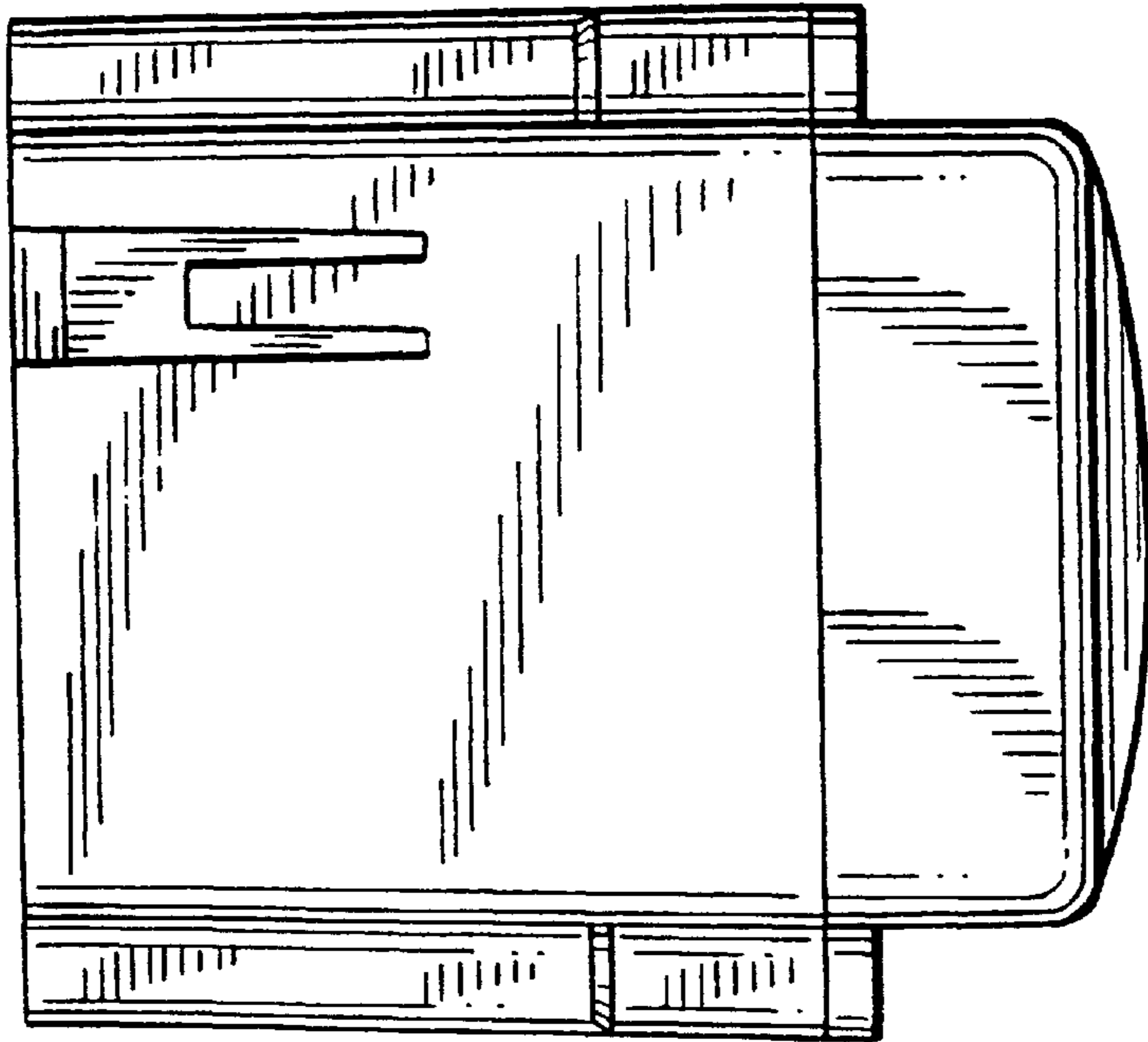

FIG. 2

FIG. 5

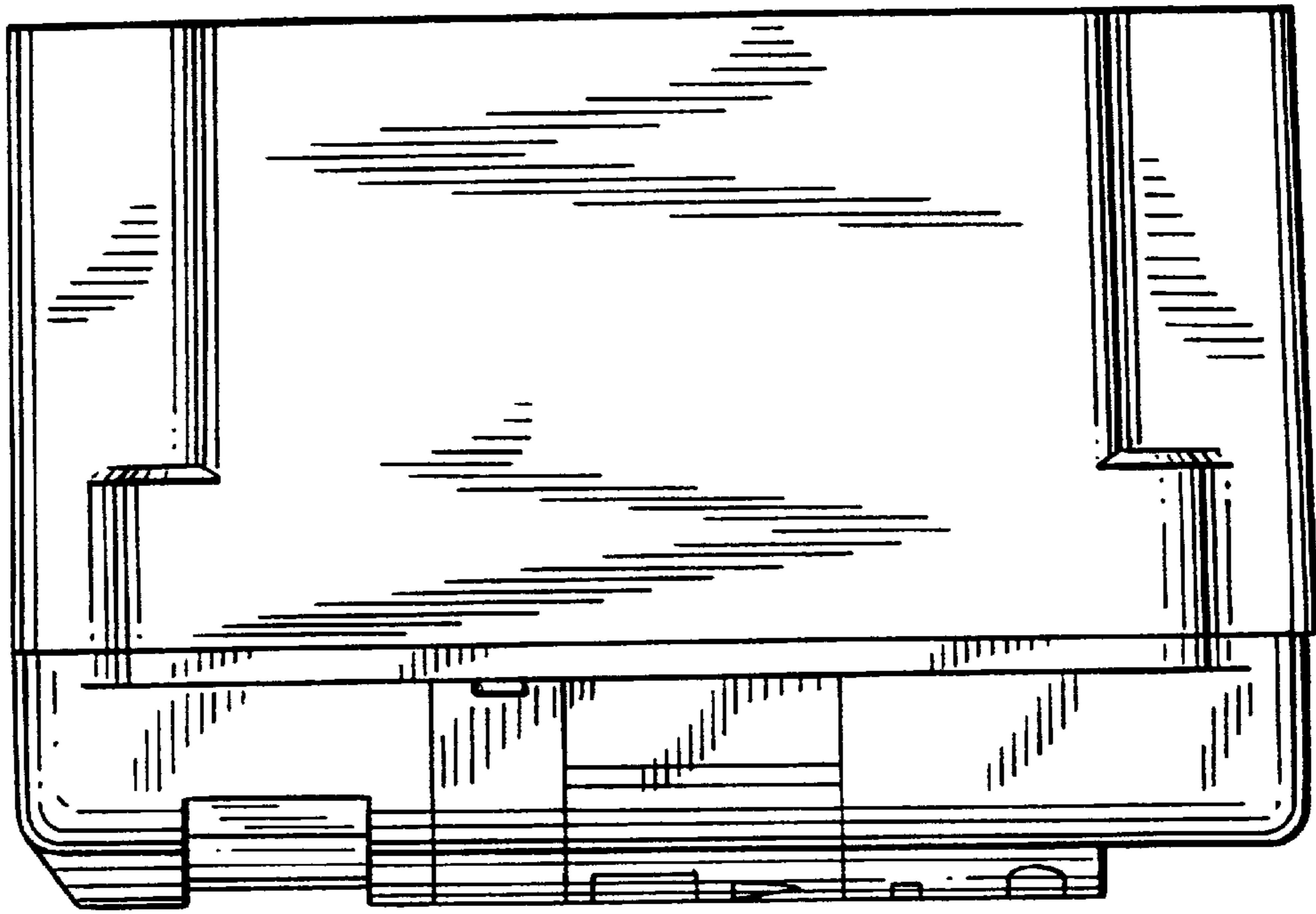

FIG. 4

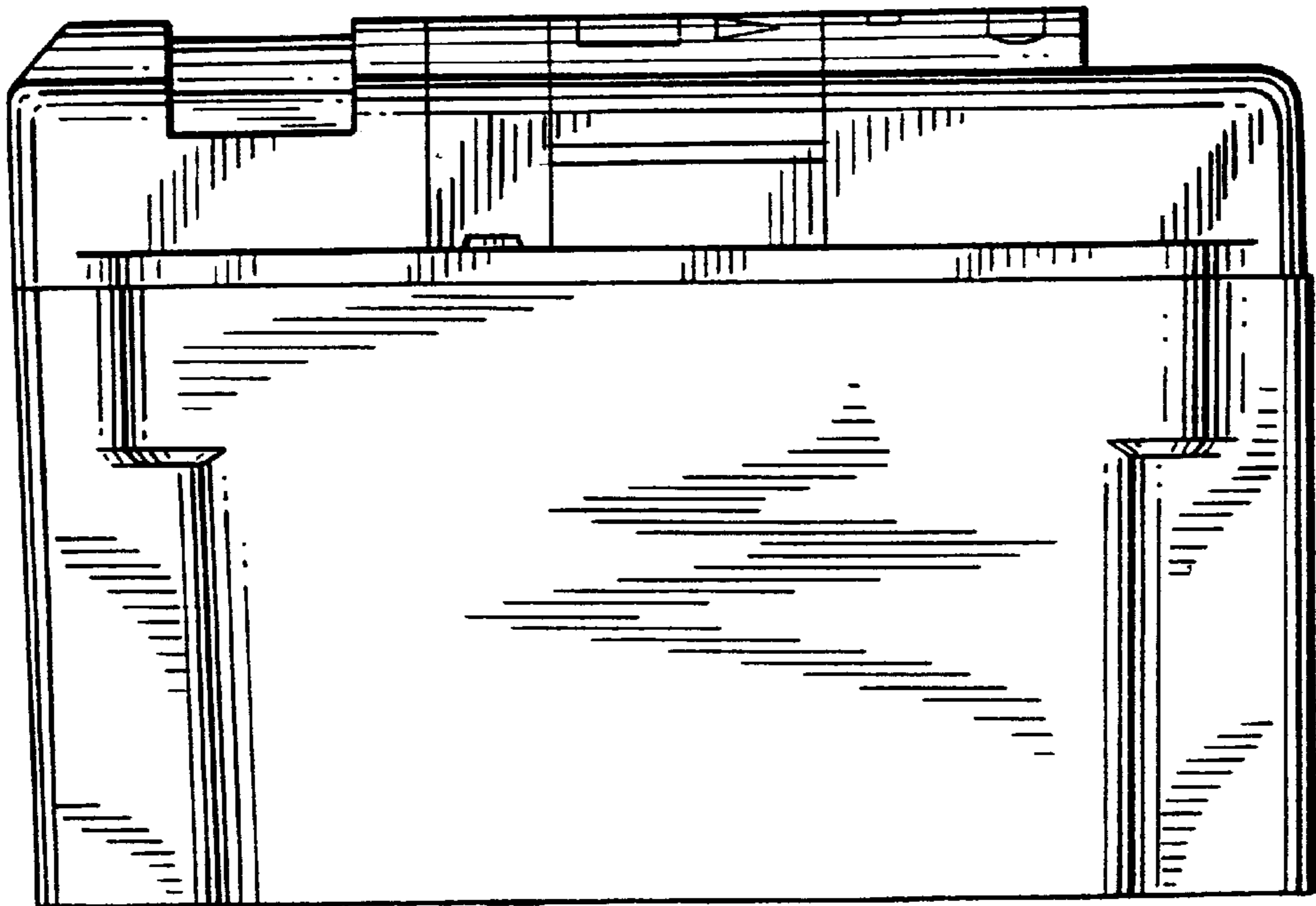

FIG. 7

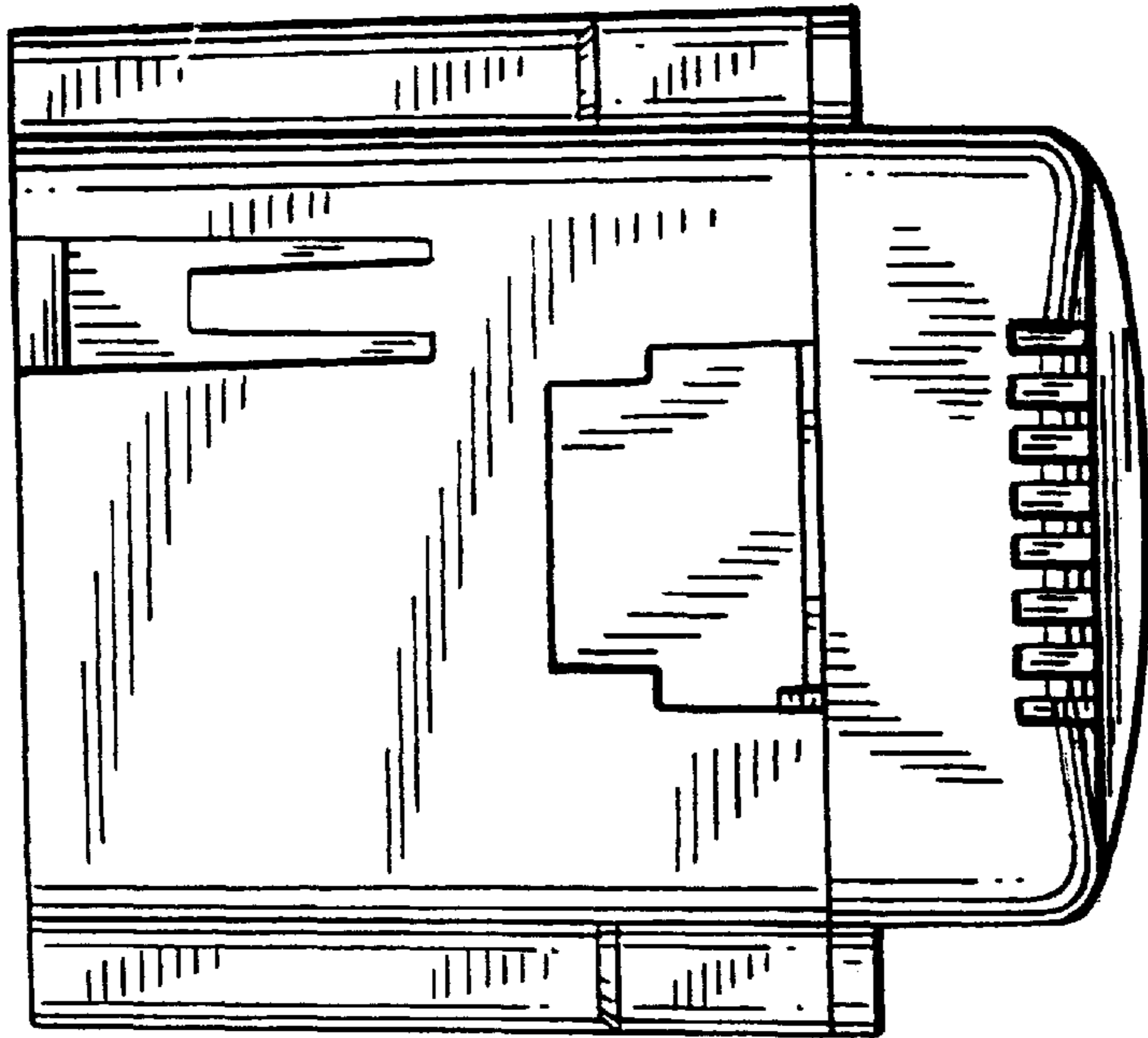

FIG. 6

