



US00D435464S

United States Patent [19]
Bland et al.

[11] **Patent Number: Des. 435,464**
[45] **Date of Patent: ** Dec. 26, 2000**

[54] **WATCH**

[75] Inventors: **Diarmuid John St. Colum Bland;**
Carla Louise Carr, both of Garland;
Jeffrey Keith Bruneau, Dallas;
William Warren Morgan, III, The
Colony, all of Tex.

[73] Assignee: **Fossil, Inc.**, Richardson, Tex.

[**] Term: **14 Years**

[21] Appl. No.: **29/112,438**

[22] Filed: **Oct. 15, 1999**

[51] **LOC (7) Cl.** **10-02**

[52] **U.S. Cl.** **D10/39; D10/30**

[58] **Field of Search** D10/1-40, 122-132;
368/280-282, 276-277, 28-30, 285, 239-242,
243-249, 82-84, 41-44, 223, 232

[56] **References Cited**

U.S. PATENT DOCUMENTS

D. 240,605	7/1976	Sticker .	
D. 242,694	12/1976	Thompson et al.	D10/126
D. 247,083	1/1978	Gruber	D6/494
D. 257,963	1/1981	Sticker	D10/126
D. 299,316	1/1989	Vickery	D10/15
D. 364,820	12/1995	Sakai et al.	D10/39
D. 387,677	12/1997	Hanagata	D10/30
D. 390,799	2/1998	Uptegraph	D10/126
D. 416,499	11/1999	Bland et al.	D10/39
D. 417,400	12/1999	Yamamoto	D10/30
D. 427,080	6/2000	Hanagata	D10/30
4,095,405	6/1978	Tanaka	368/34
4,198,810	4/1980	Fahrenschon	368/239
4,355,380	10/1982	Huguenin et al.	368/71
4,400,092	8/1983	Piquet et al.	368/82
4,413,915	11/1983	Besson	368/71
4,742,501	5/1988	Coster	368/82
5,748,568	5/1998	Harrison	368/82

Primary Examiner—Nelson C. Holtje
Attorney, Agent, or Firm—Strasburger & Price, LLP

[57] **CLAIM**

I claim the ornamental design for the watch, as shown and described.

DESCRIPTION

FIG. 1 is a front elevational view of a watch showing my new design.

FIG. 2 is a front elevational view of the dial face only showing the DATE indicator;

FIG. 3 is a front elevational view of the dial face only showing a typical date indication;

FIG. 4 is a front elevational view of the dial face only showing the TIME indicator.

FIG. 5 is a front elevational view of the dial face only showing a typical time indication;

FIG. 6 is a front elevational view of the dial face only showing the ALARM indicator;

FIG. 7 is a front elevational view of the dial face only showing a typical alarm indication;

FIG. 8 is a front elevational view of the dial face only showing the CHRONOGRAPH indicator;

FIG. 9 is a front elevational view of the face only showing a typical indication;

FIG. 10 is a front elevational view of the face only showing the TIMER indicator;

FIG. 11 is a front elevational view of the face only showing a typical timer indication;

FIG. 12 is a front elevational view of all possible “second” indication of the inner dial face, 0-59;

FIG. 13 is a left side elevational view of the watch;

FIG. 14 is a an inverted top plan view of the watch;

FIG. 15 is a right side elevational view of the watch;

FIG. 16 is a bottom plan view of the watch; and,

FIG. 17 is a left-front and bottom perspective view of the watch.

The broken line showings of a band in FIGS. 13-17 are environmental only and form no part of the claimed design; and in FIGS. 2-12, the watchcase, bezel, and hands have been omitted for ease of illustration.

The back view of the claimed invention is unornamented.

1 Claim, 5 Drawing Sheets

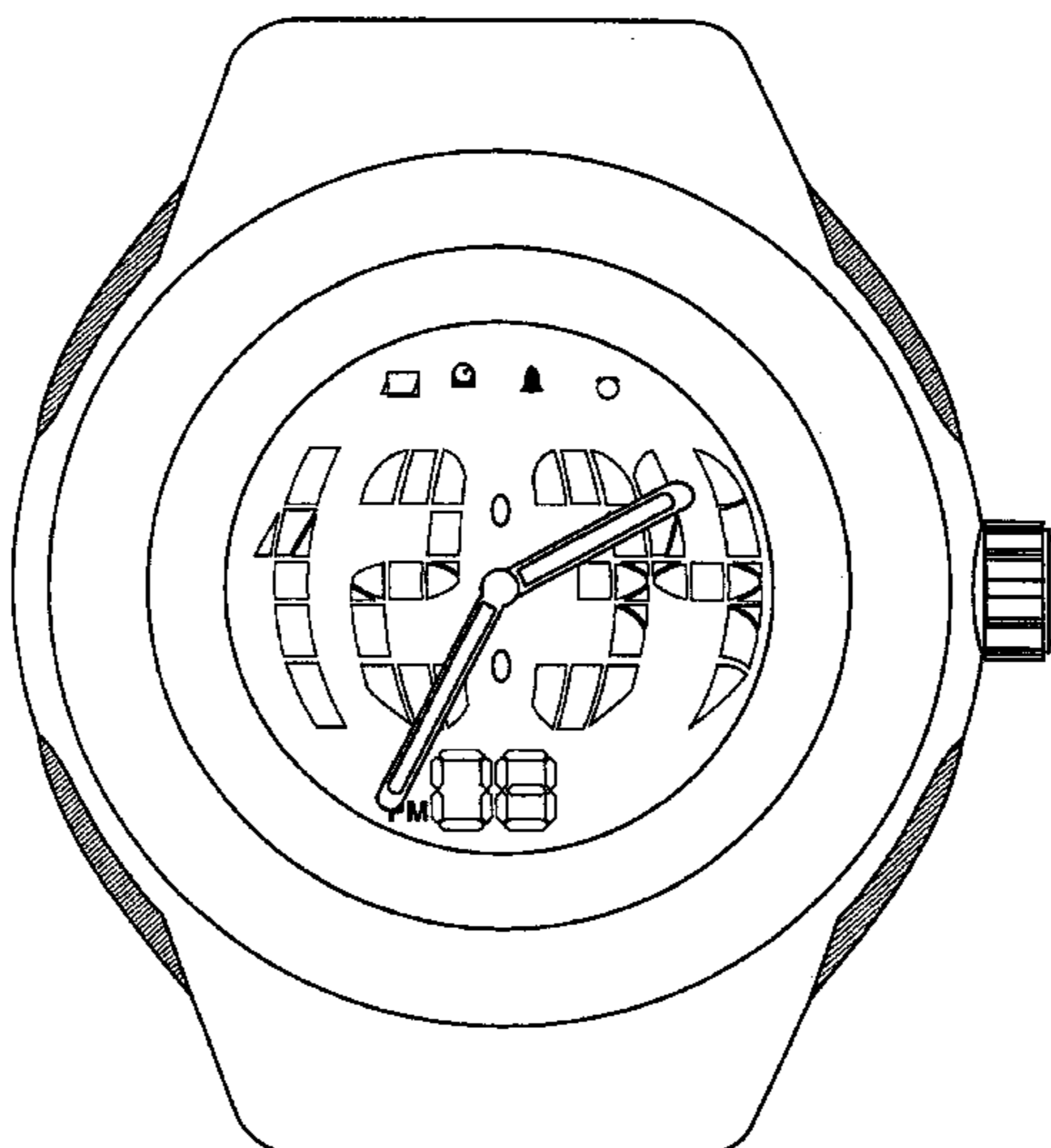

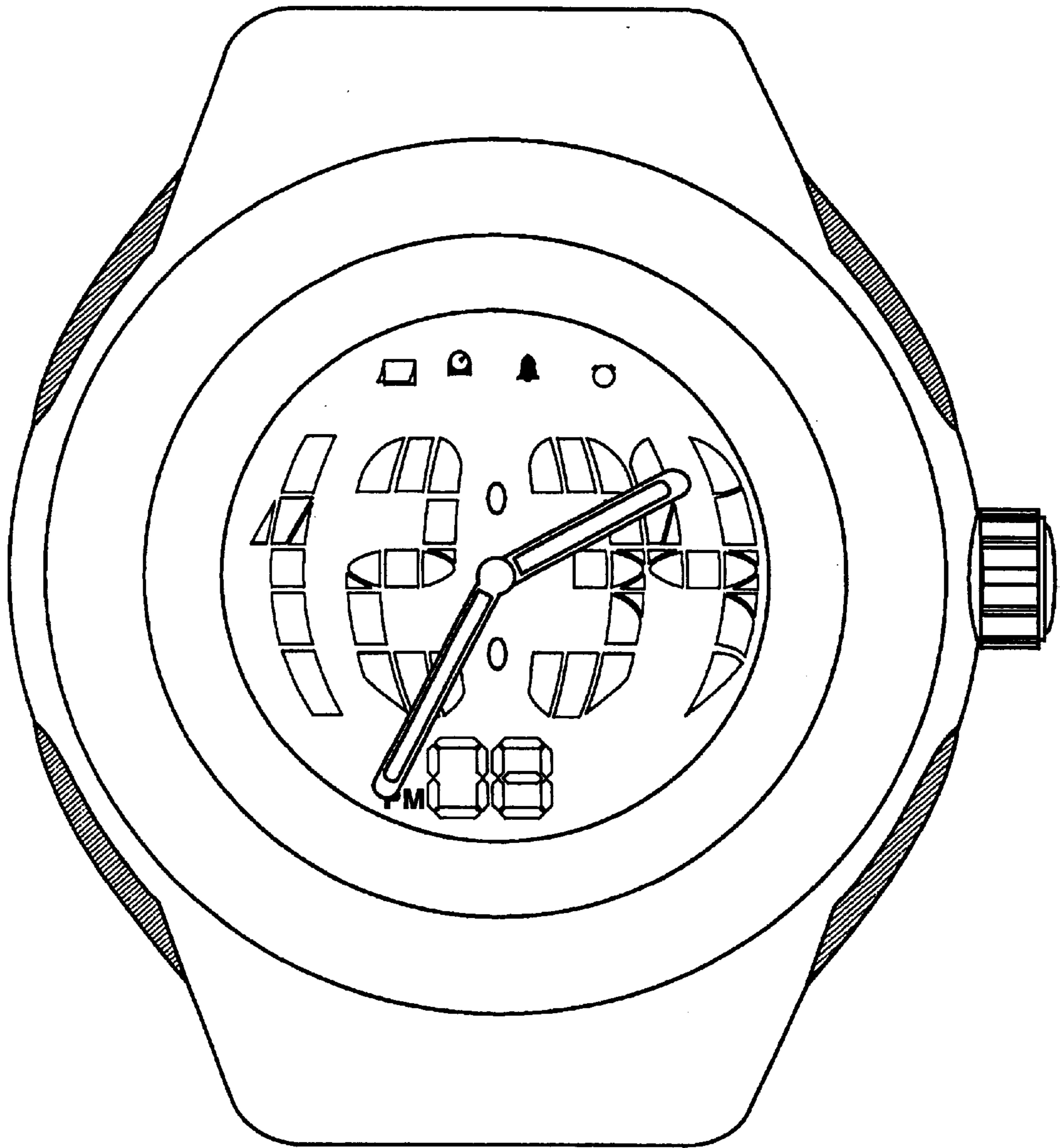

FIG. 1

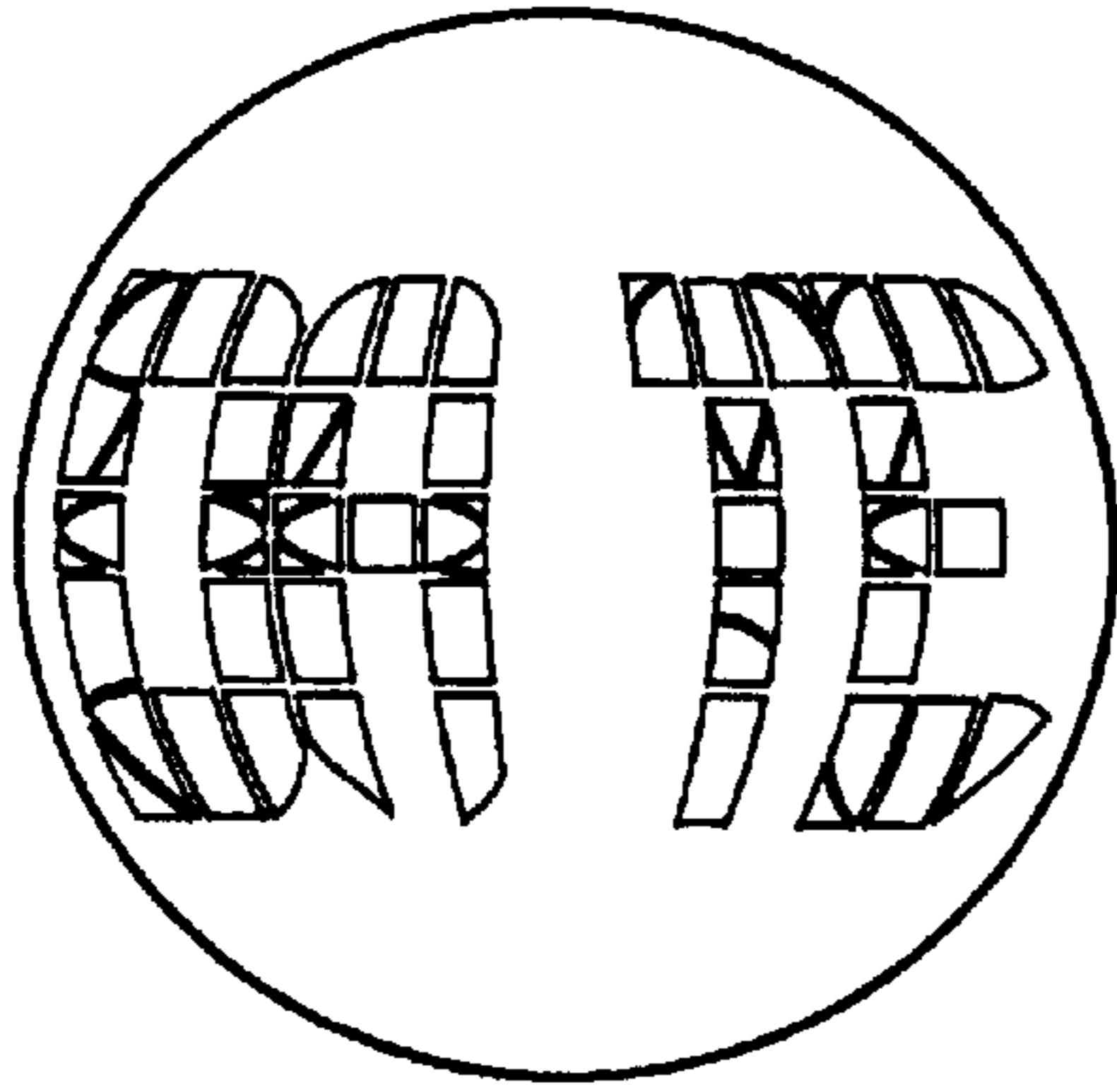

FIG. 2

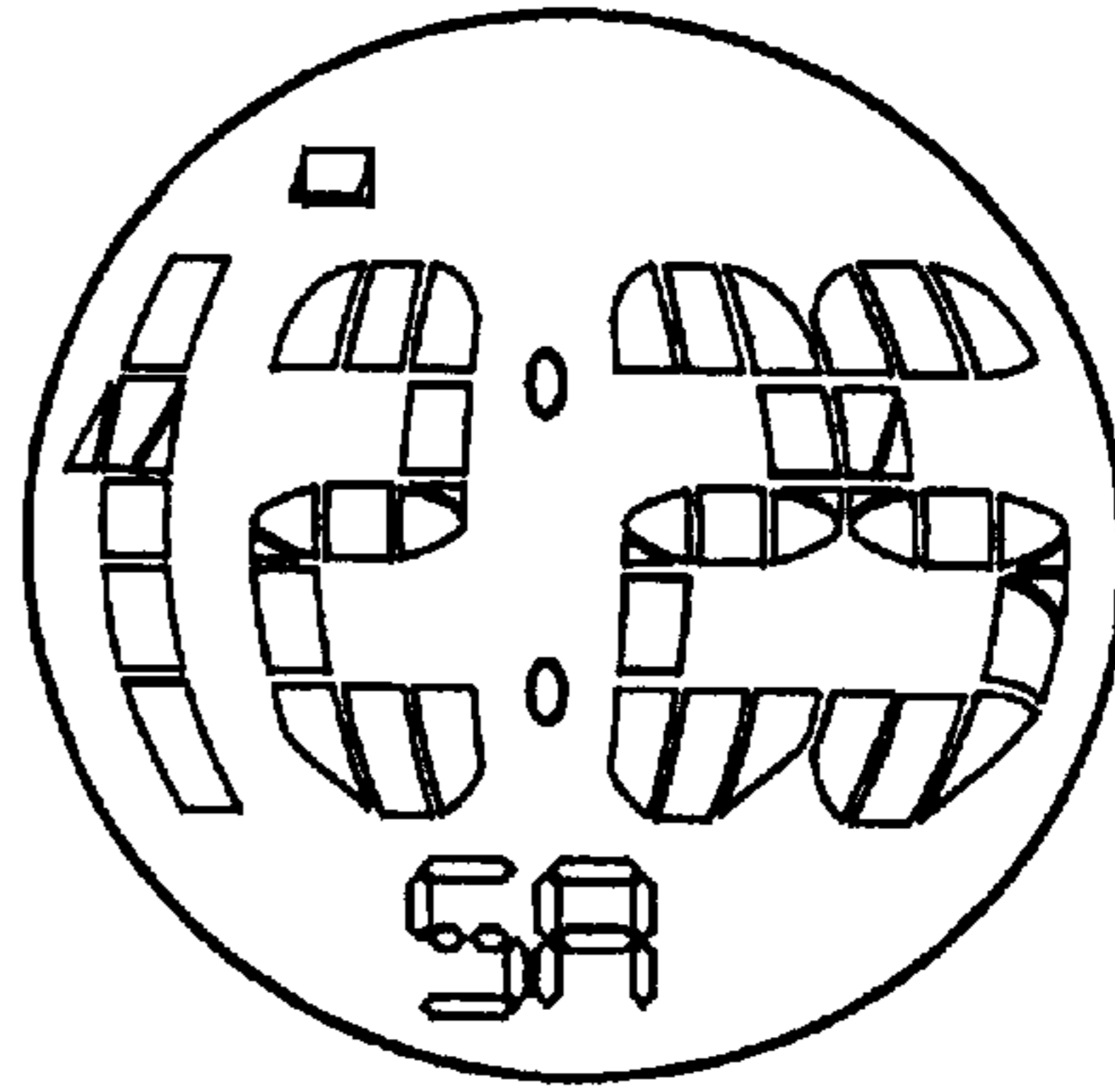

FIG. 3

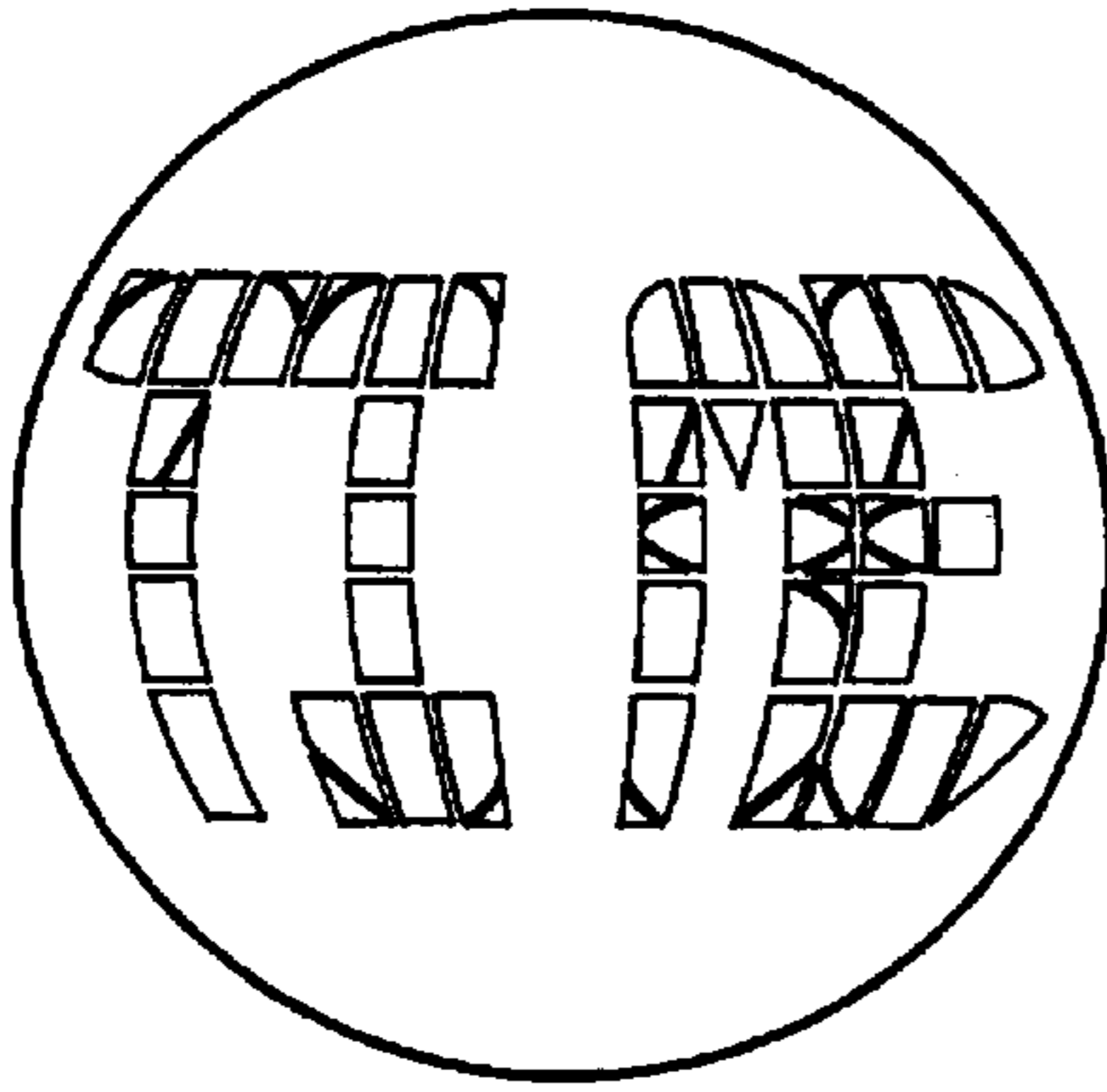

FIG. 4

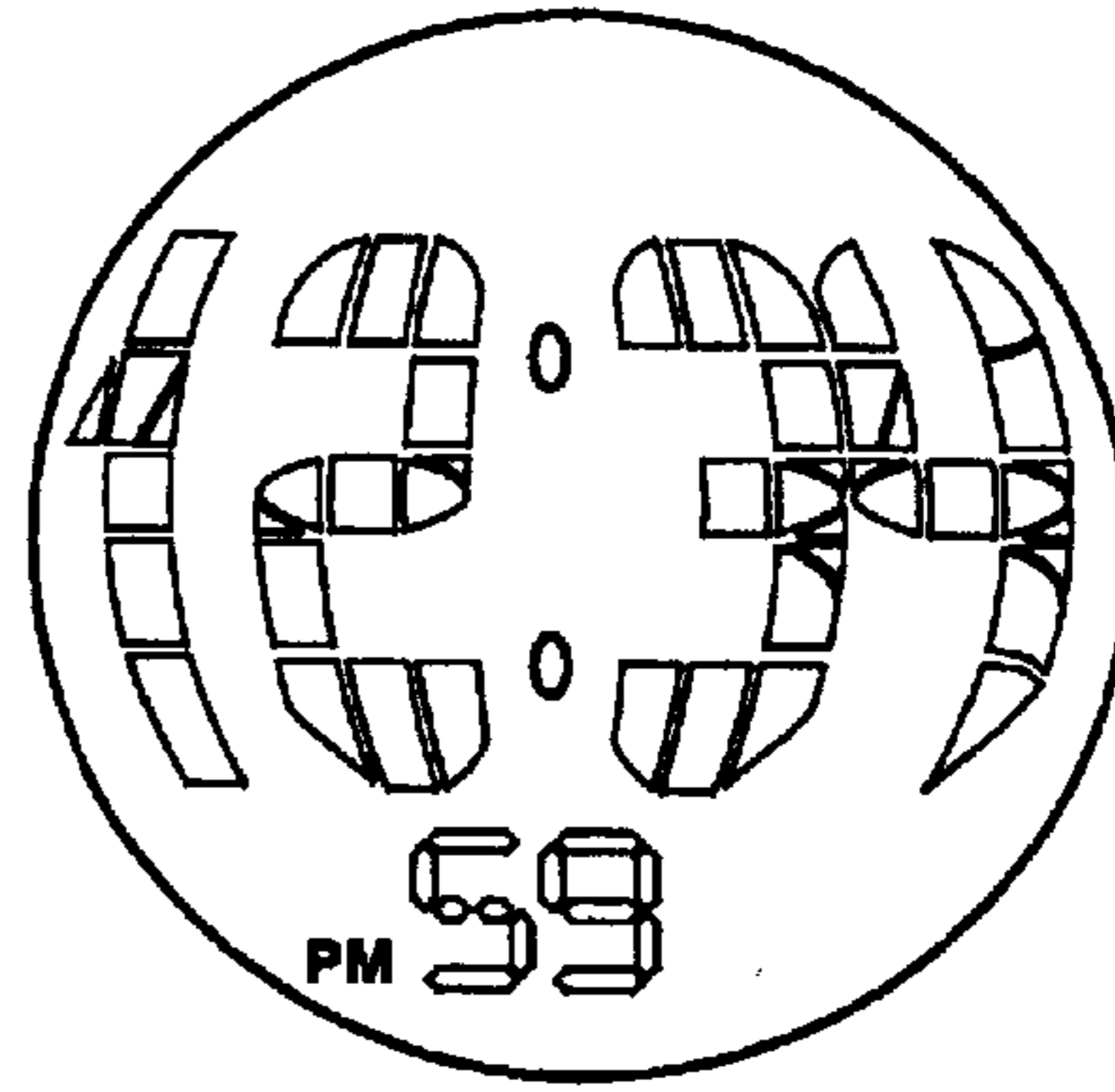

FIG. 5

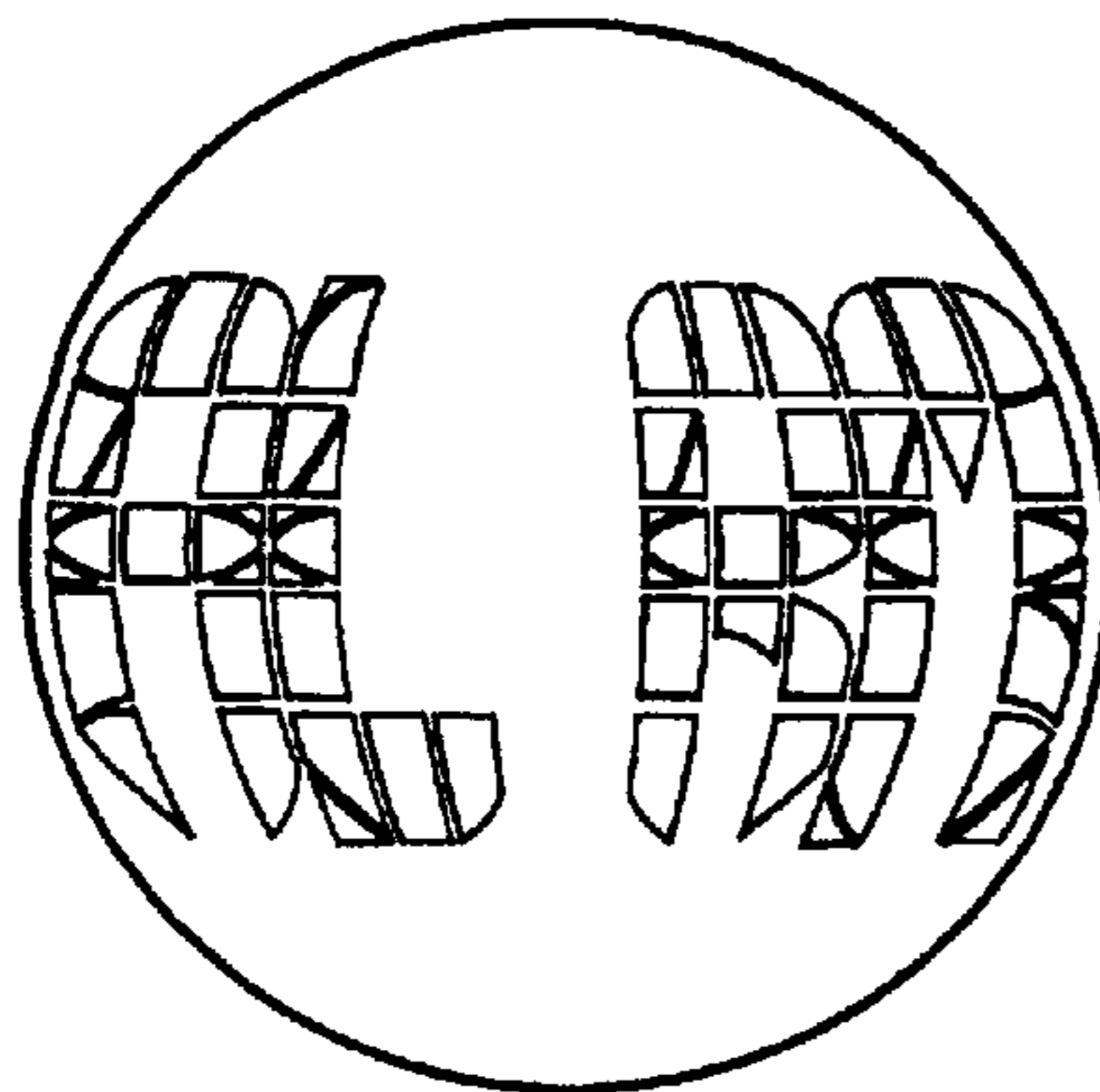

FIG. 6

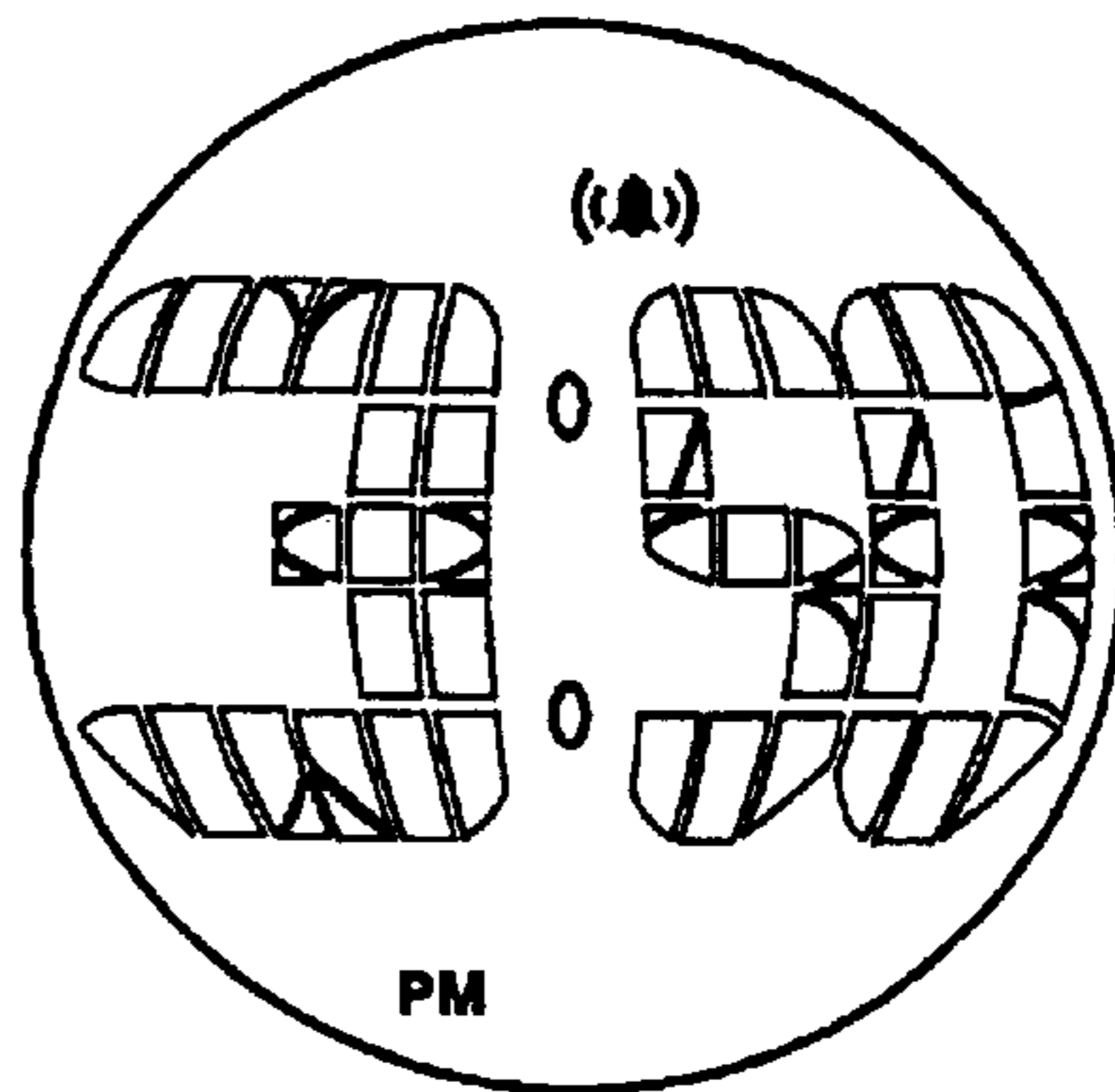

FIG. 7

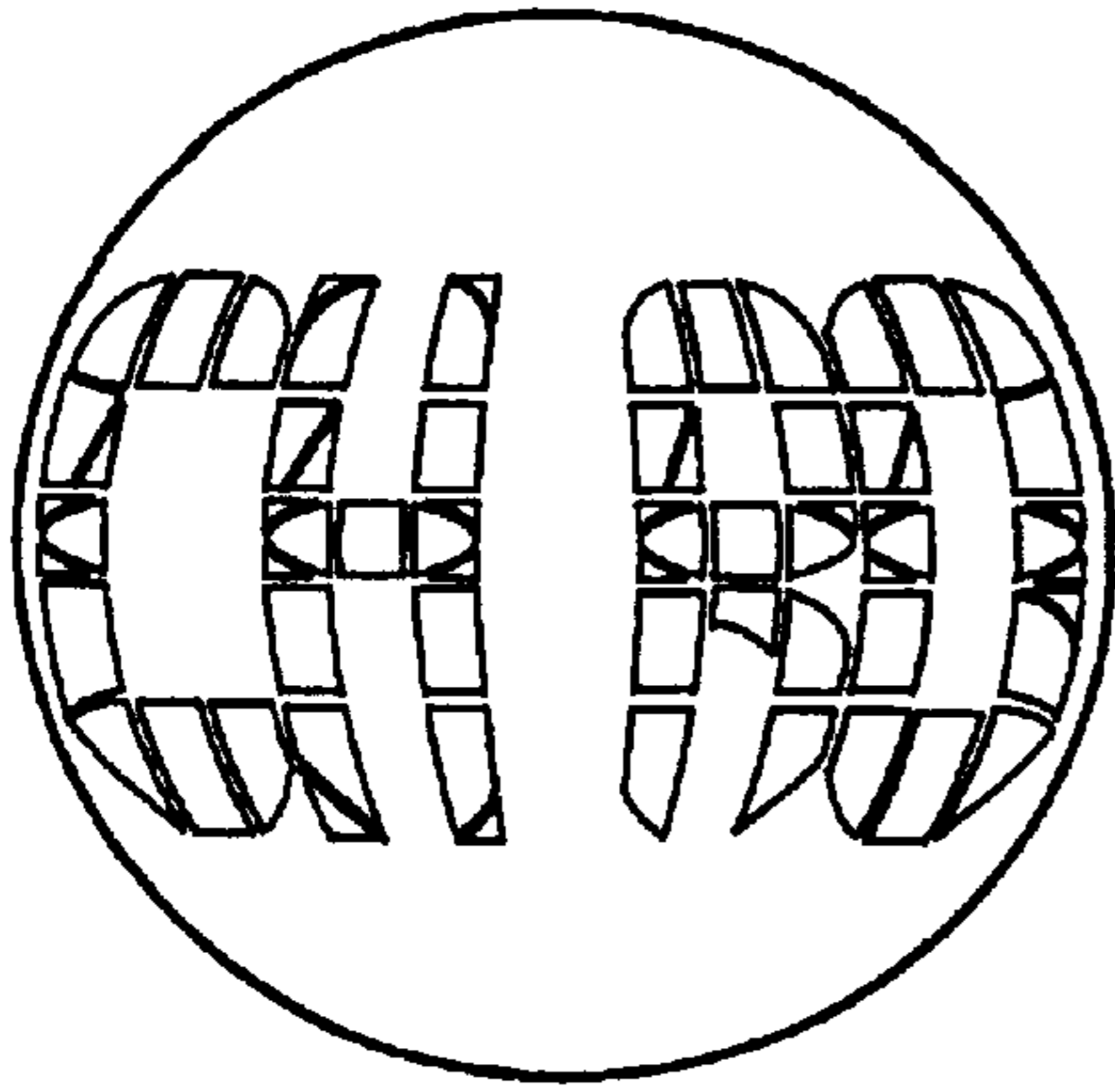

FIG. 8

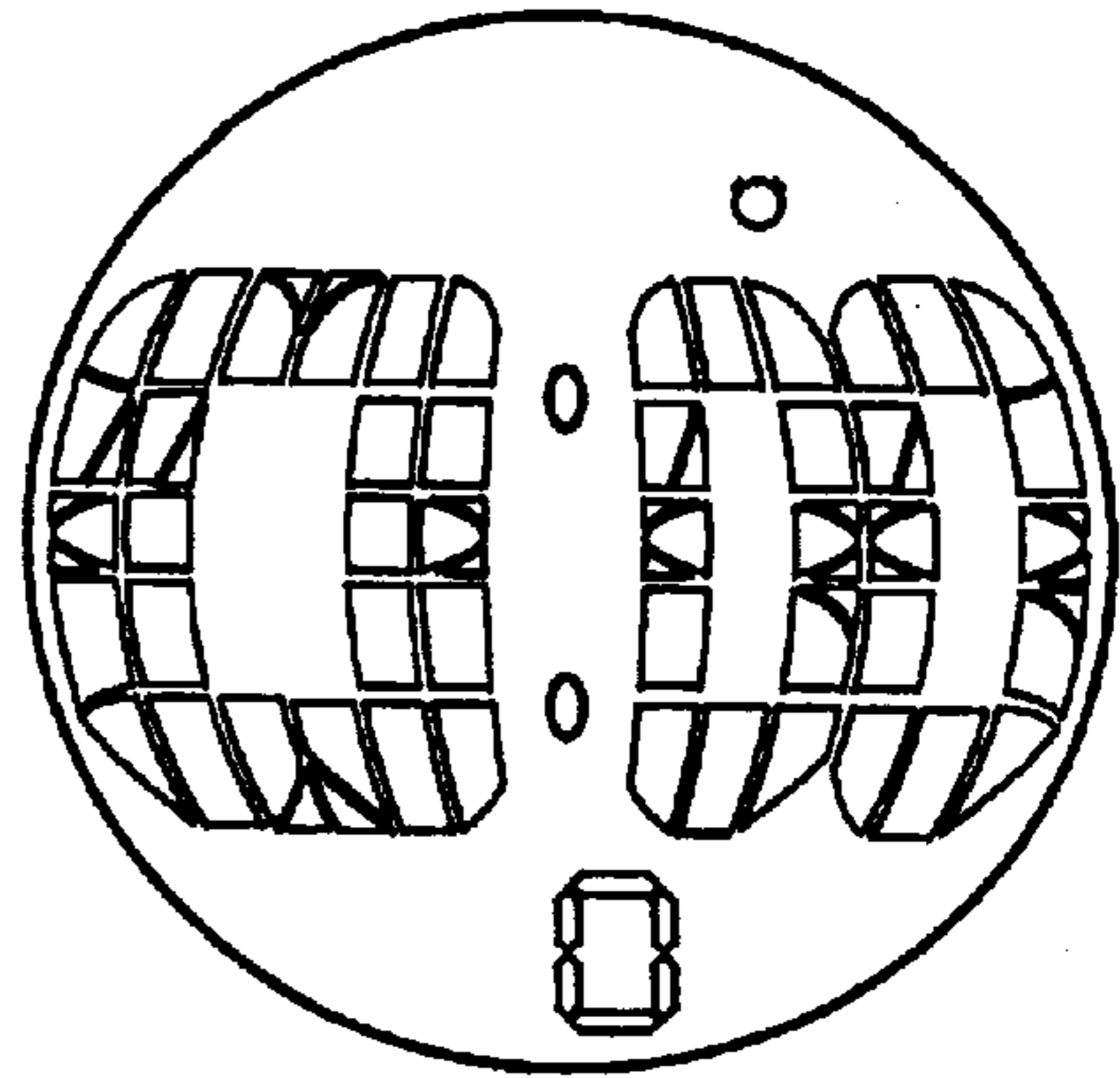

FIG. 9

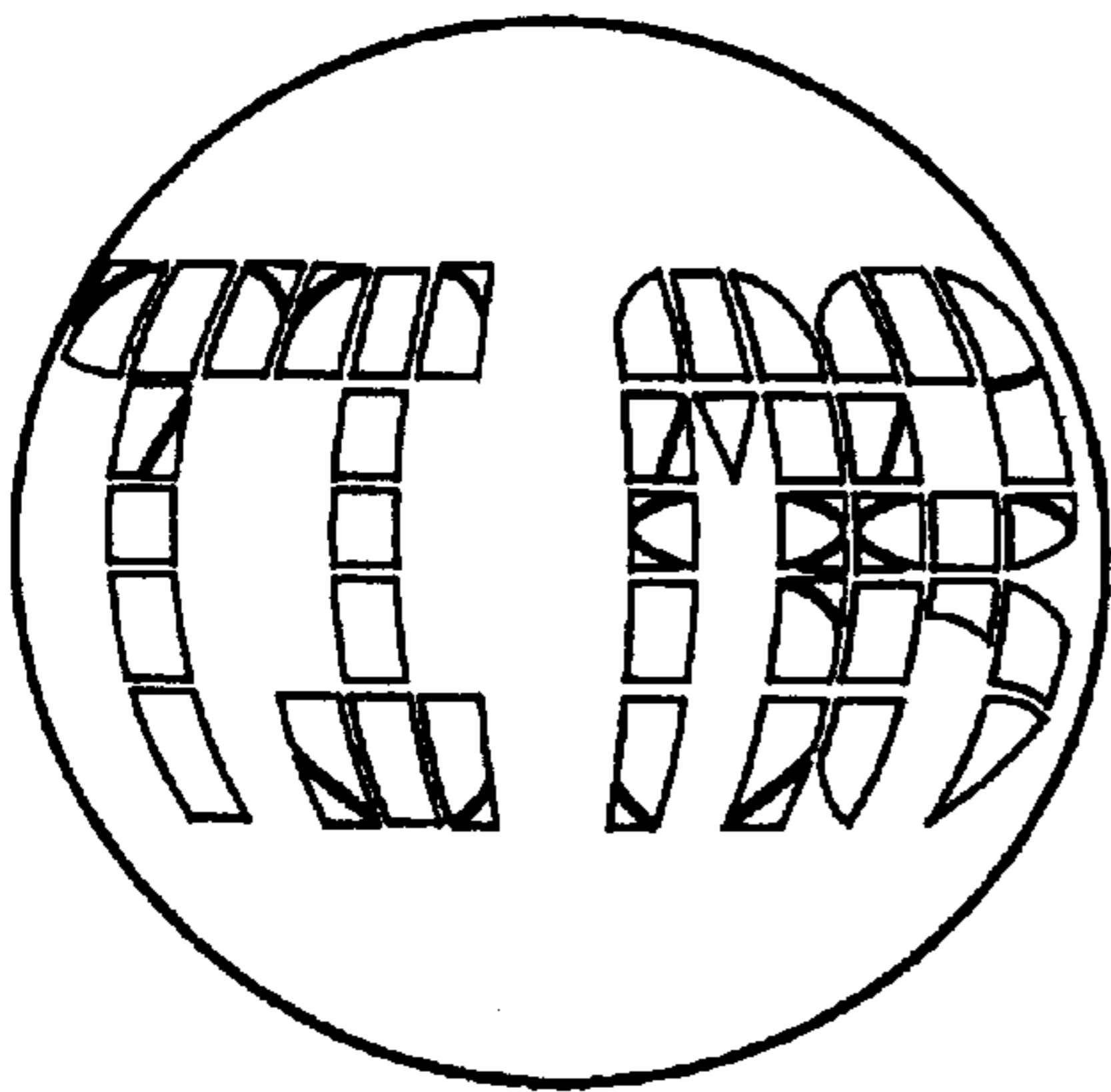

FIG. 10

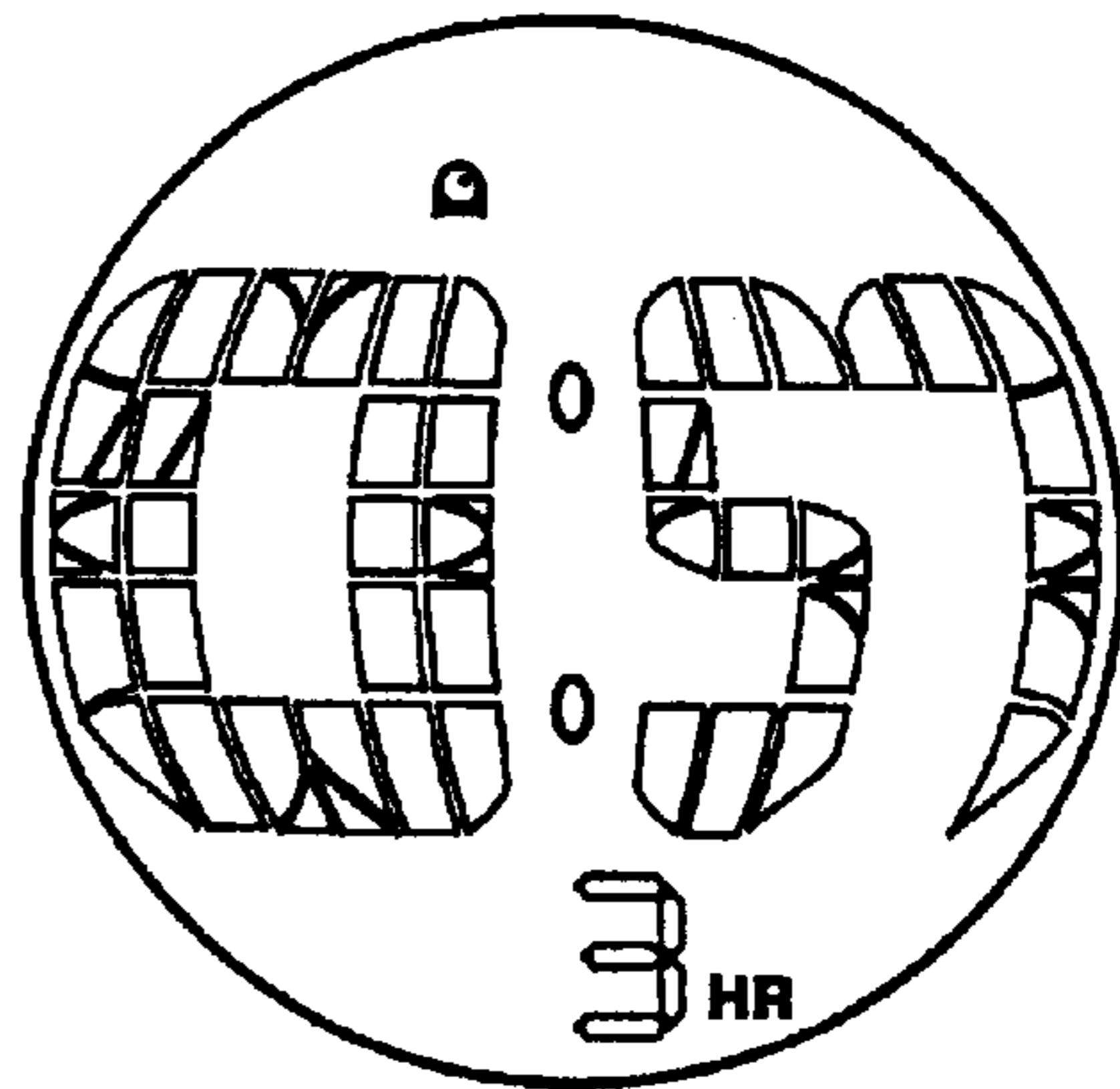

FIG. 11

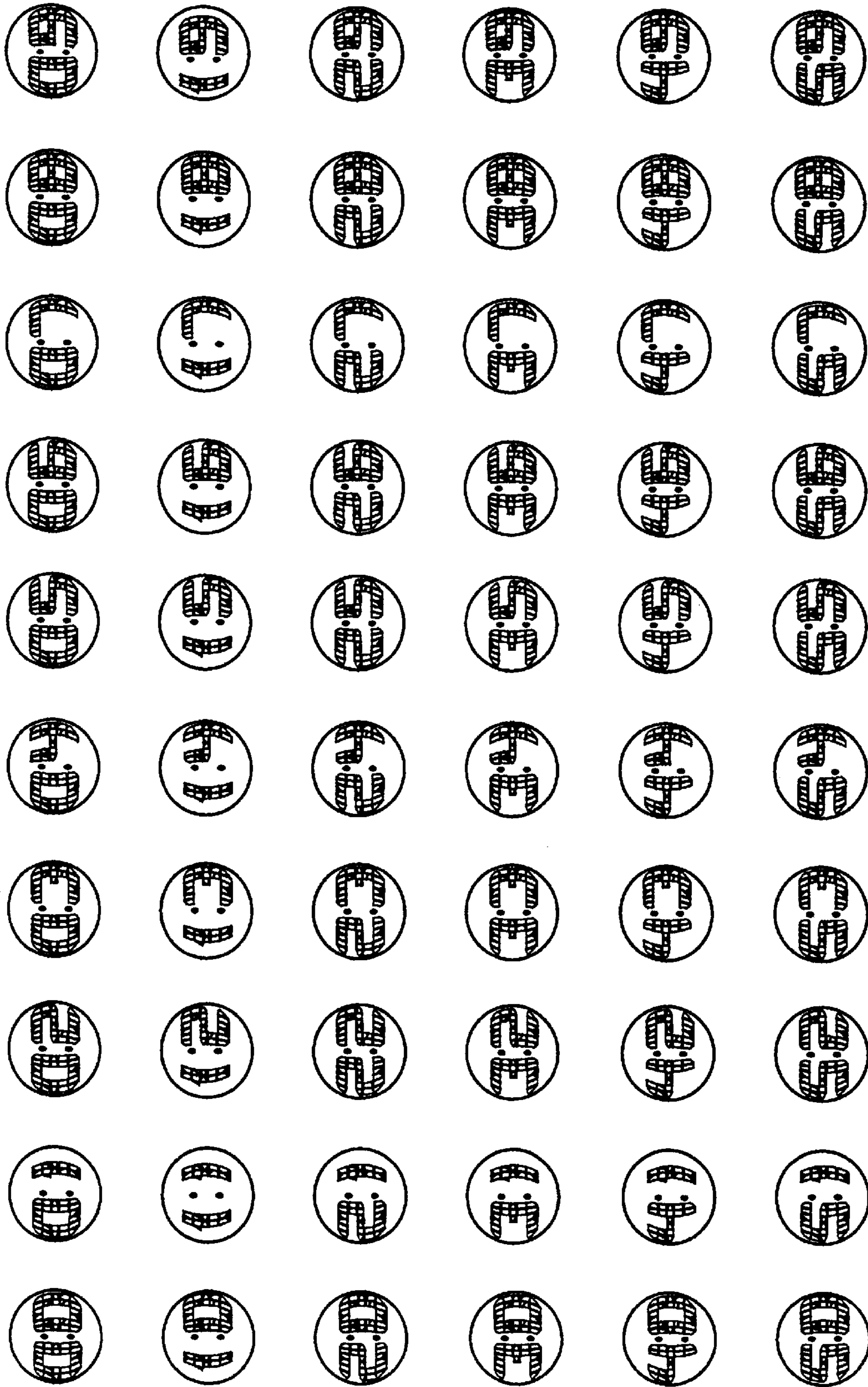

FIG. 12

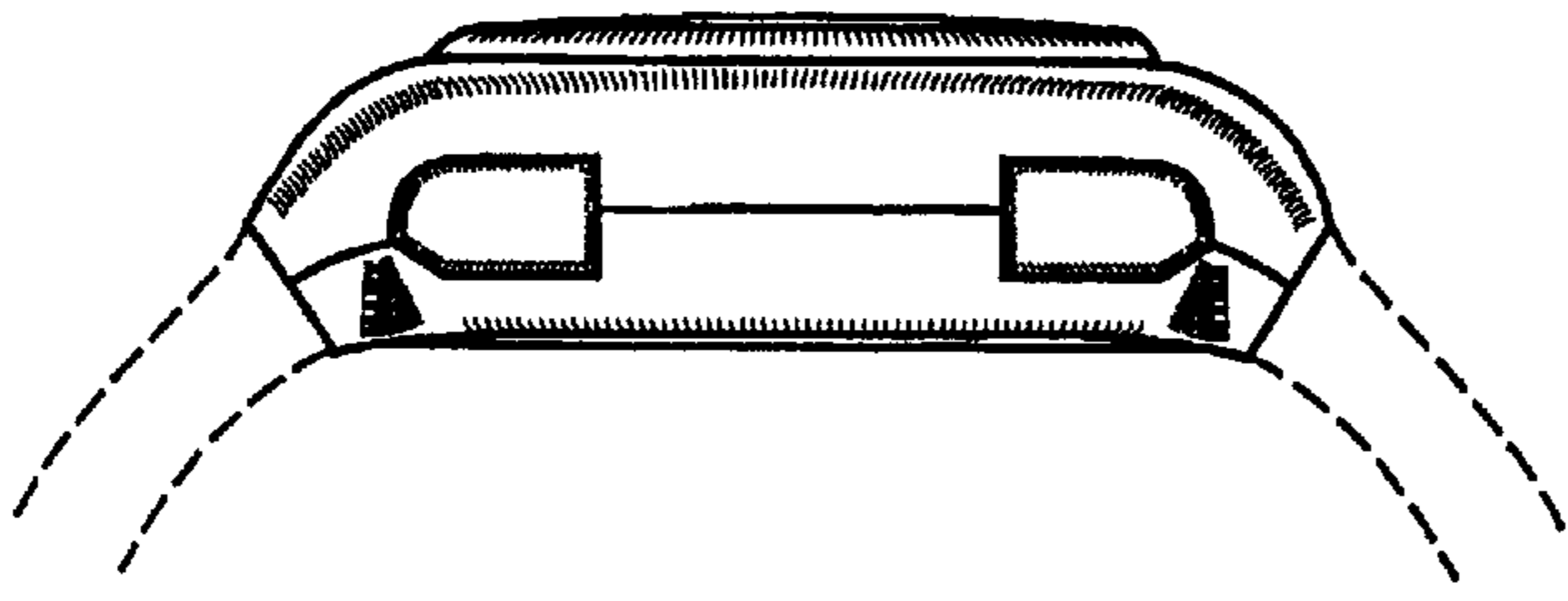

FIG. 13

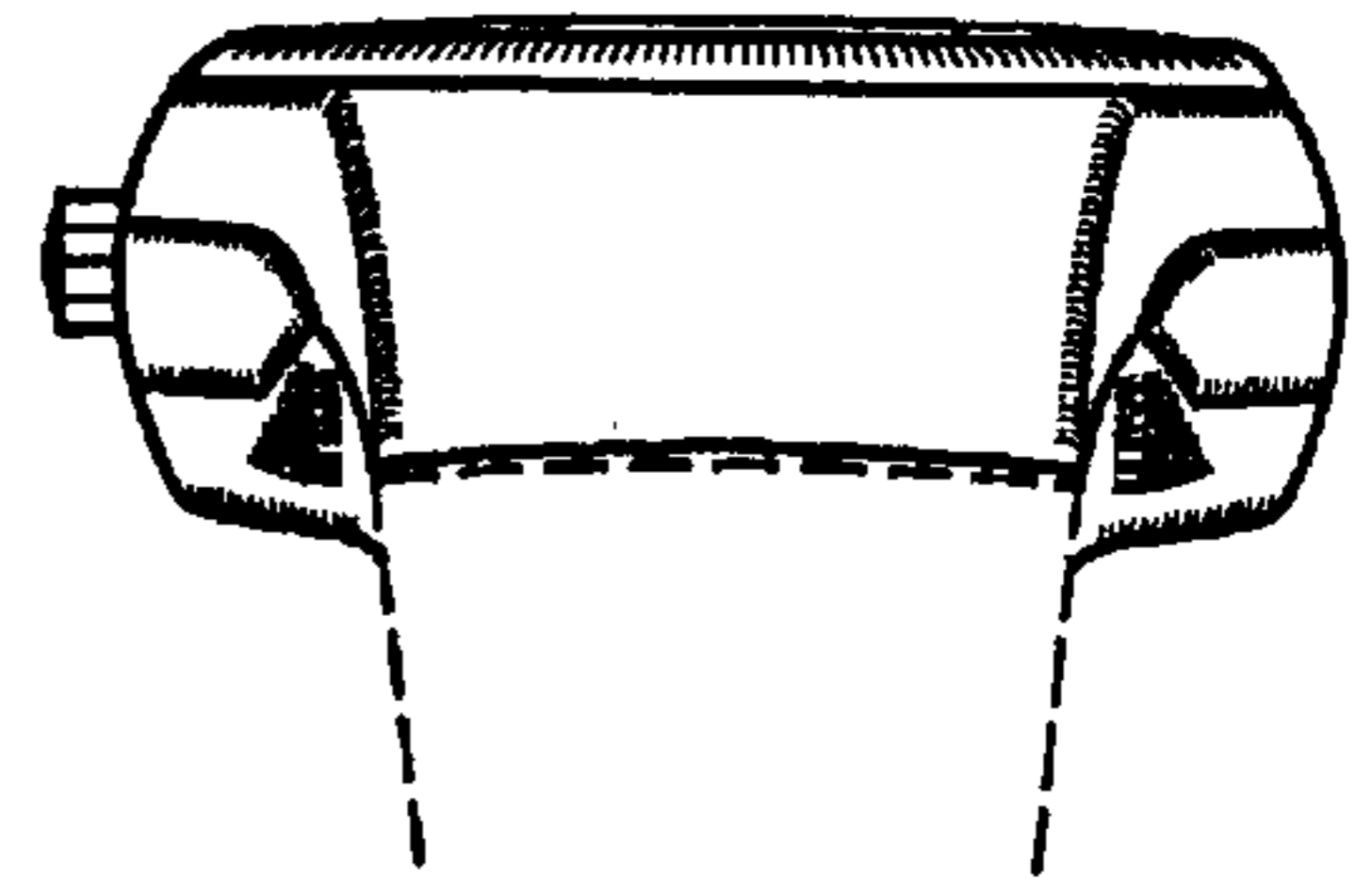

FIG. 14

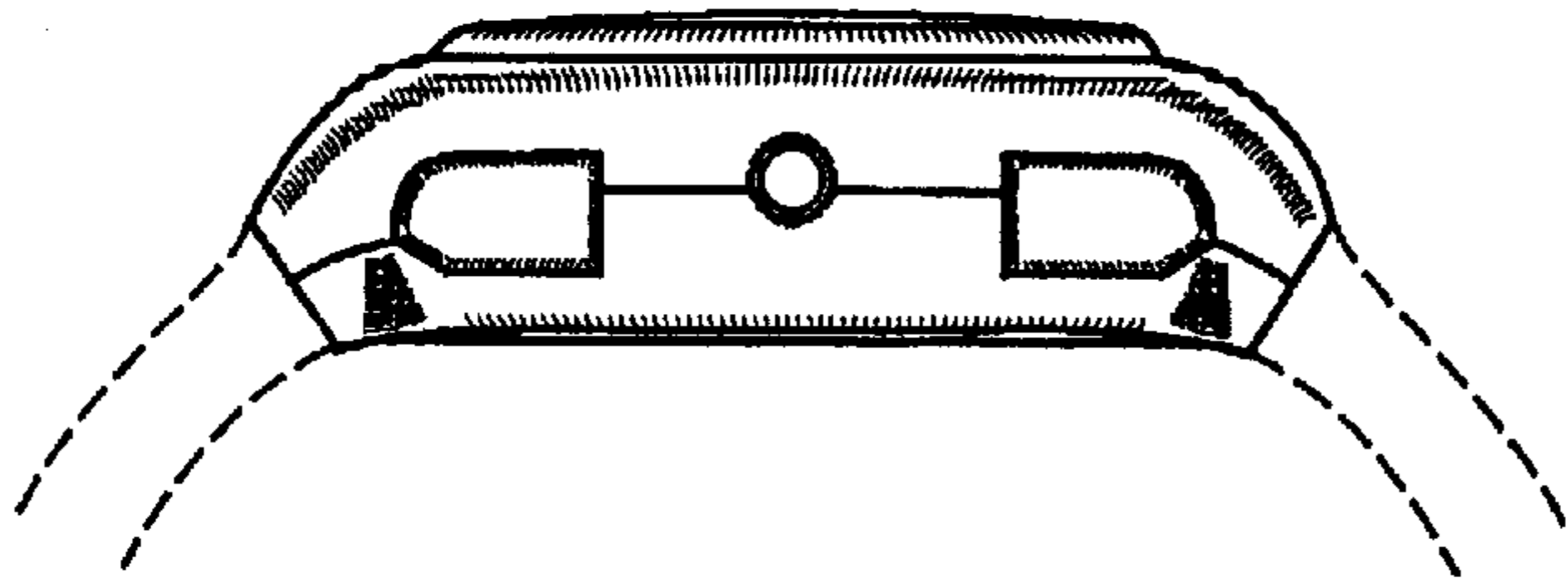

FIG. 15

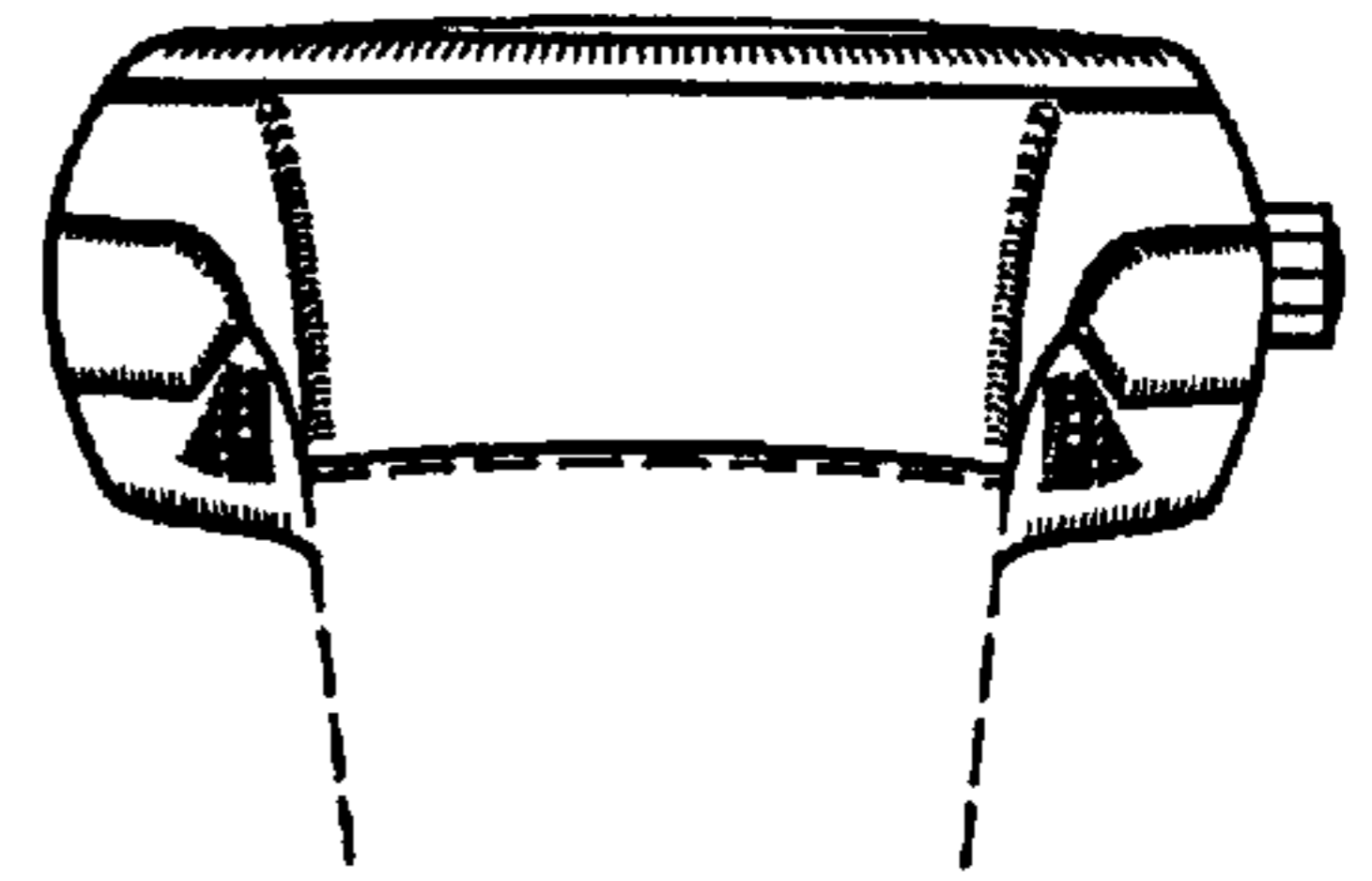

FIG. 16

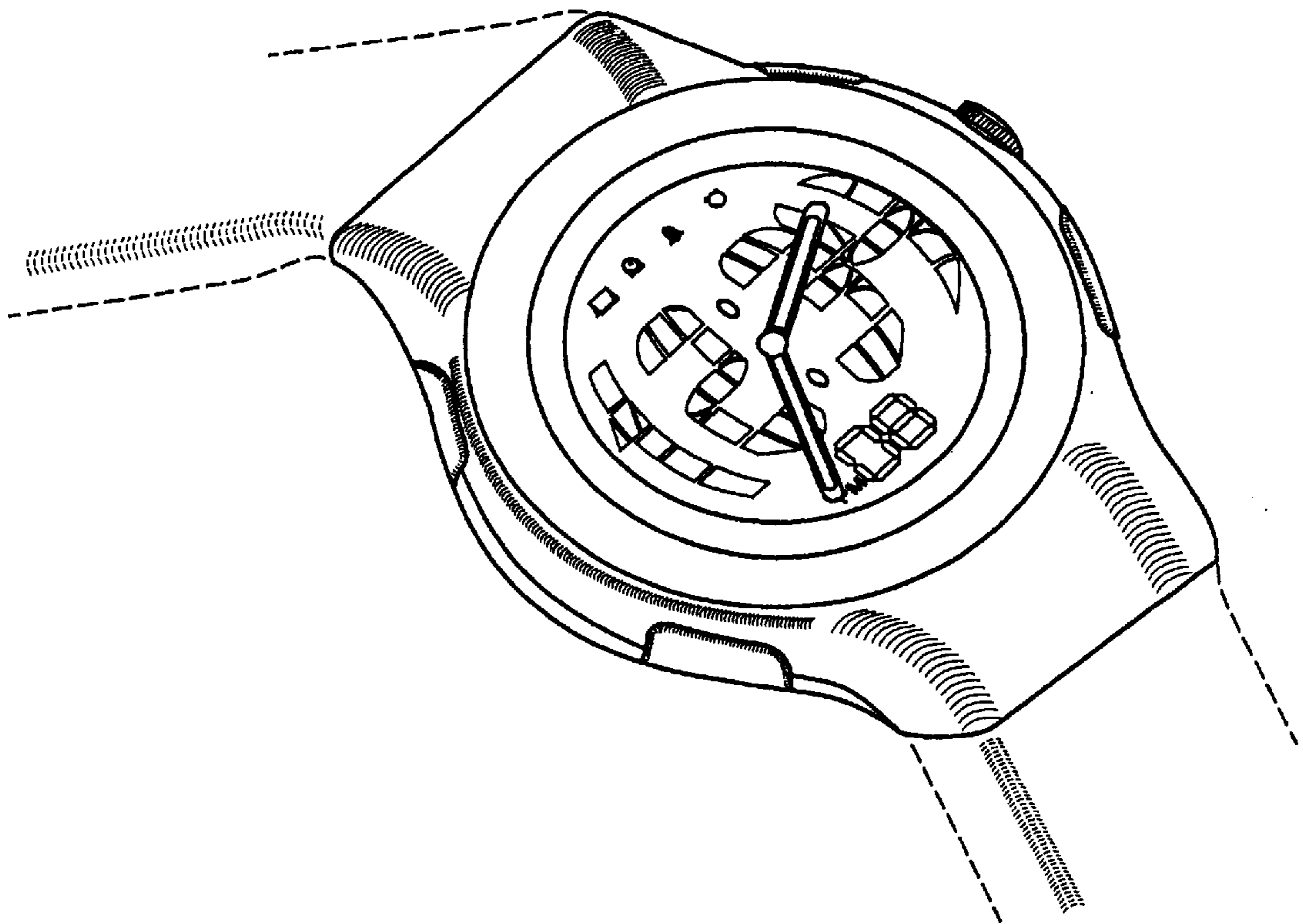

FIG. 17