



US00D435425S

United States Patent [19]

Roesler et al.

[11] Patent Number: Des. 435,425

[45] Date of Patent: ** Dec. 26, 2000

[54] **KNOB FOR A PERSONAL SECURITY DEVICE**

[75] Inventors: **Ronald A. Roesler**, Bellevue, Wash.; **Peter H. Jederman**, Richmond, Canada; **Virgil E. Pound**, Issaquah, Wash.

[73] Assignee: **Gateway Marketing Corporation**, Bellevue, Wash.

[**] Term: **14 Years**

[21] Appl. No.: **29/119,368**

[22] Filed: **Feb. 28, 2000**

[51] **LOC (7) Cl.** **08-06**

[52] **U.S. Cl.** **D8/310**

[58] **Field of Search** D8/307, 310, 330, D8/331, 343; 16/414, 417, 441; 292/289, 293, 294, 339, 258; 70/209-11, 225-6, 227, 228, 238, 252, 431

[56] **References Cited**

U.S. PATENT DOCUMENTS

4,078,835	3/1978	Spencer	292/258
4,285,535	8/1981	Leary	292/293
5,135,272	8/1992	Centofante	292/293
5,566,993	10/1996	Olivas	292/293
5,887,464	3/1999	Perez	70/209

OTHER PUBLICATIONS

Paul Associates Cat; p. 61; Knobs 301, 1105m, 580, Sep. 2, 1983.

Primary Examiner—B. J. Bullock

Attorney, Agent, or Firm—Kathleen T. Petrich

[57] **CLAIM**

We claim the ornamental design for a knob for a personal security device, as shown and described.

DESCRIPTION

FIG. 1 is a perspective view of the knob for a personal security device showing our new design;

FIG. 2 is a top plan view thereof;

FIG. 3 is a left side view thereof;

FIG. 4 is a front view thereof;

FIG. 5 is a right side view thereof;

FIG. 6 is a bottom plan view thereof;

FIG. 7 is a rear view thereof;

FIG. 8 is a perspective view of an alternate embodiment of the present invention;

FIG. 9 is a front view of the alternate view of FIG. 8, where the top plan view, left side view, right side view, bottom plan view, and rear view are all the same as for the first embodiment; and,

FIG. 10 is a reduced perspective view of the knob for a personal security device of the first embodiment connected to a personal security device shown in phantom. The broken line drawing of the personal security device is shown for illustrative purposes only and forms no part of the claimed design.

1 Claim, 2 Drawing Sheets

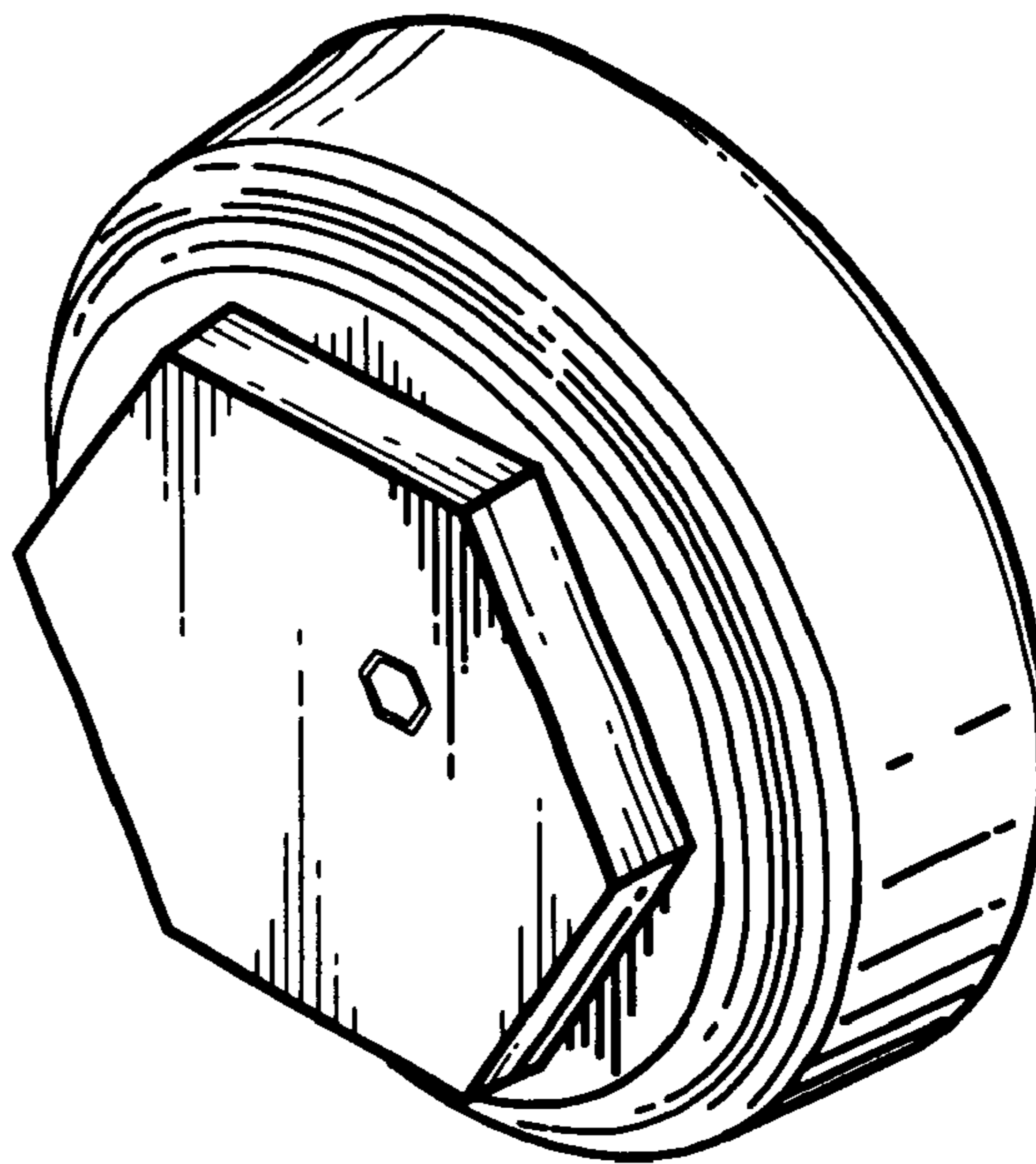
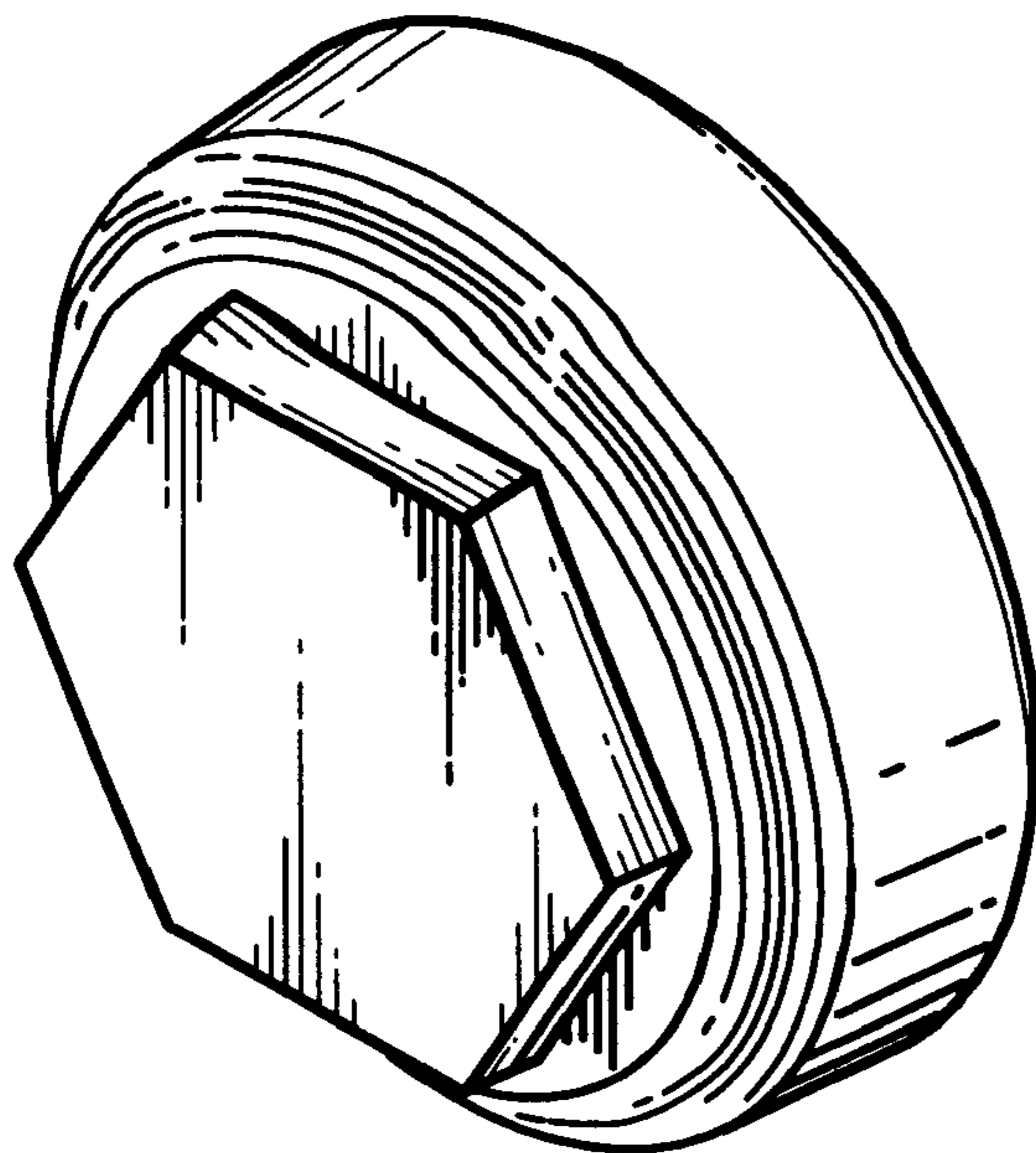

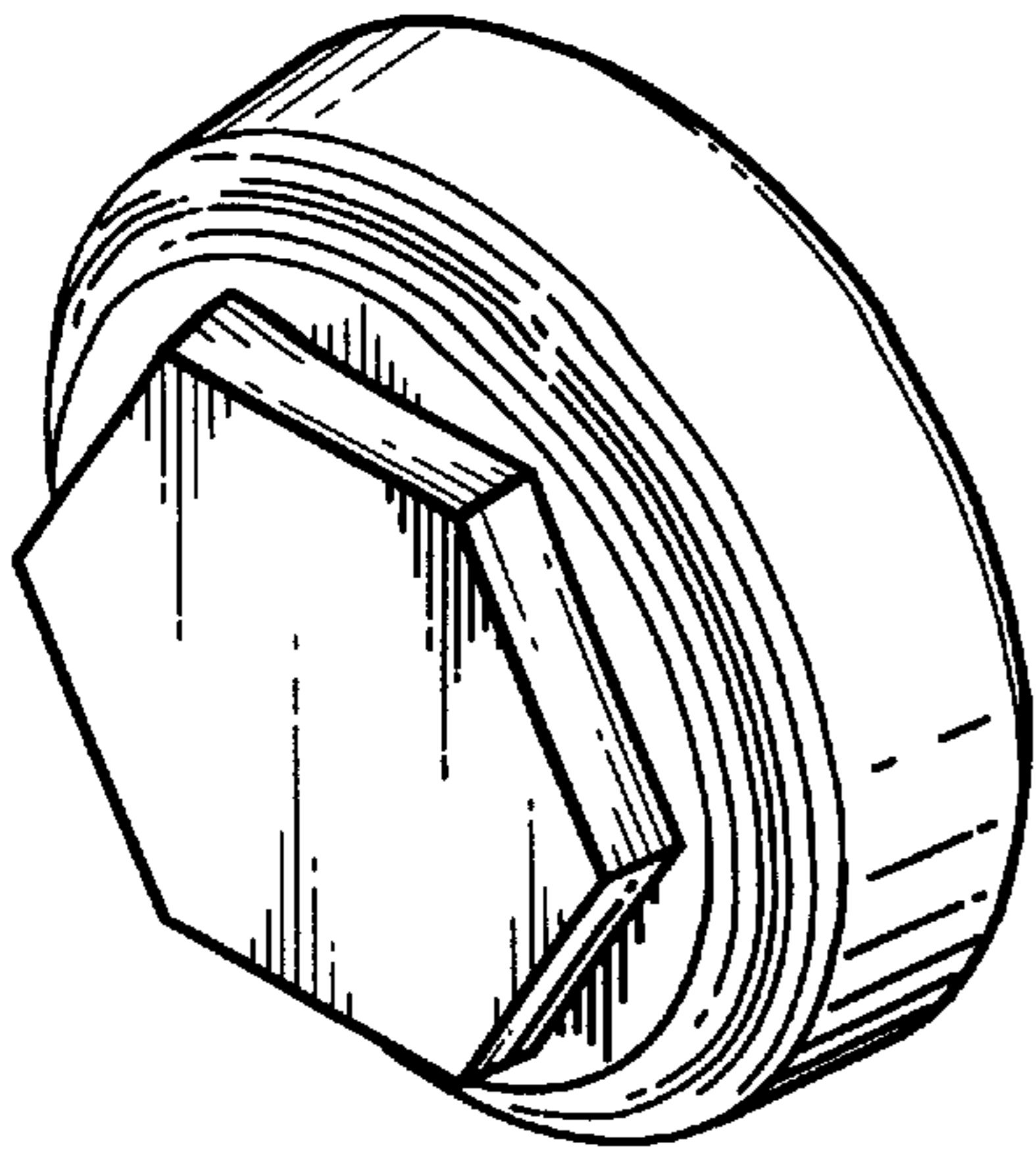

Fig. 1

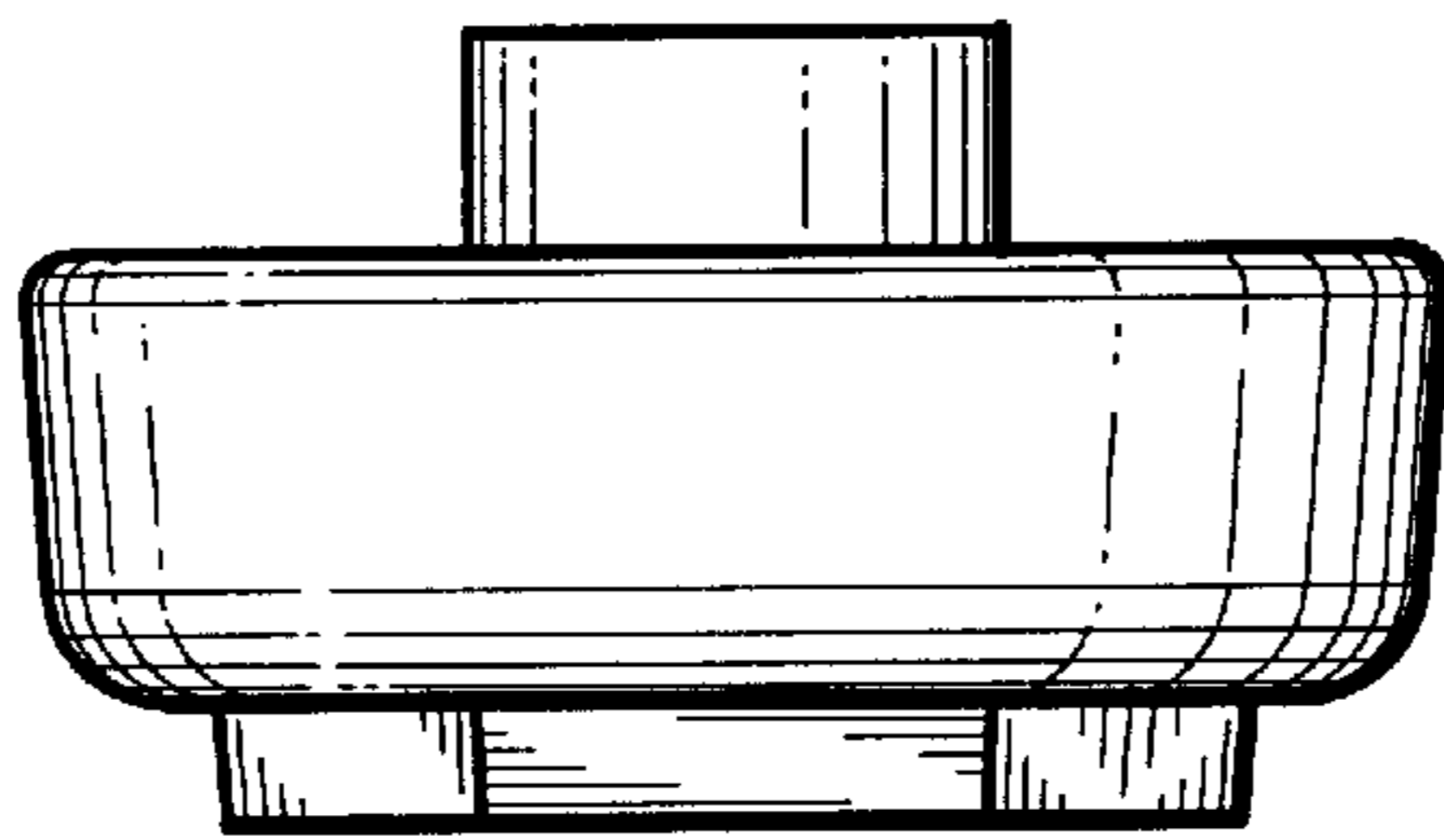

Fig. 2

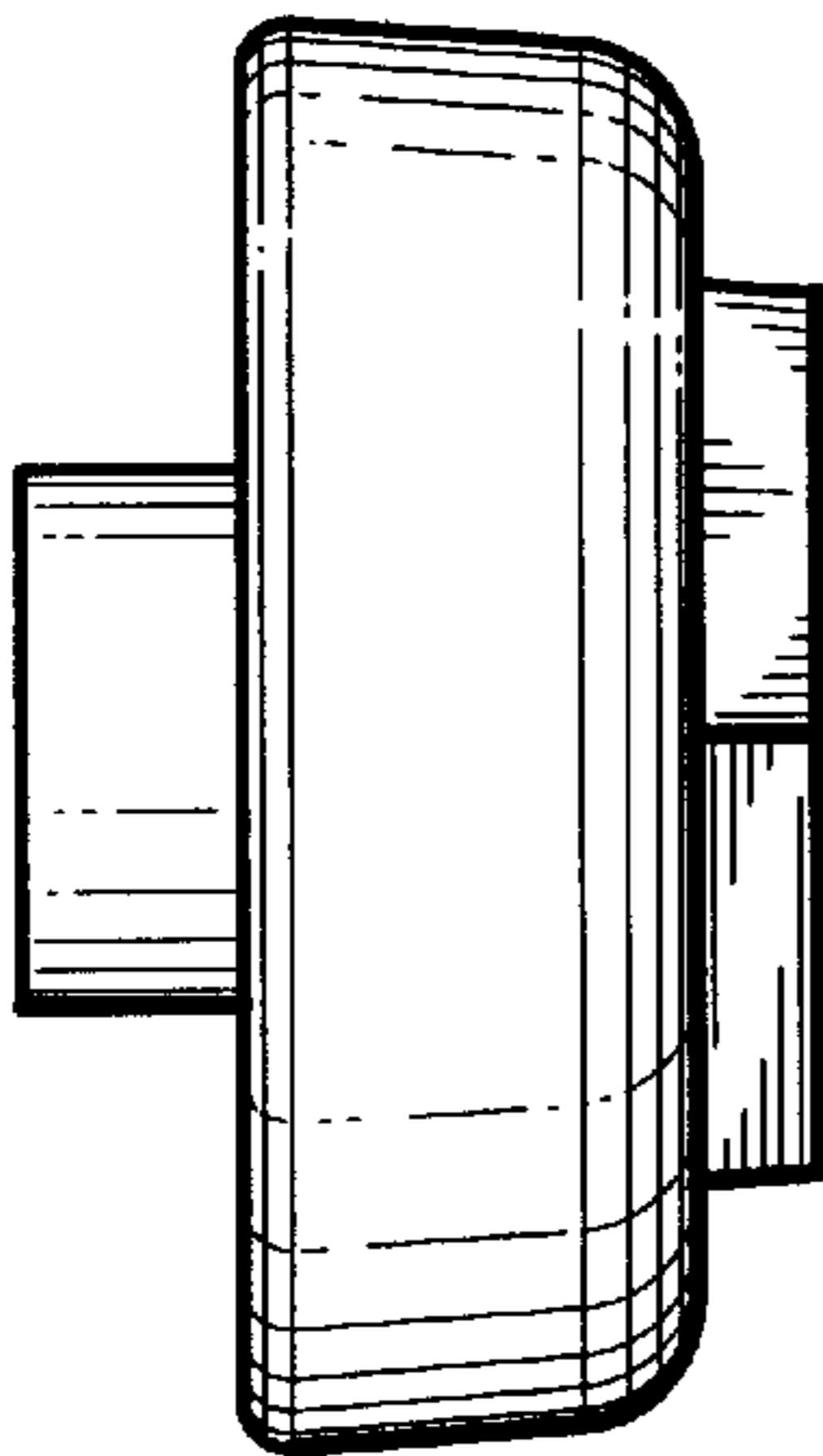

Fig. 3

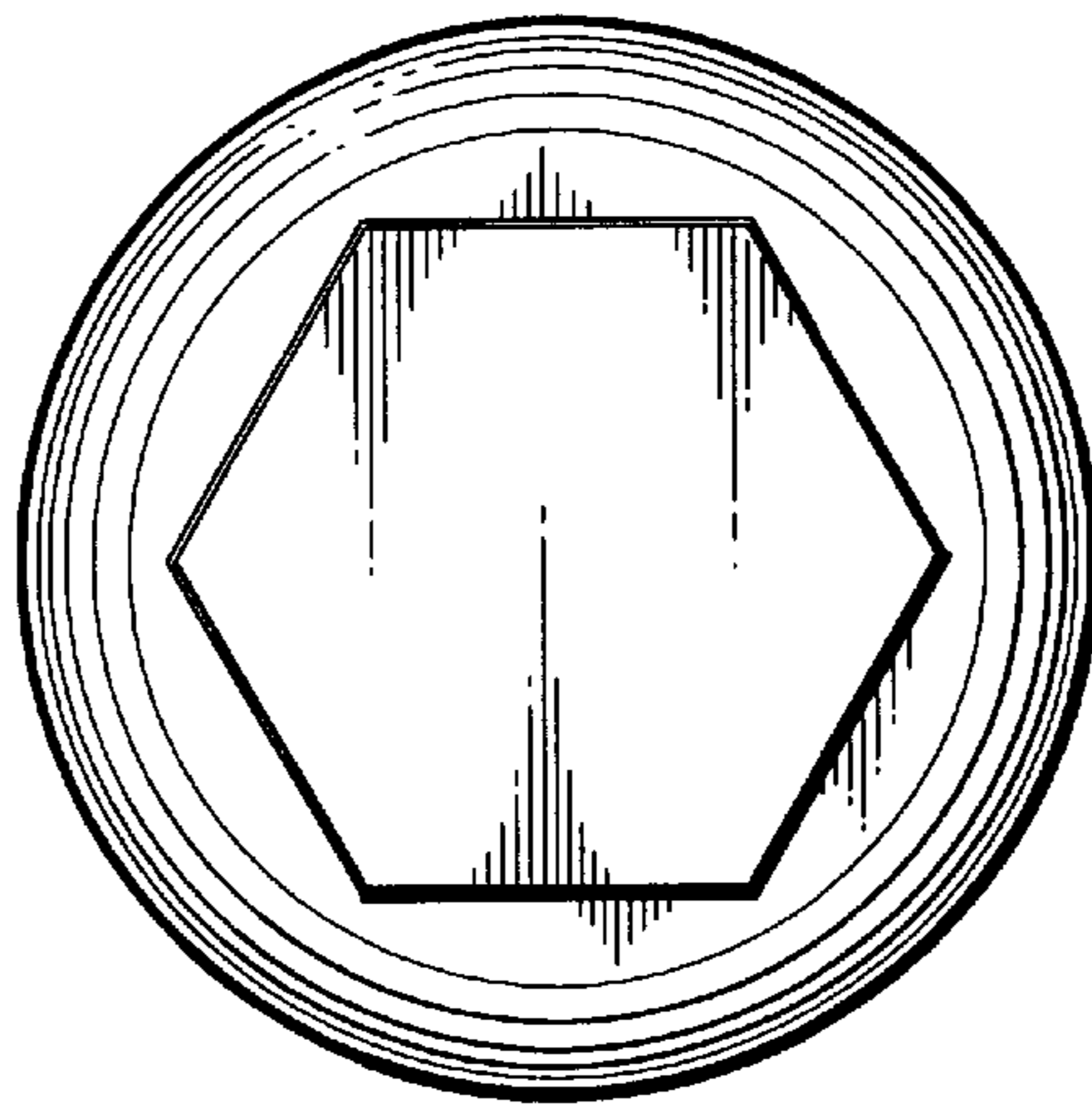

Fig. 4

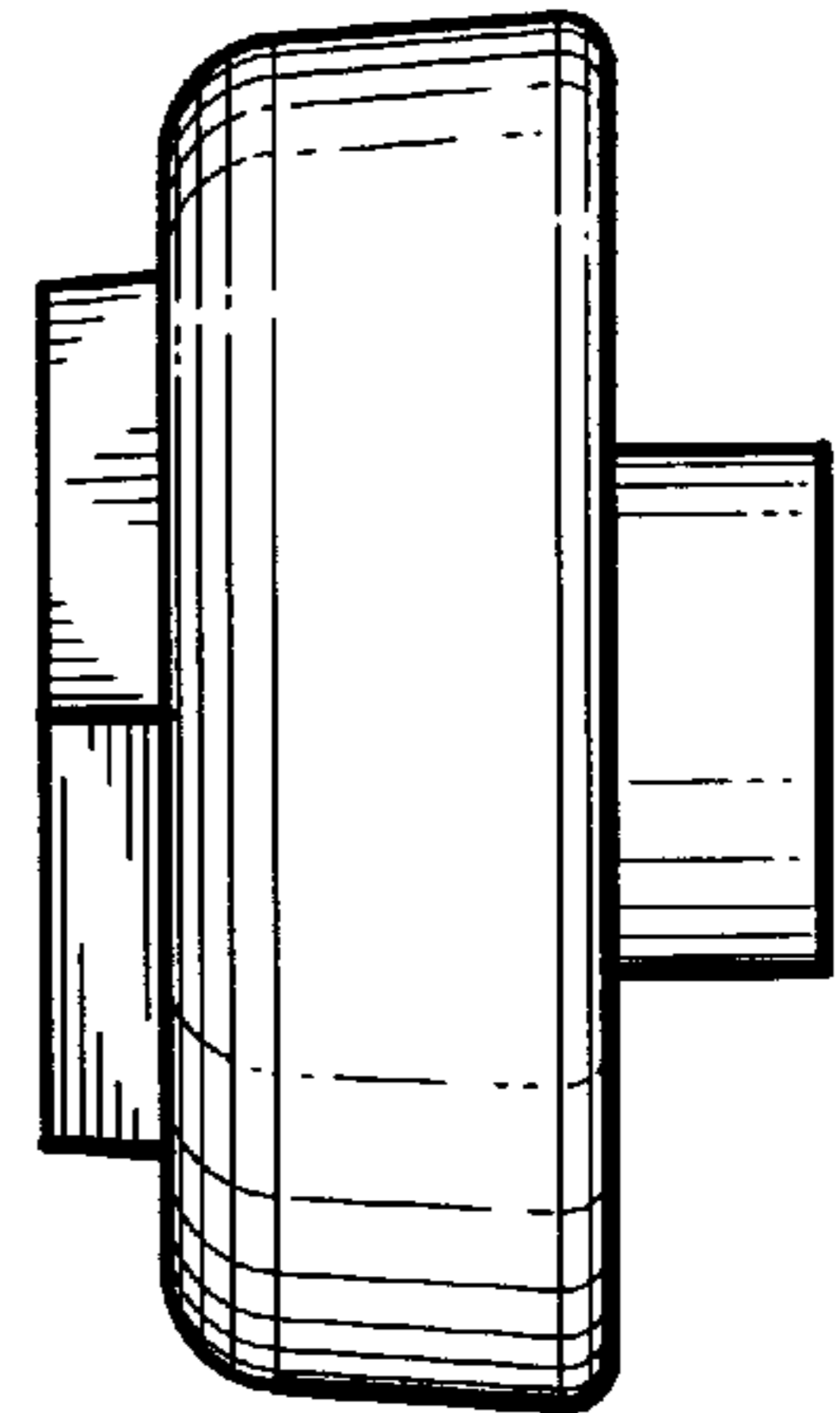

Fig. 5

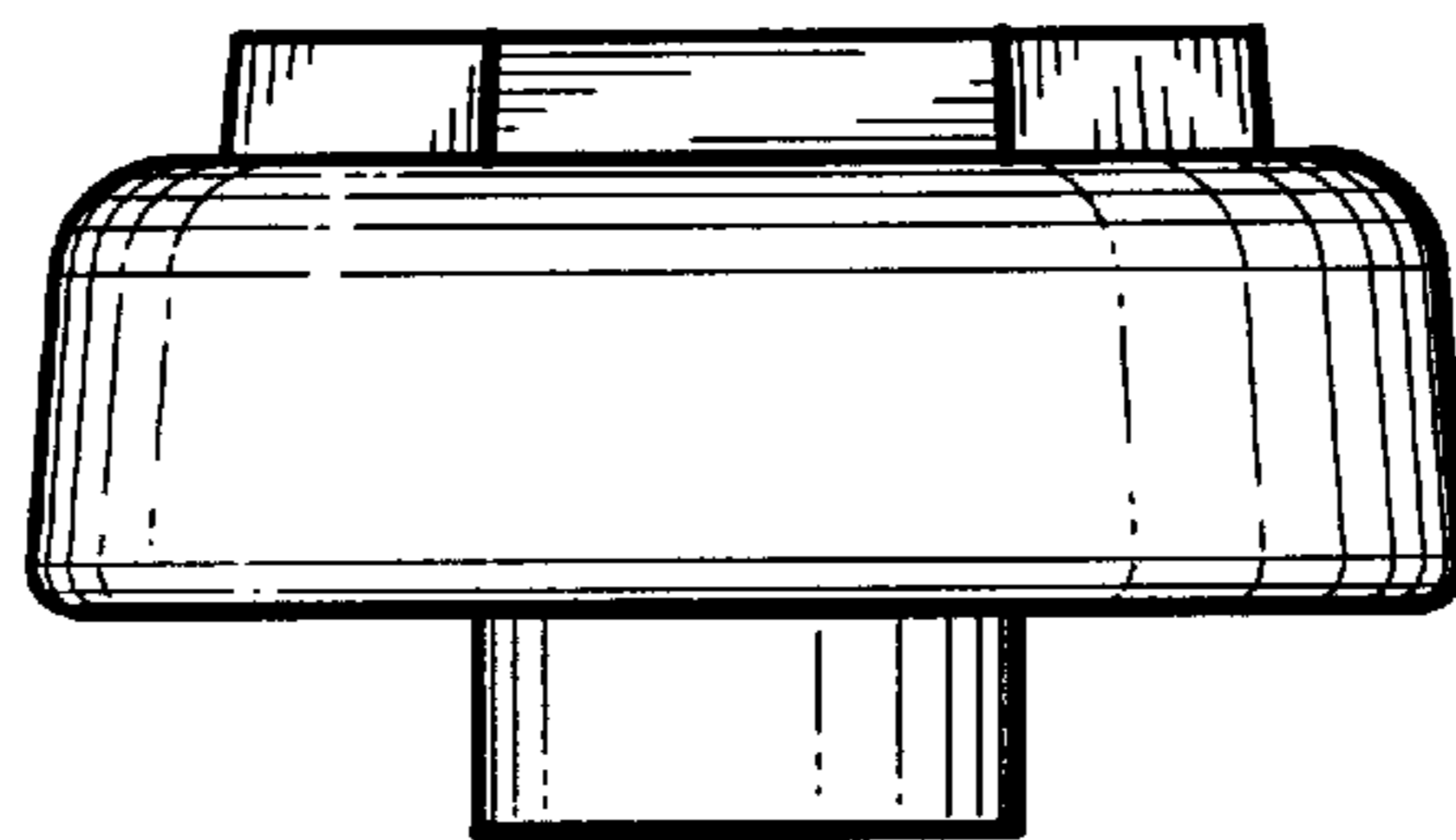

Fig. 6

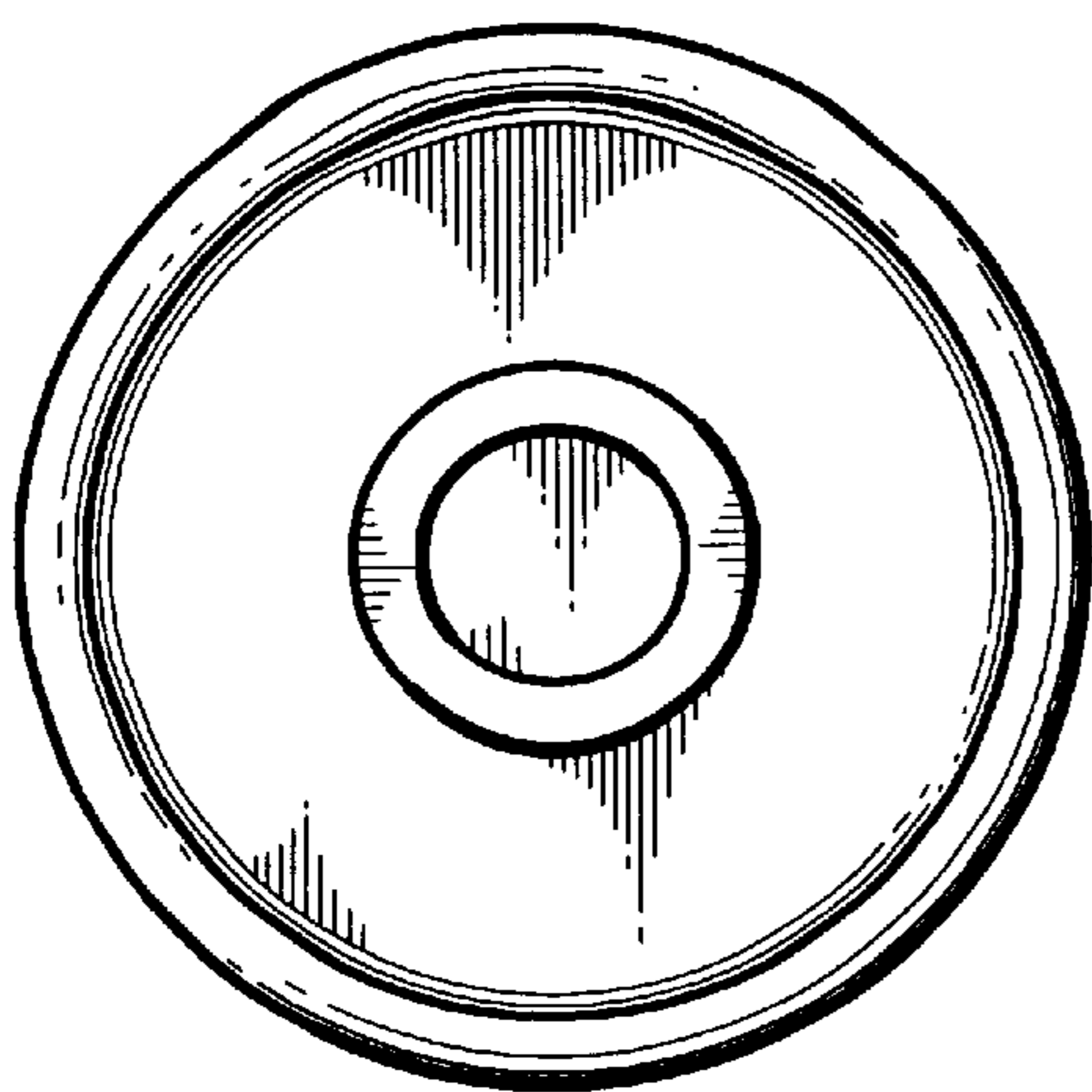

Fig. 7

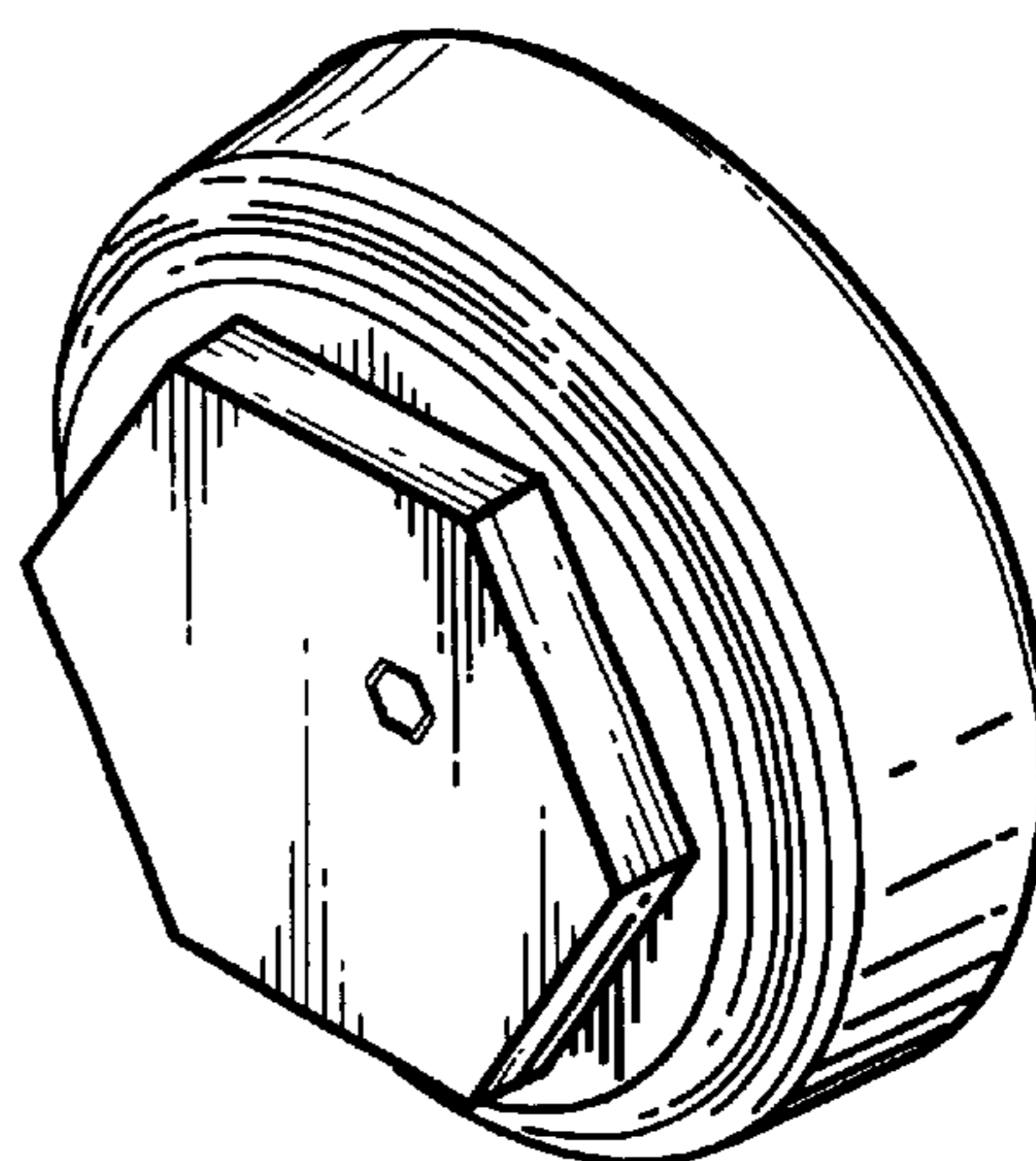

Fig. 8

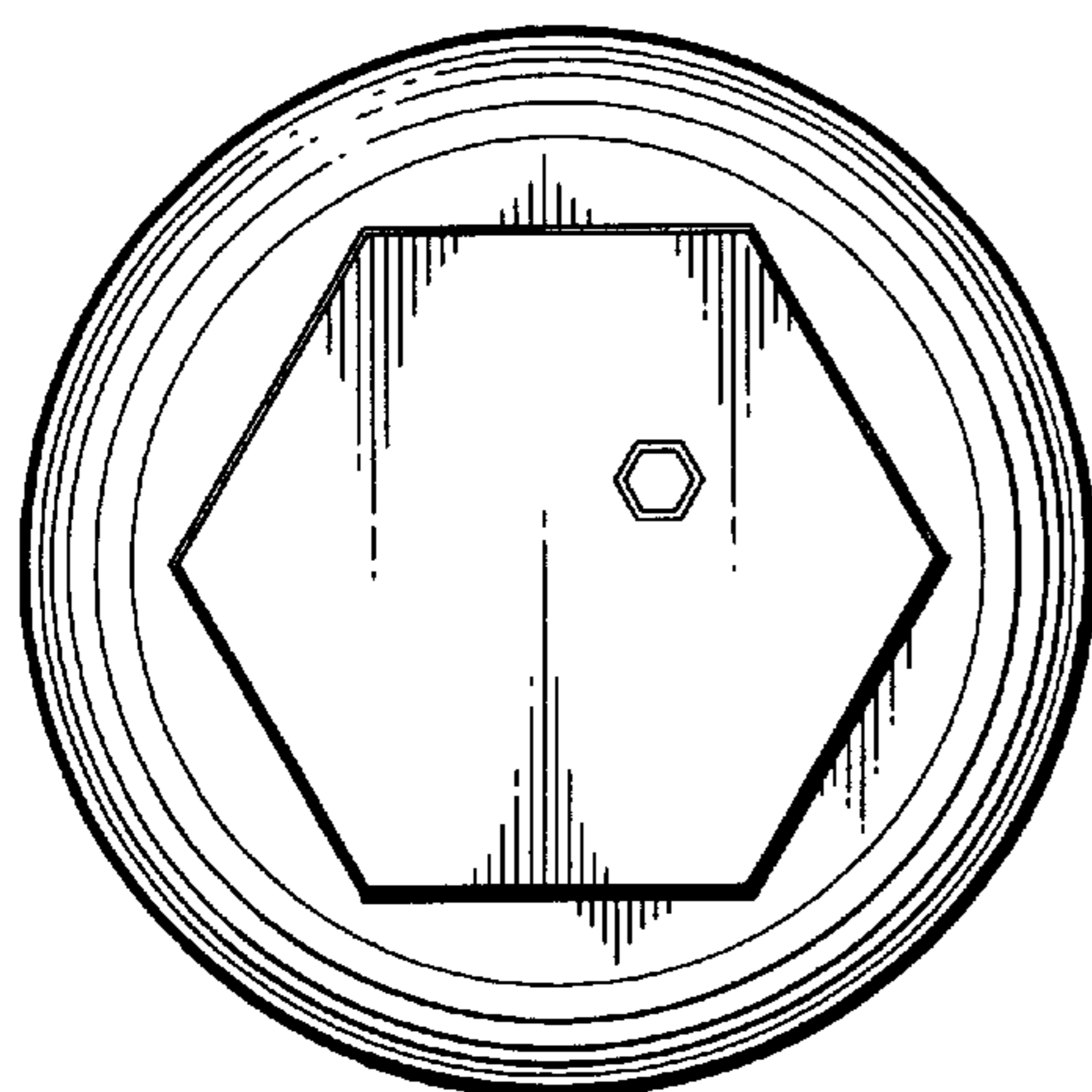

Fig. 9

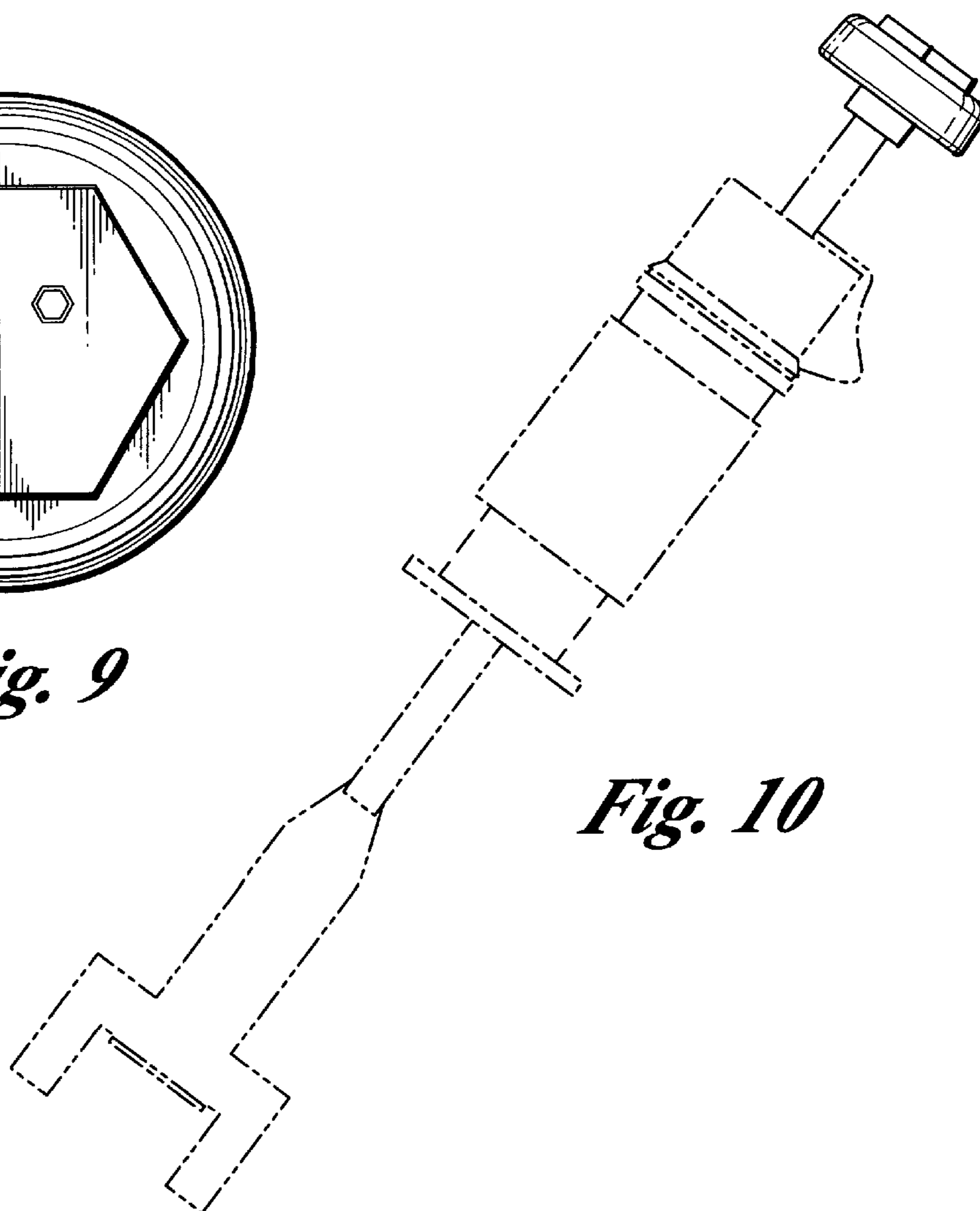

Fig. 10