



US00D435346S

**United States Patent** [19]  
**Safieh**

[11] **Patent Number: Des. 435,346**

[45] **Date of Patent: \*\* Dec. 26, 2000**

[54] **INFANT TOOTHBRUSH**

[76] Inventor: **Eric Safieh**, 389 Silverstone Drive,  
Rexdale, Ontario, Canada, M9V 3K3

[\*\*] Term: **14 Years**

[21] Appl. No.: **29/105,915**

[22] Filed: **Jun. 2, 1999**

[51] **LOC (7) Cl.** ..... **04-02**

[52] **U.S. Cl.** ..... **D4/107**

[58] **Field of Search** ..... D4/103-112, 127,  
D4/132, 134; D24/194-196; 15/159.1, 160,  
167.1, 186-188, 191.1, 110; 215/11.1; 606/234-236;  
601/139, 141

[56] **References Cited**

**U.S. PATENT DOCUMENTS**

D. 313,317	1/1991	Brunner et al.	.....	D4/103
3,753,266	8/1973	Ceniceros	.....	15/110
5,571,140	11/1996	Gura-Emerling	.....	606/236
5,711,759	1/1998	Smith et al.	.....	601/139
5,729,859	3/1998	Guffin, III	.....	15/167.1

**FOREIGN PATENT DOCUMENTS**

2067069 7/1981 United Kingdom .

*Primary Examiner*—Alan P. Douglas  
*Assistant Examiner*—Lavone Tabor  
*Attorney, Agent, or Firm*—Merek & Voorhees

[57] **CLAIM**

The ornamental design for an infant toothbrush, as shown and described.

**DESCRIPTION**

FIG. 1 is an upper side perspective of the infant toothbrush; FIG. 2 is a side elevational view thereof; FIG. 3 is a rear elevational view thereof; FIG. 4 is a front elevational view thereof; FIG. 5 is a top plan view thereof; and, FIG. 6 is a side elevational view of the infant toothbrush as it may be secured to a baby bottle.

The side not shown in drawing is a mirror image of the side that is shown in FIG. 2.

The bottom of the toothbrush forms no part of the claimed design.

The broken lines shown in FIG. 6 are for illustrative purposes only and form no part of the claimed design.

**1 Claim, 3 Drawing Sheets**

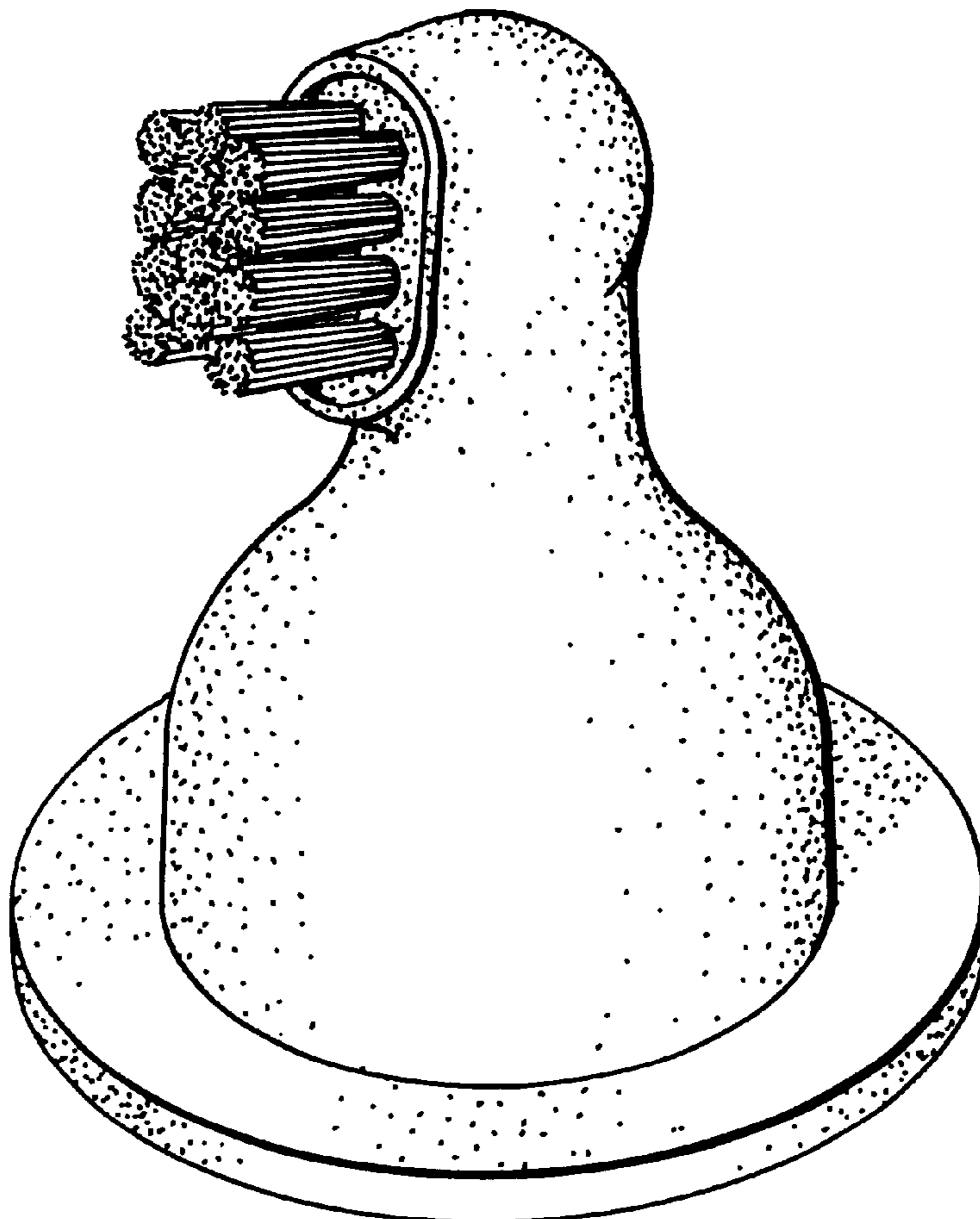

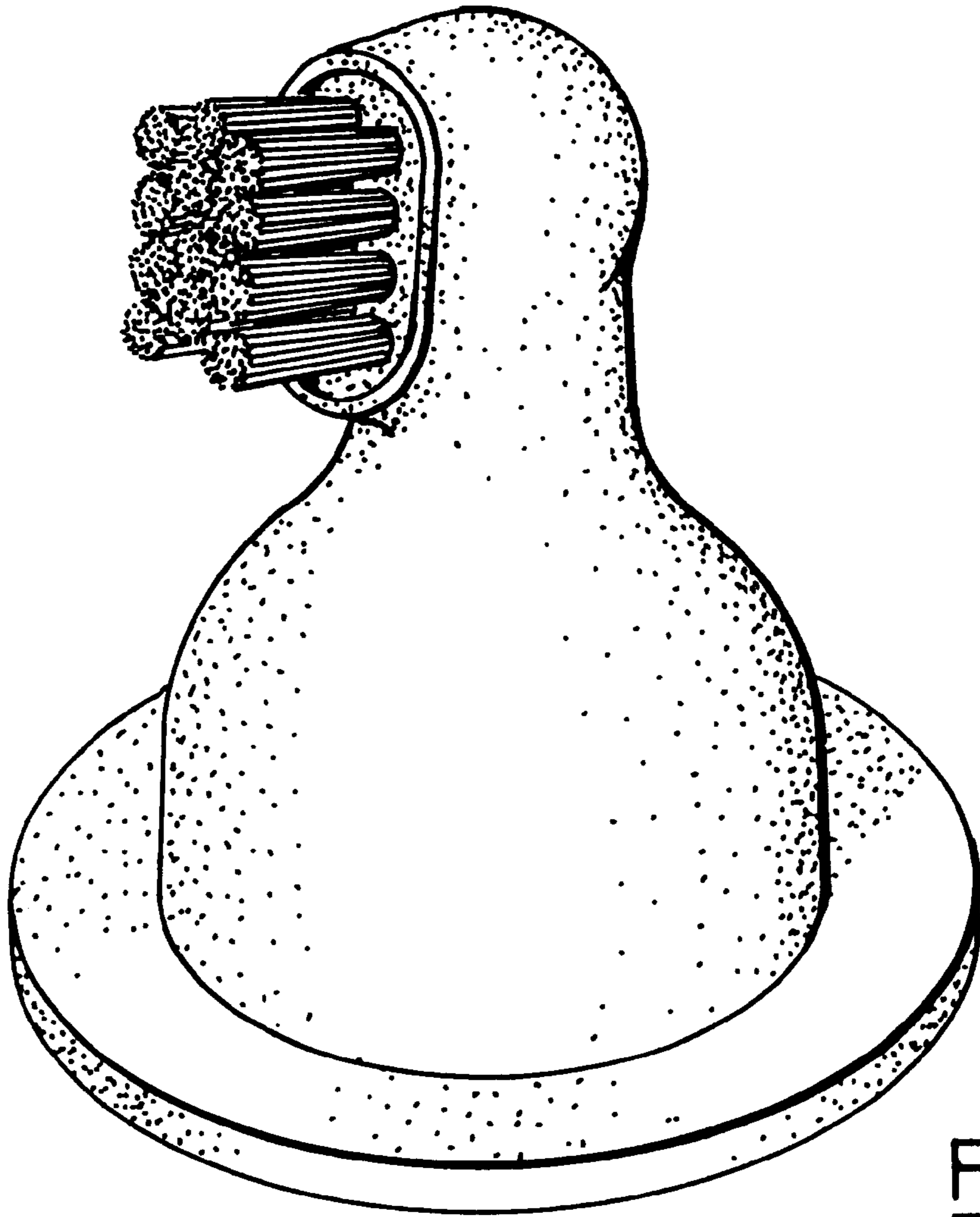
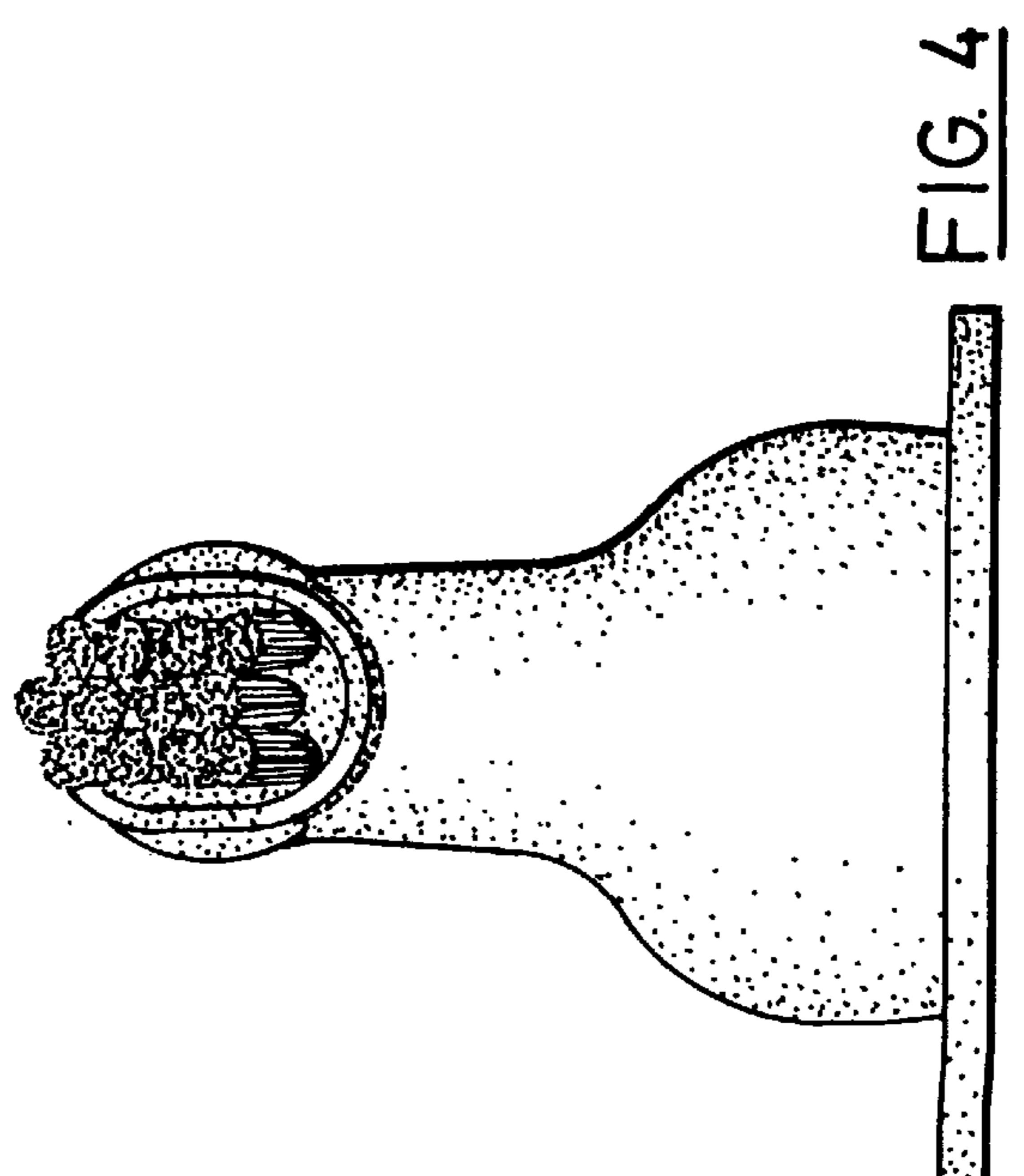
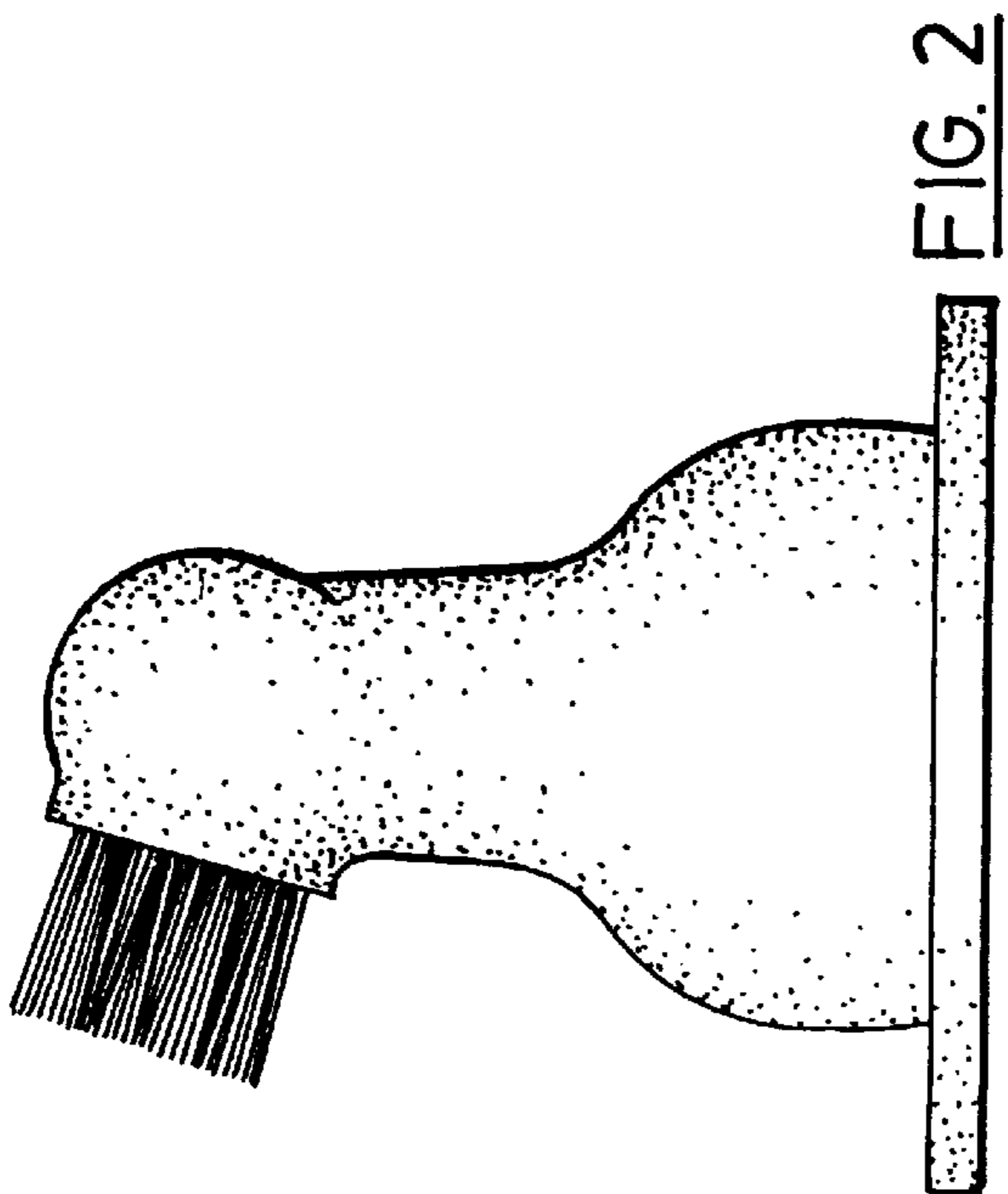
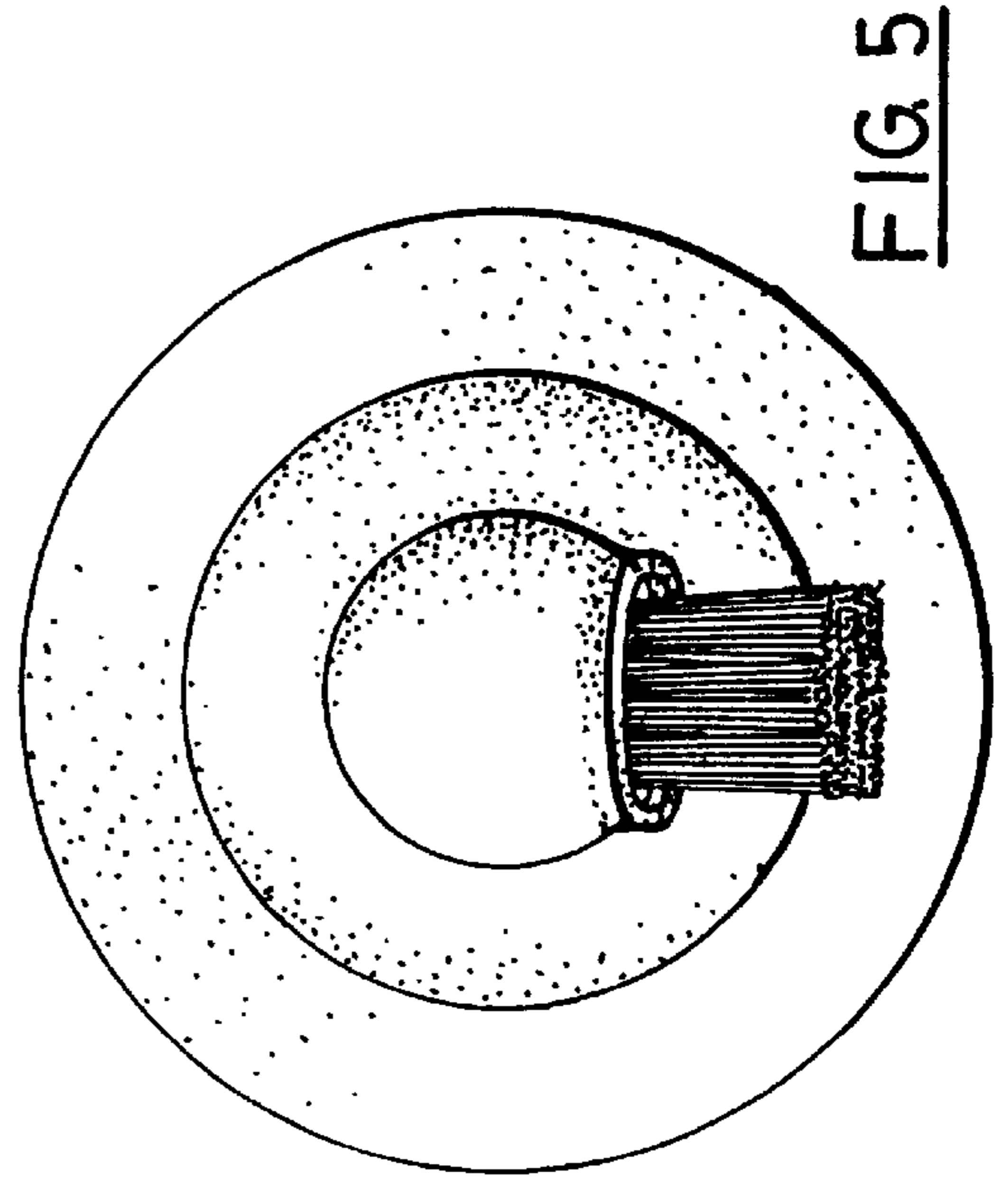
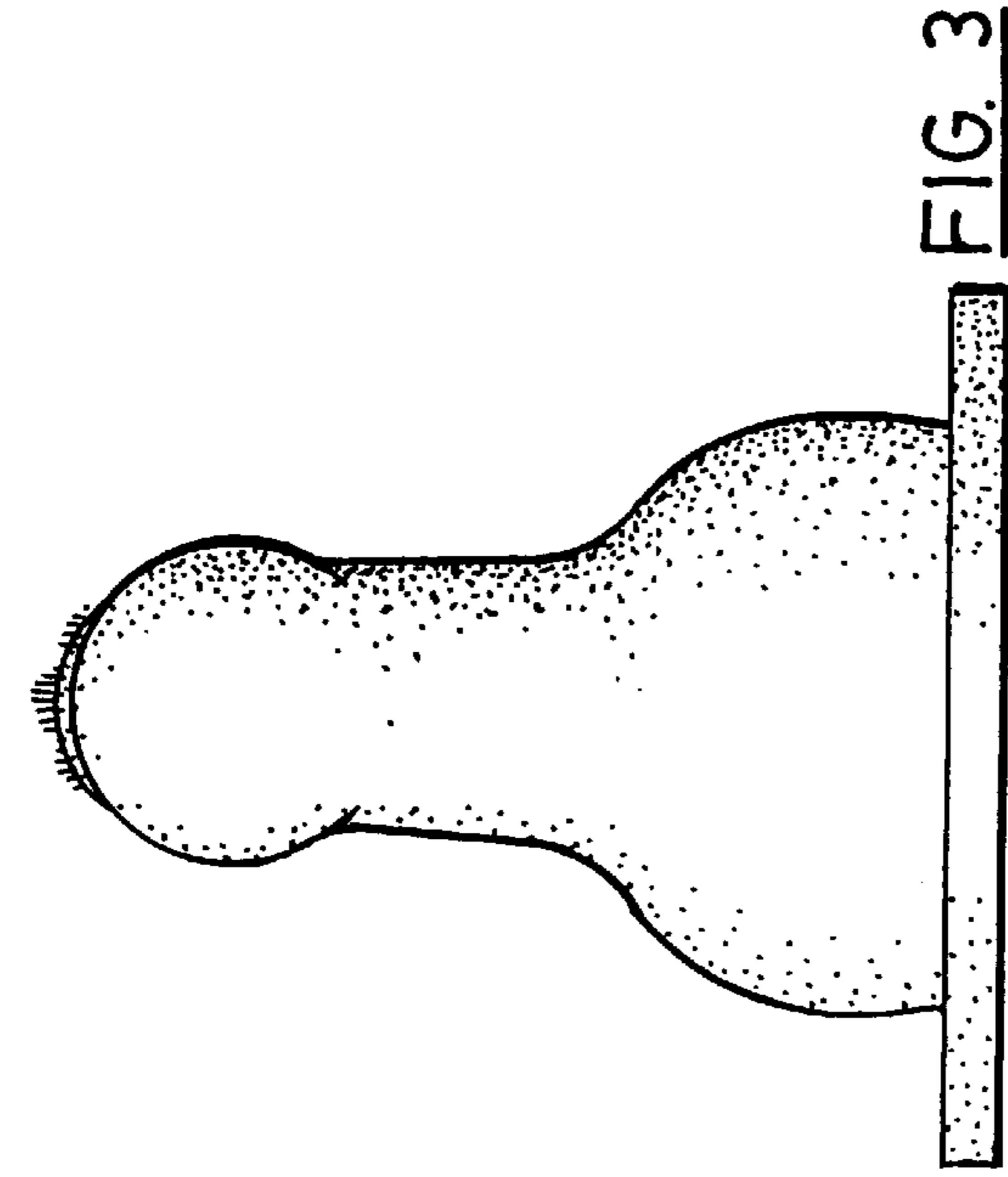

FIG. 1



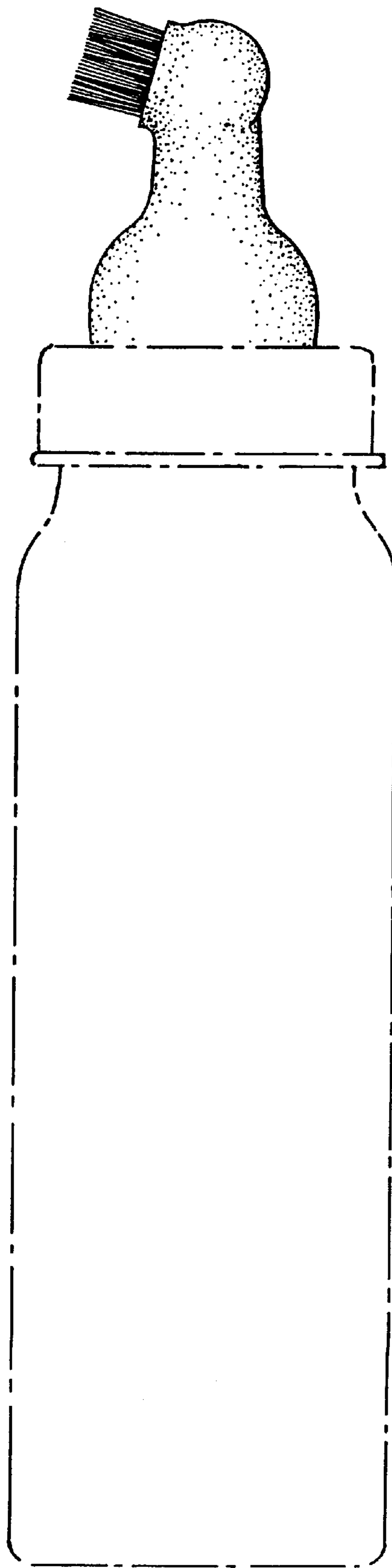

FIG. 6