



US00D435142S

**United States Patent** [19]  
**Lee**

[11] **Patent Number: Des. 435,142**

[45] **Date of Patent: \*\* Dec. 12, 2000**

[54] **CIGARETTE LIGHTER**

[75] Inventor: **Jong-sik Lee**, Inchon, Rep. of Korea

[73] Assignee: **Colibri Corporation**

[\*\*] Term: **14 Years**

[21] Appl. No.: **29/122,137**

[22] Filed: **Apr. 19, 2000**

[51] **LOC (7) Cl.** ..... **27-05**

[52] **U.S. Cl.** ..... **D27/157**

[58] **Field of Search** ..... 431/151, 152,  
431/141, 143, 139, 142, 254, 255, 157,  
159; D27/139, 141, 154, 155, 157, 160

[56] **References Cited**

U.S. PATENT DOCUMENTS

D. 230,424 2/1974 Racek ..... D27/154

*Primary Examiner*—Susan J. Lucas  
*Assistant Examiner*—Jennifer Rivard  
*Attorney, Agent, or Firm*—Salter & Michaelson

[57] **CLAIM**

The ornamental design for a cigarette lighter, as shown.

**DESCRIPTION**

FIG. 1 is a perspective view of a cigarette lighter showing my new design;

FIG. 2 is a side elevational view thereof;

FIG. 3 is an elevational view of the opposite side;

FIG. 4 is a right end view thereof;

FIG. 5 is a left end view thereof;

FIG. 6 is a top plan view thereof;

FIG. 7 is a bottom plan view thereof; and,

FIG. 8 is a perspective view with the lid in an opened position.

**1 Claim, 3 Drawing Sheets**

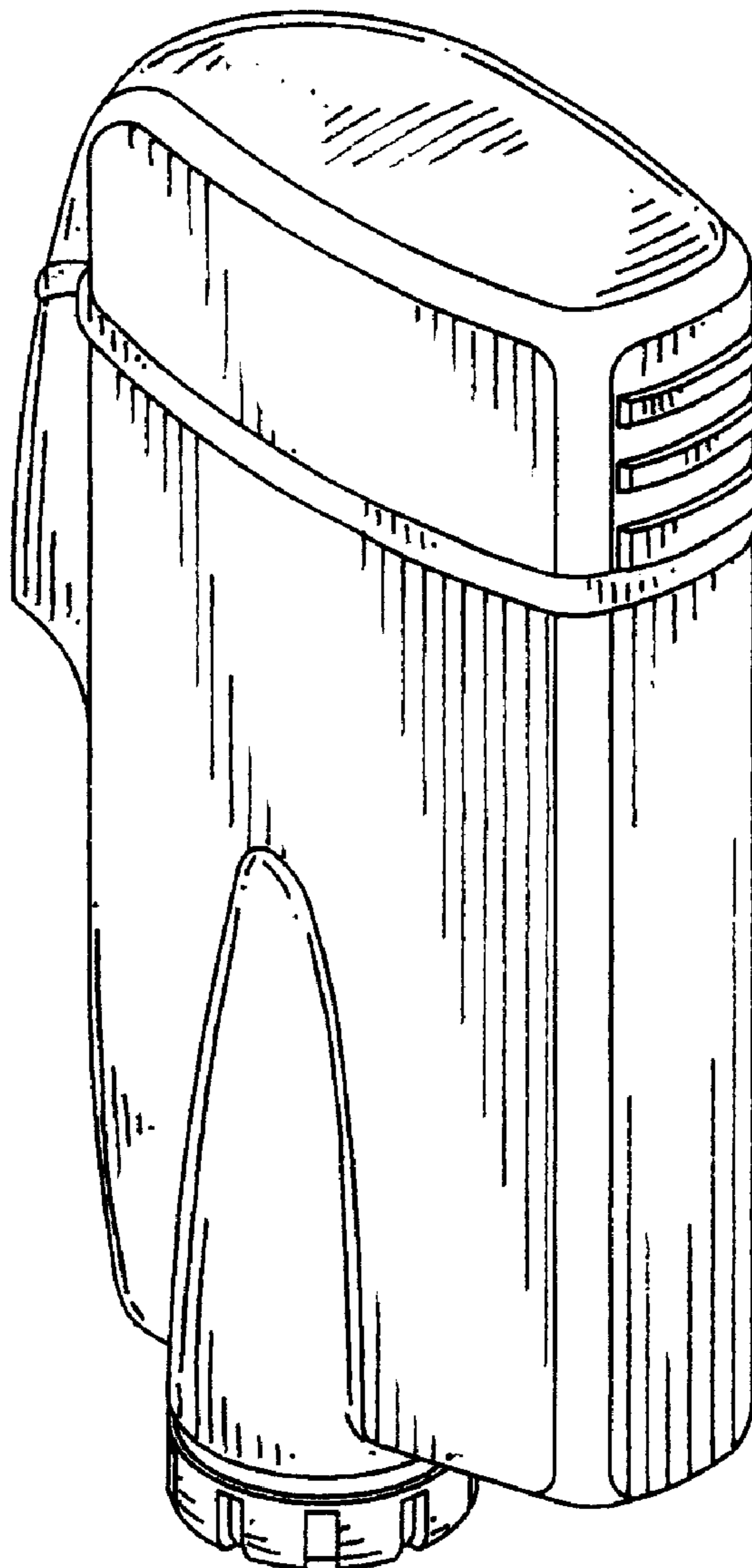

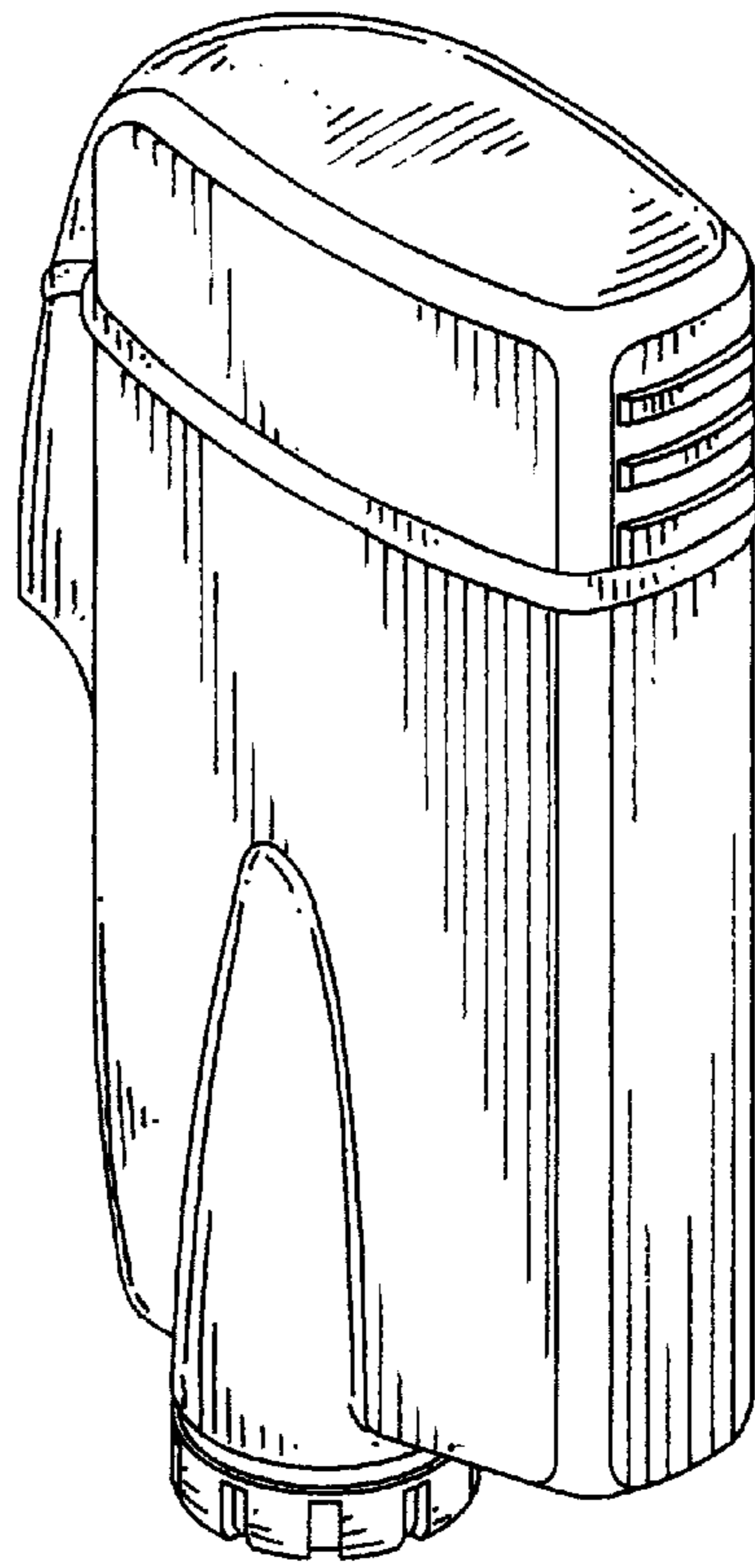

FIG. 1

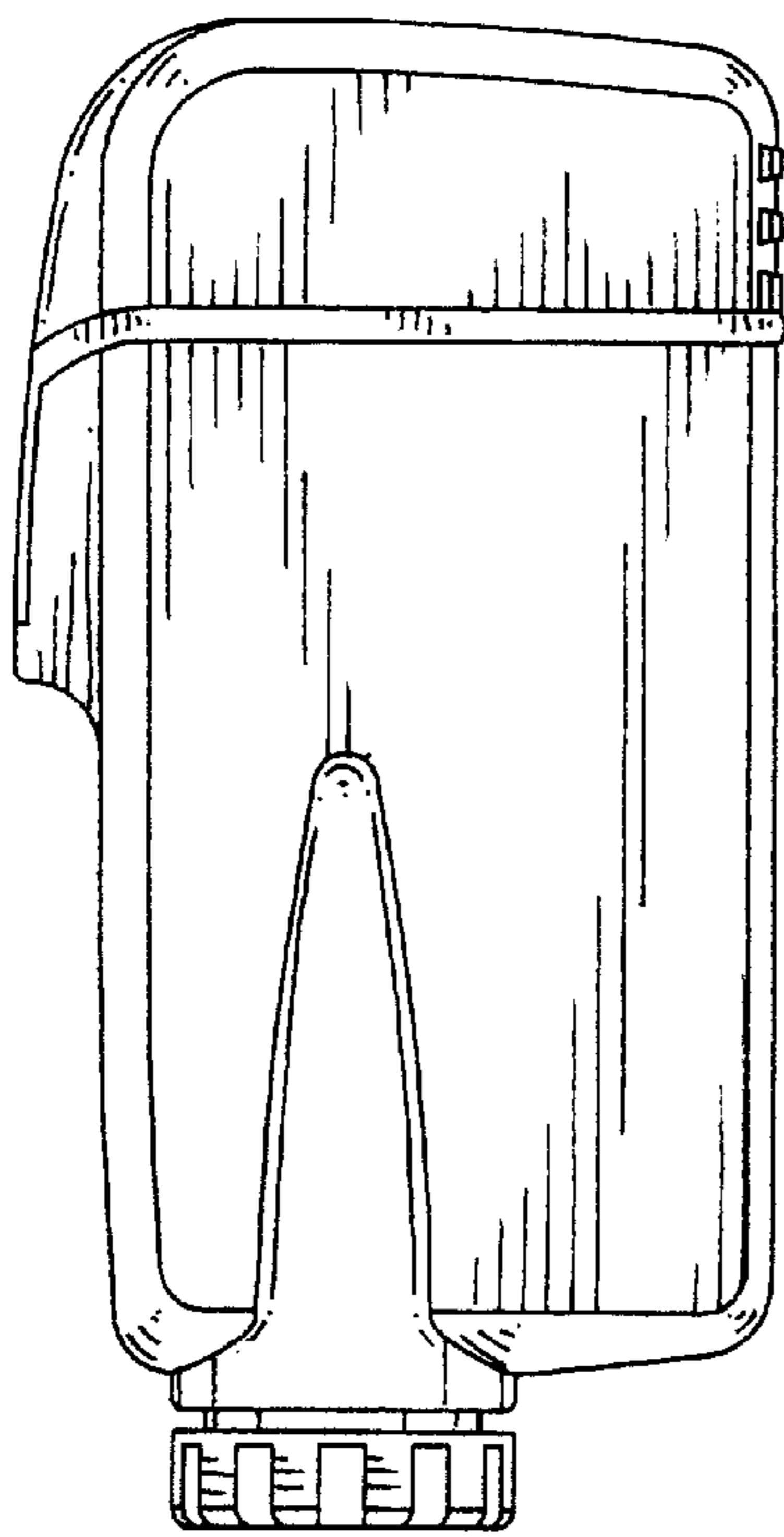

FIG. 2

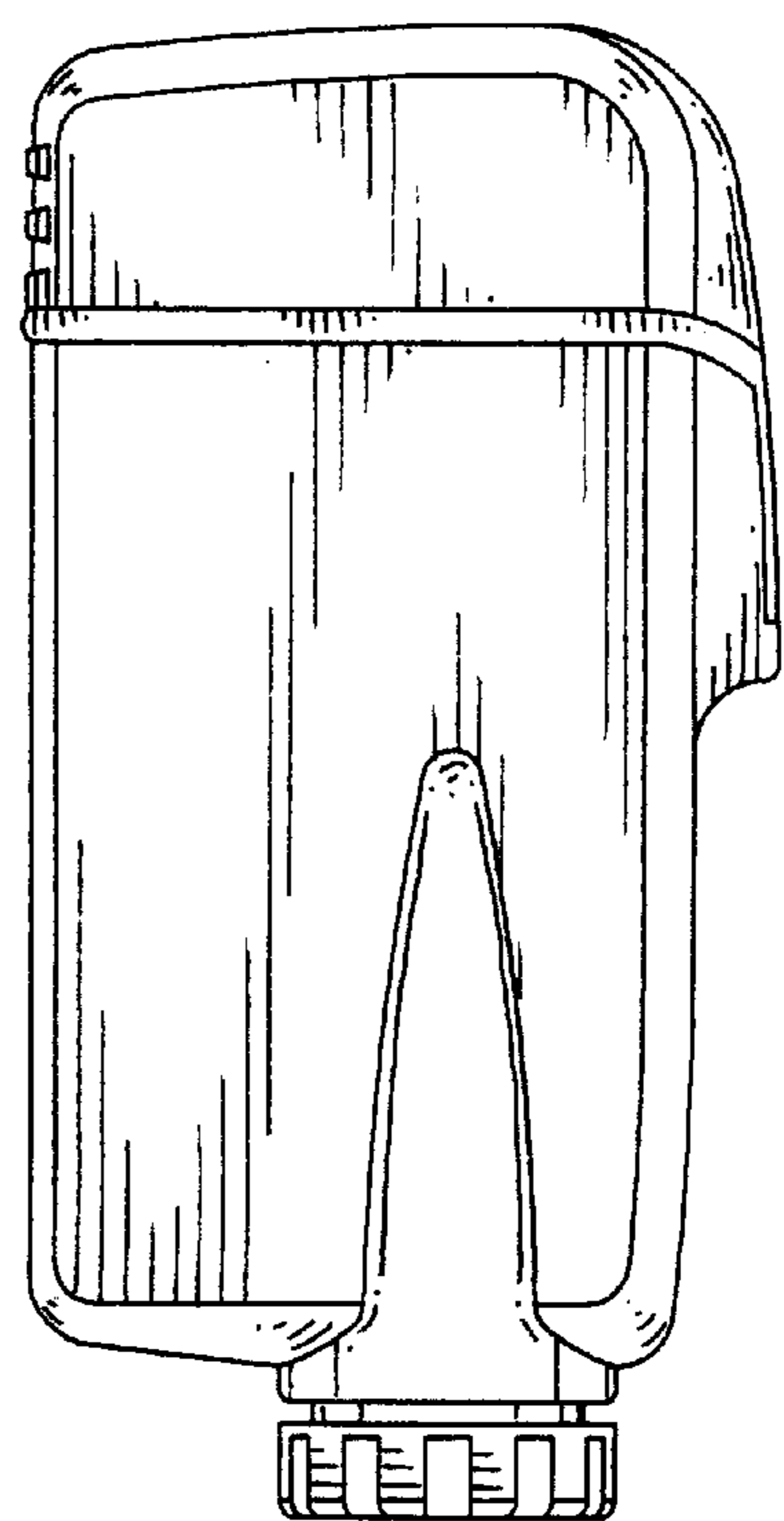

FIG. 3

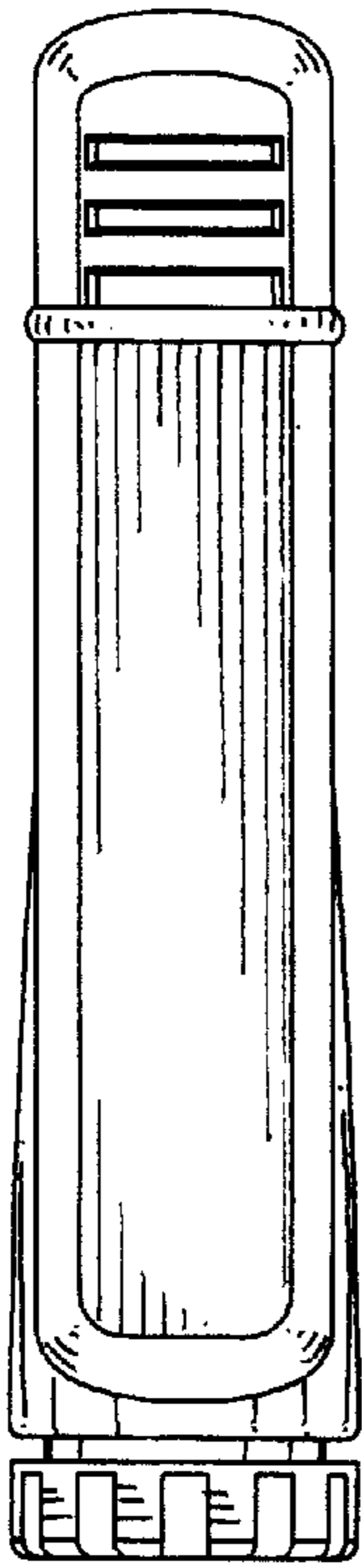

FIG. 4

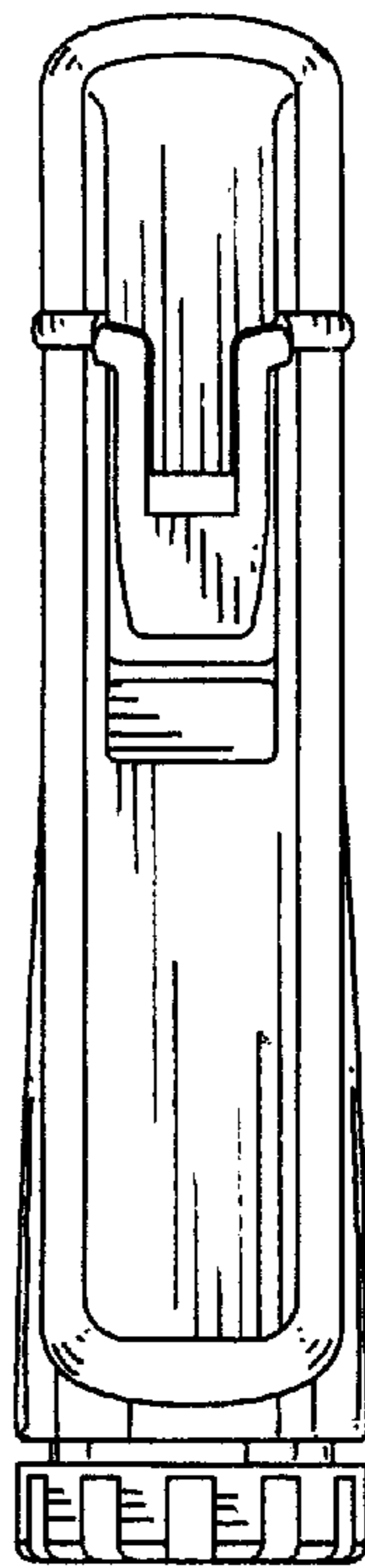

FIG. 5

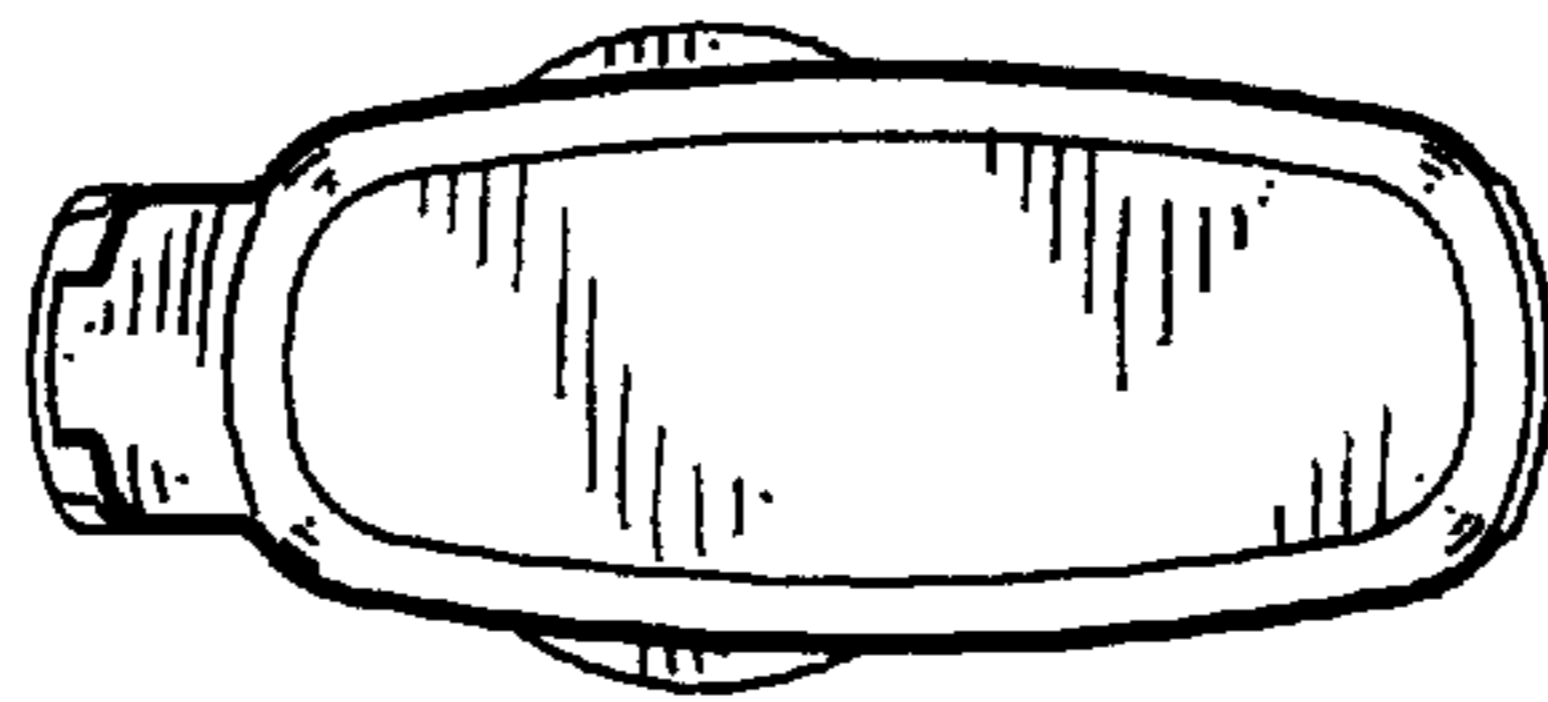

FIG. 6

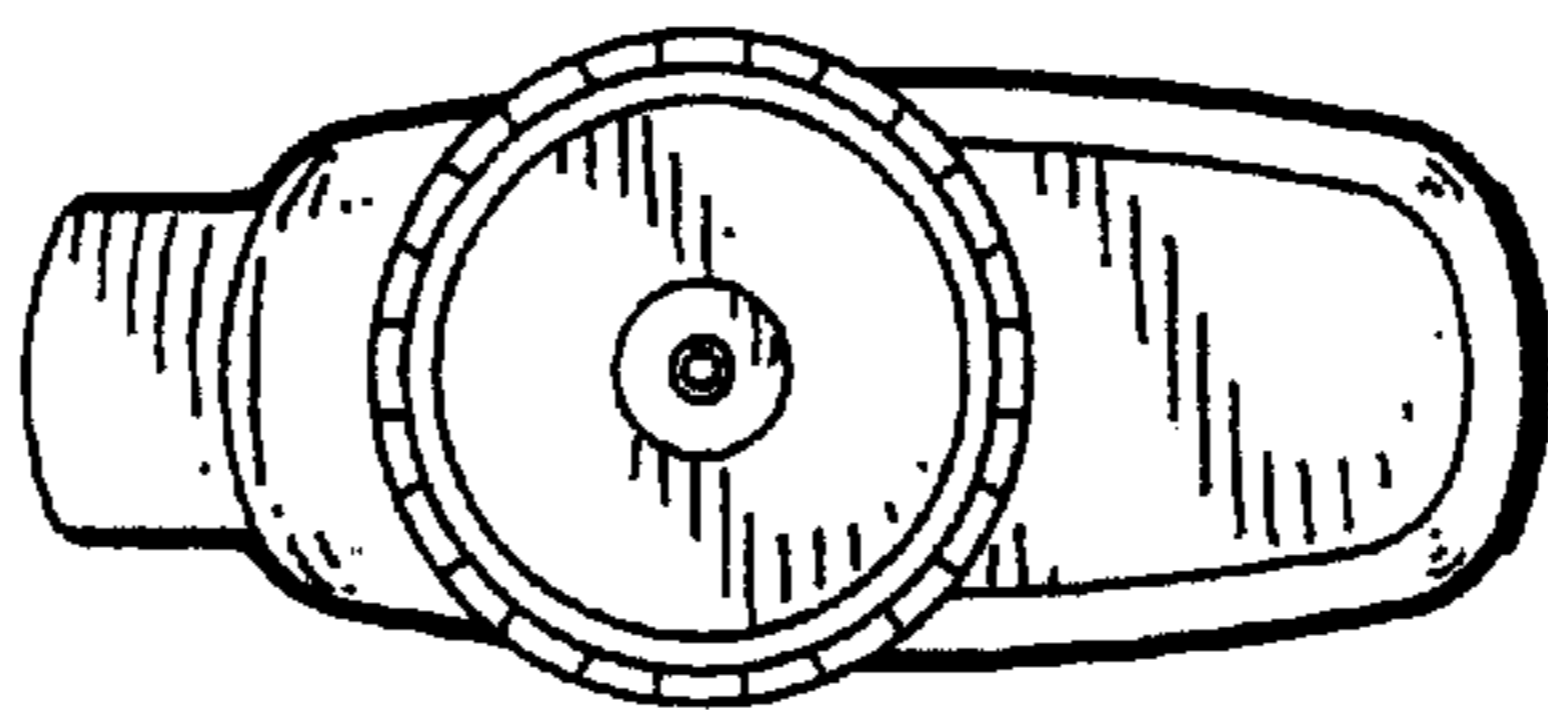

FIG. 7

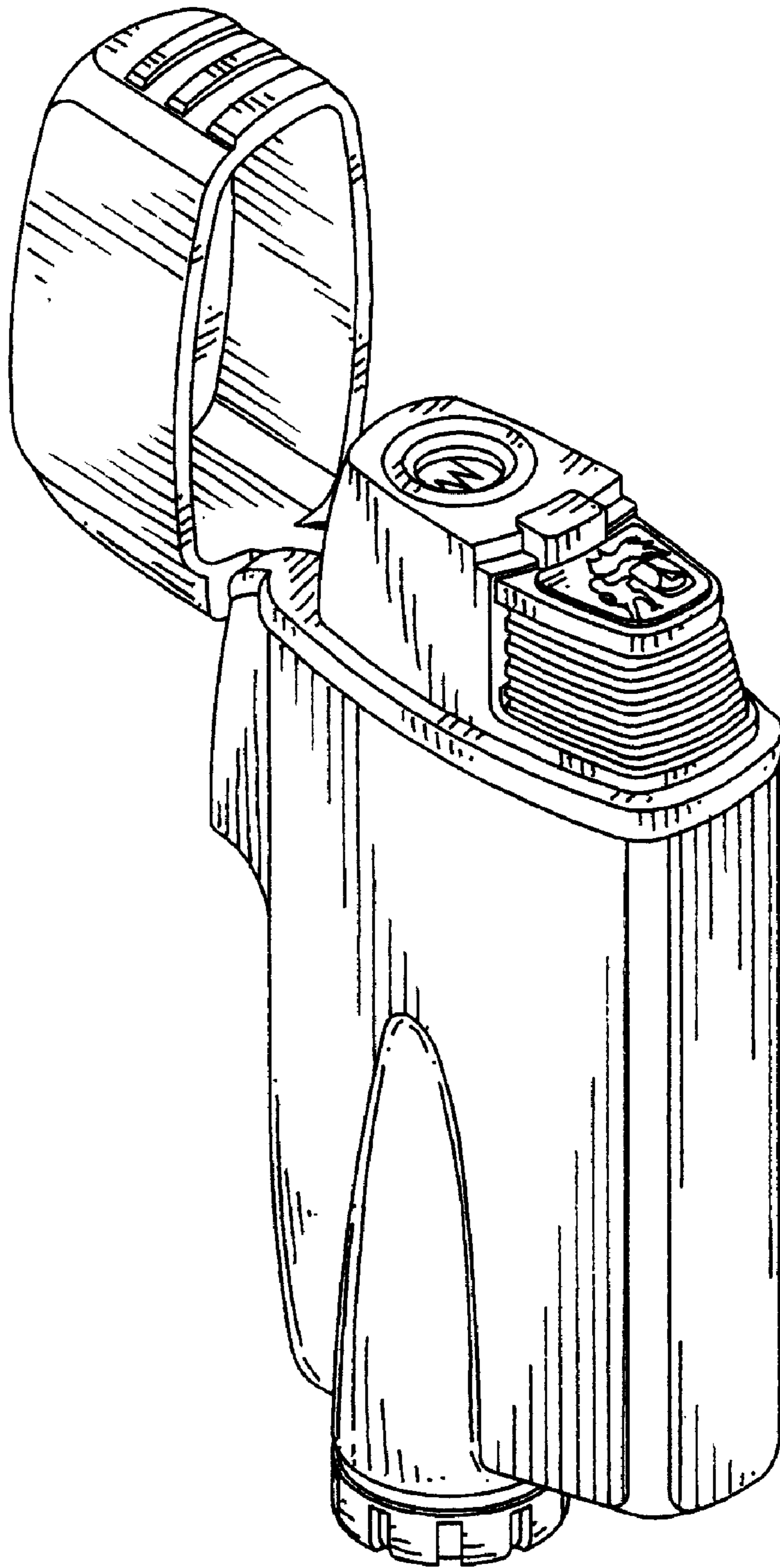

FIG. 8