



US00D435141S

United States Patent [19] Reynolds

[11] **Patent Number: Des. 435,141**

[45] **Date of Patent: ** Dec. 12, 2000**

[54] **MULTI-FUNCTION CIGARETTE LIGHTER**

[75] Inventor: **Michael P. Reynolds**, Warwick, R.I.

[73] Assignee: **Colibri Corporation**

[**] Term: **14 Years**

[21] Appl. No.: **29/125,457**

[22] Filed: **Jun. 23, 2000**

[51] **LOC (7) Cl. 26-99**

[52] **U.S. Cl. D27/142; D8/34; D8/105;
D10/62; D10/68**

[58] **Field of Search 431/253; D27/141,
D27/142, 143, 154, 155, 157, 159; D8/34,
105; D10/68, 62**

[56] **References Cited**

U.S. PATENT DOCUMENTS

D. 196,934	11/1963	Graham	D27/142
D. 376,668	12/1996	Maruyama	D27/141
5,169,303	12/1992	Kee	431/253
5,653,525	8/1997	Park	431/253 X
5,829,965	11/1998	Rubalcava	431/253

Primary Examiner—Susan J. Lucas
Assistant Examiner—Jennifer Rivard
Attorney, Agent, or Firm—Salter & Michaelson

[57] **CLAIM**

The ornamental design for a multi-function cigarette lighter, as shown and described.

DESCRIPTION

FIG. 1 is a perspective view of a multi-function cigarette lighter showing my new design;
FIG. 2 is a rear elevational view thereof;
FIG. 3 is a front elevational view thereof;
FIG. 4 is a left side view thereof;
FIG. 5 is a right side view thereof;
FIG. 6 is a top plan view thereof;
FIG. 7 is a bottom plan view thereof; and,
FIG. 8 is a front elevational view thereof showing the knife blade and bottle opener in partially open position and the cigarette lighter cap in open position.

The rear view of the knife blade and the bottle opener is a mirror image of the front view that is shown in the FIG. 8.

1 Claim, 6 Drawing Sheets

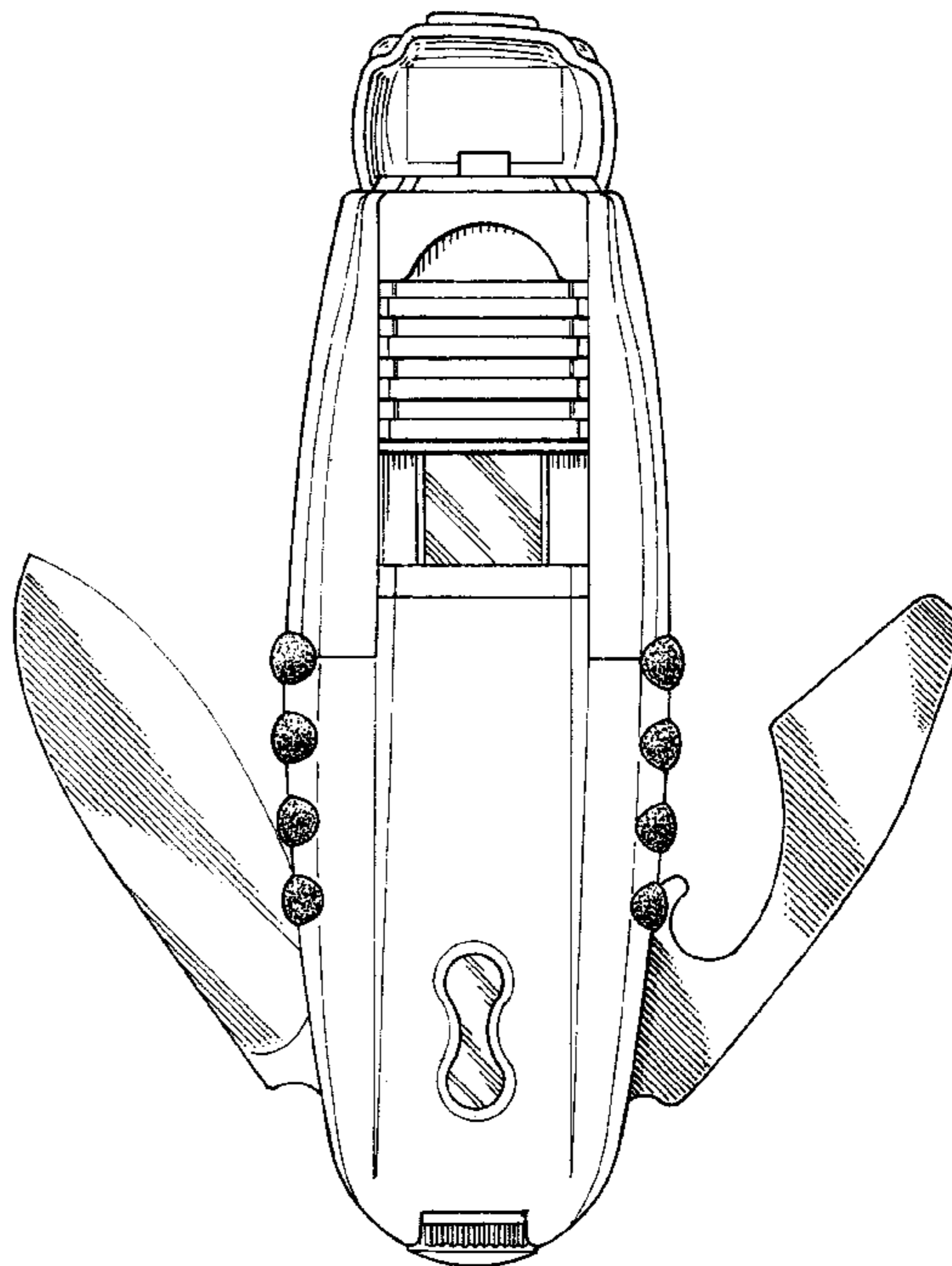
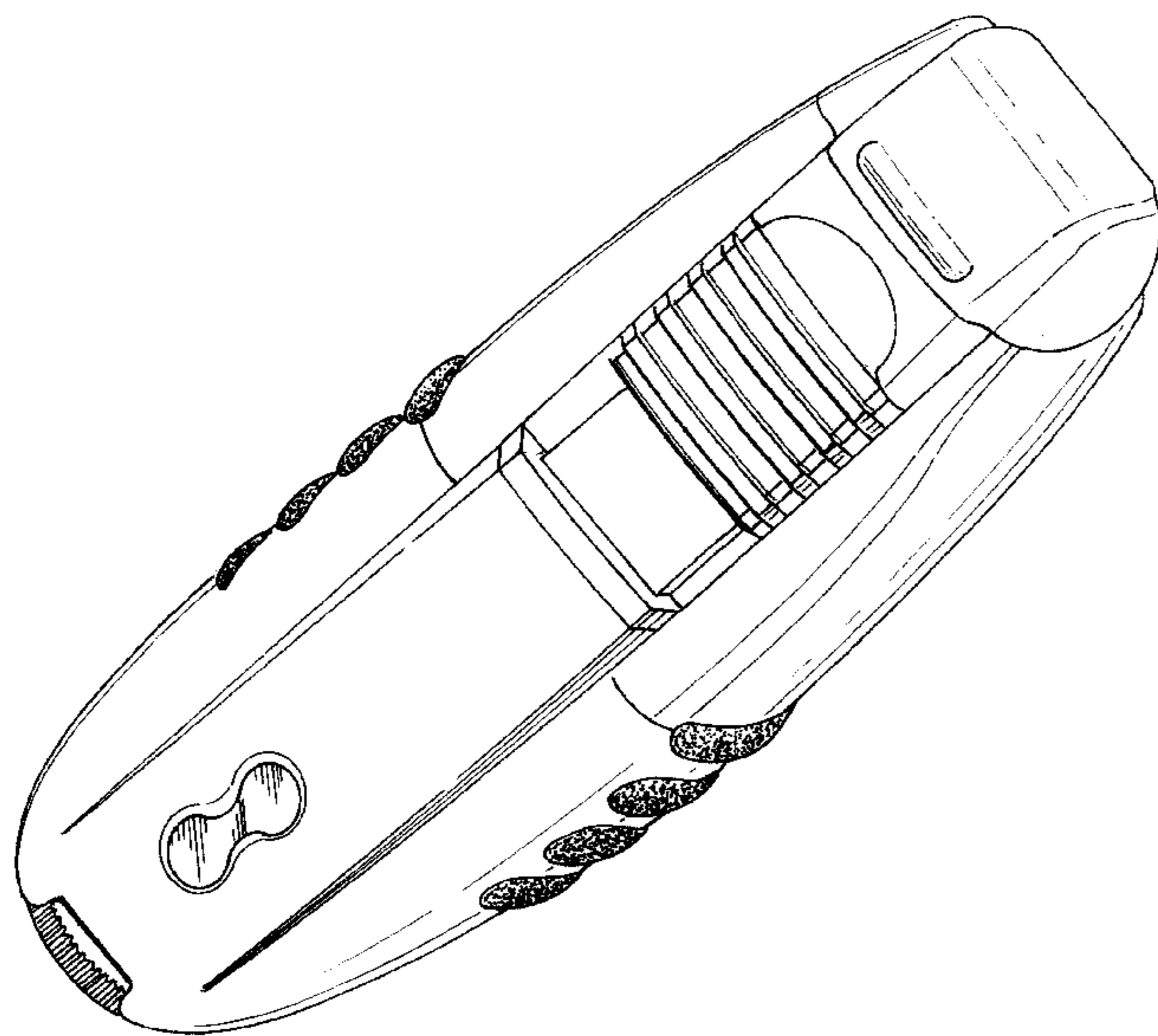

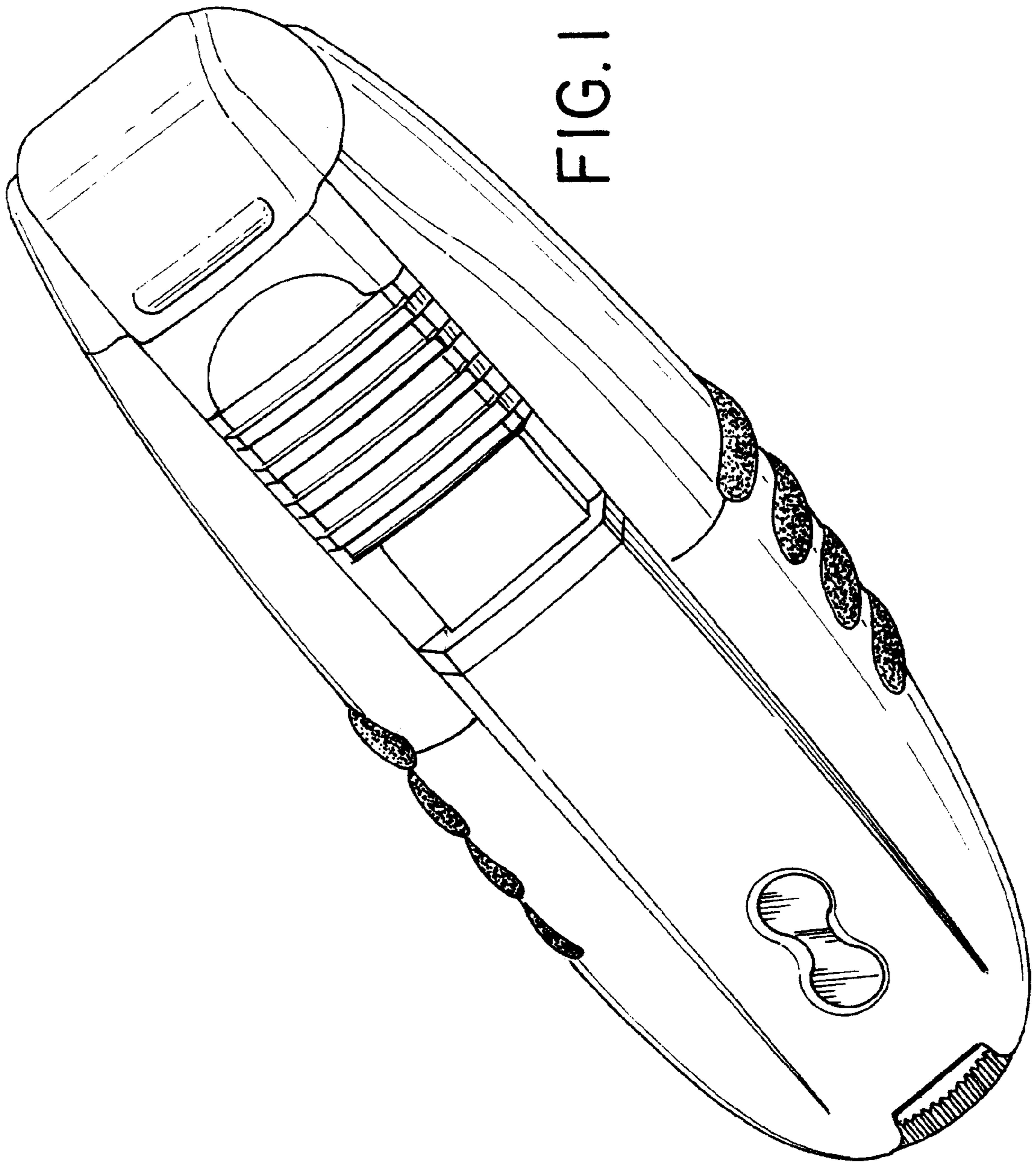

FIG. 1

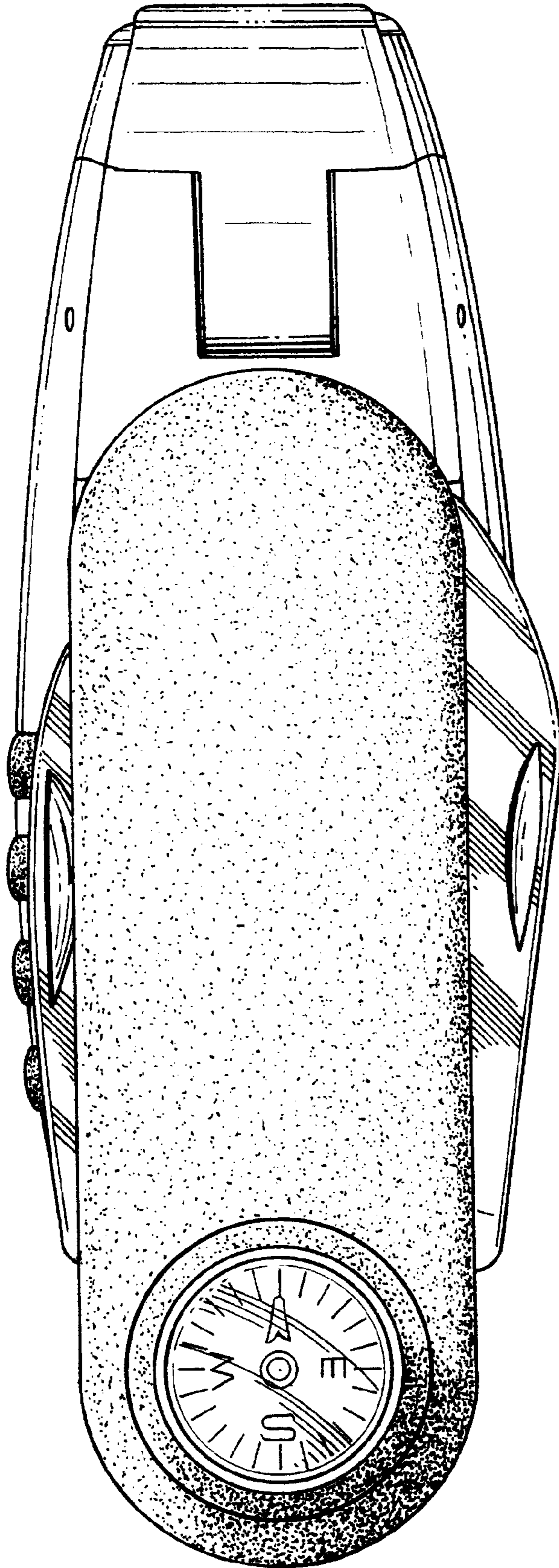

FIG.2

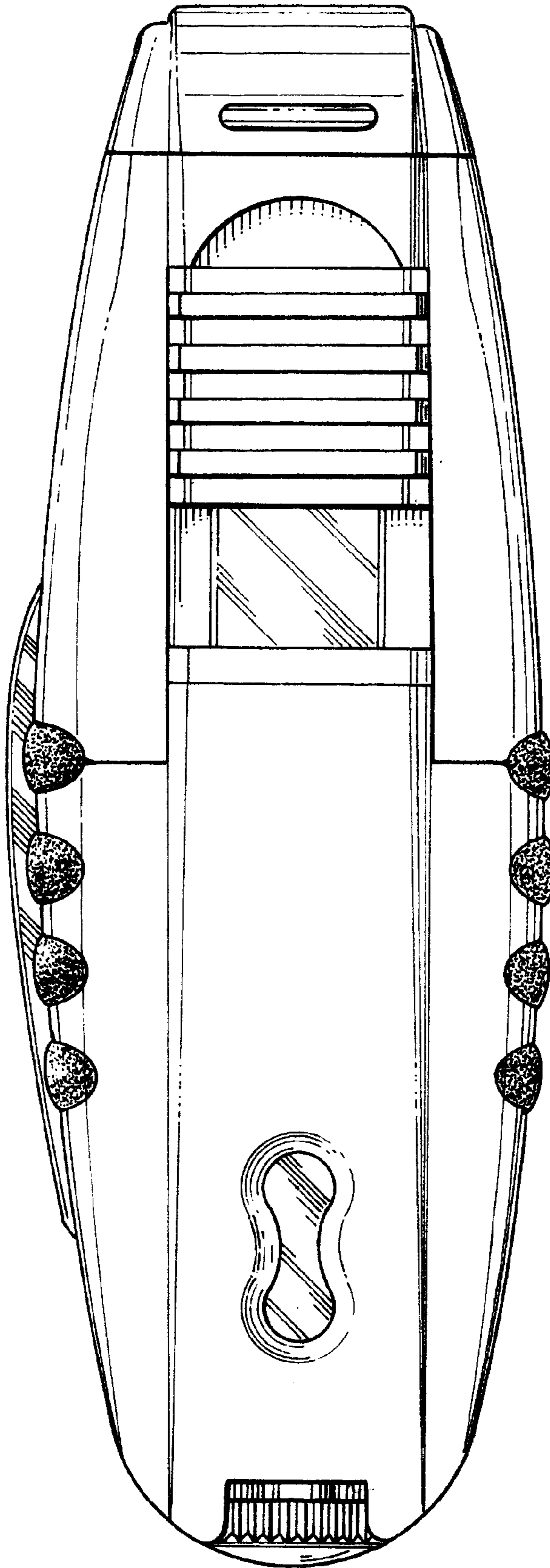

FIG. 3

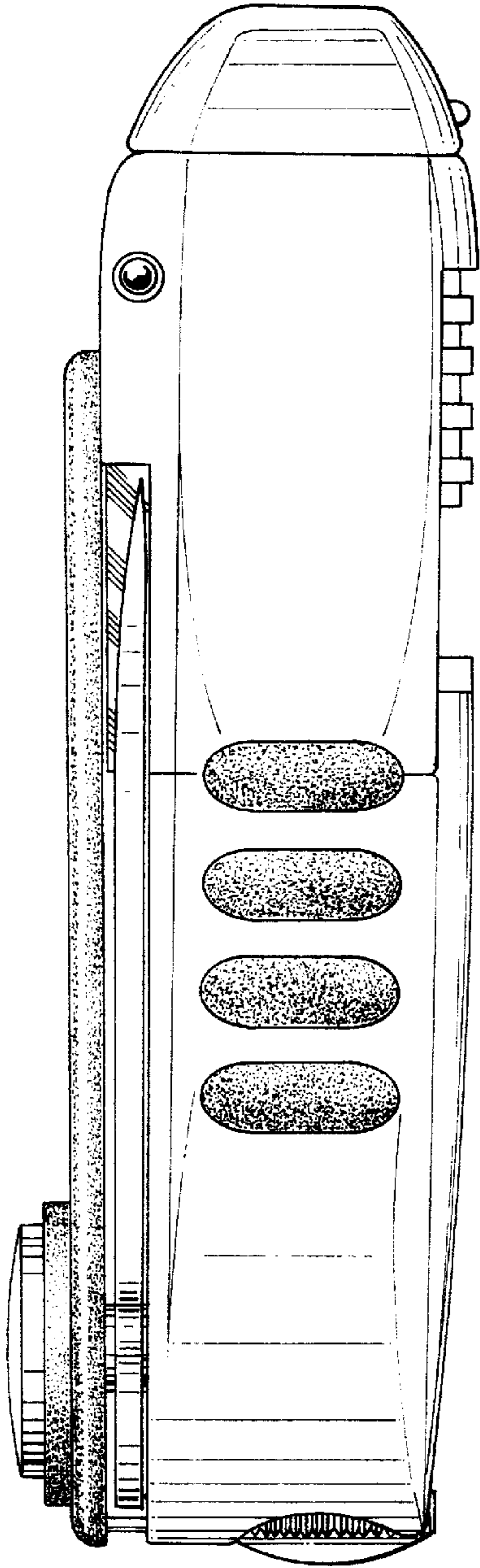
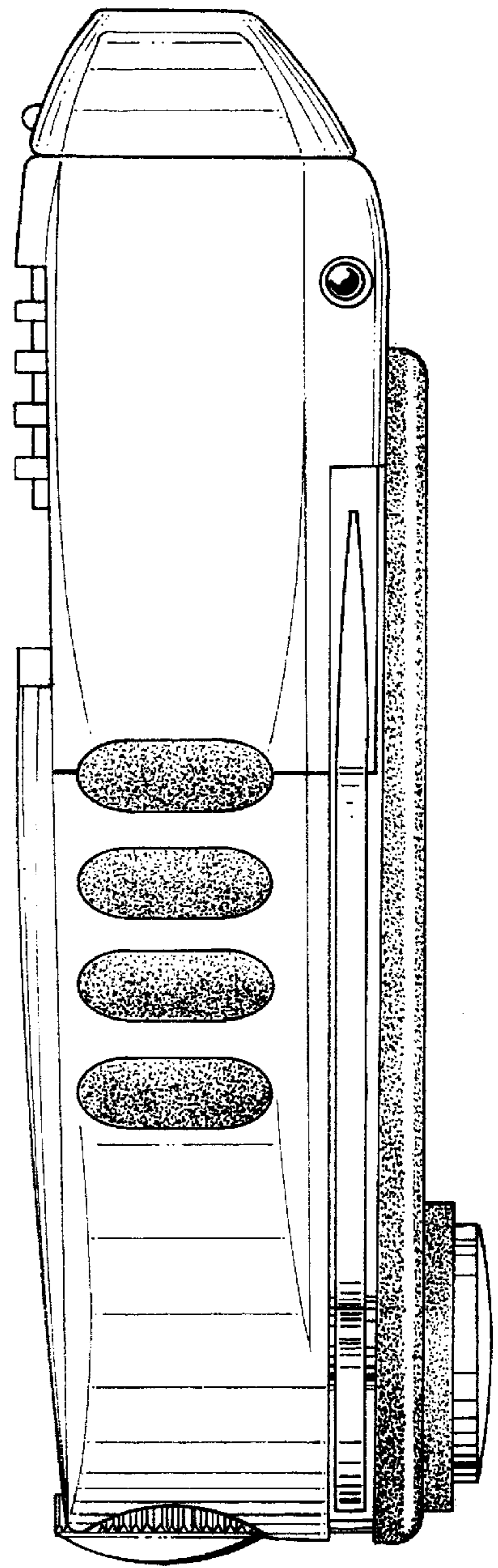

FIG. 4

FIG. 5



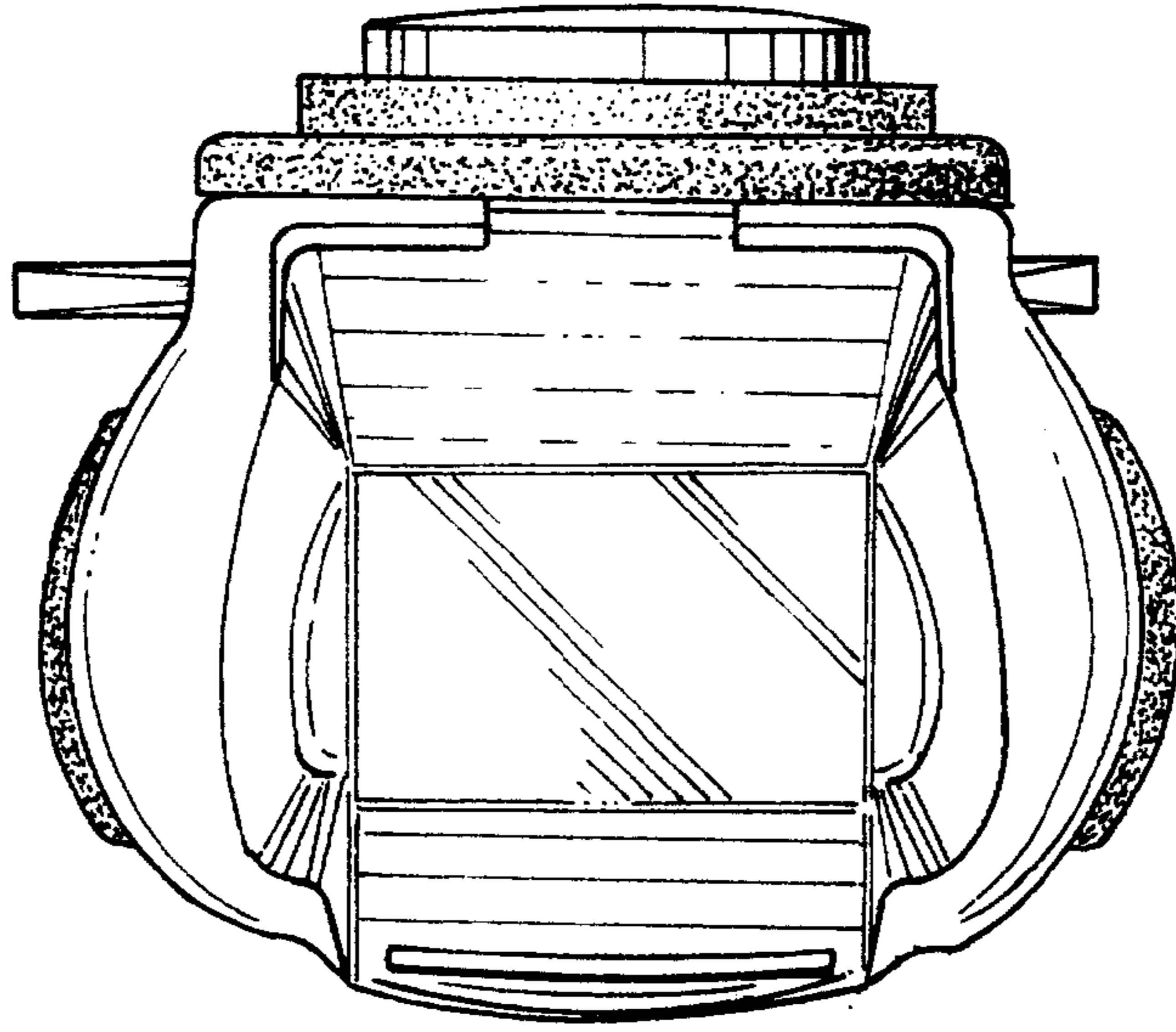
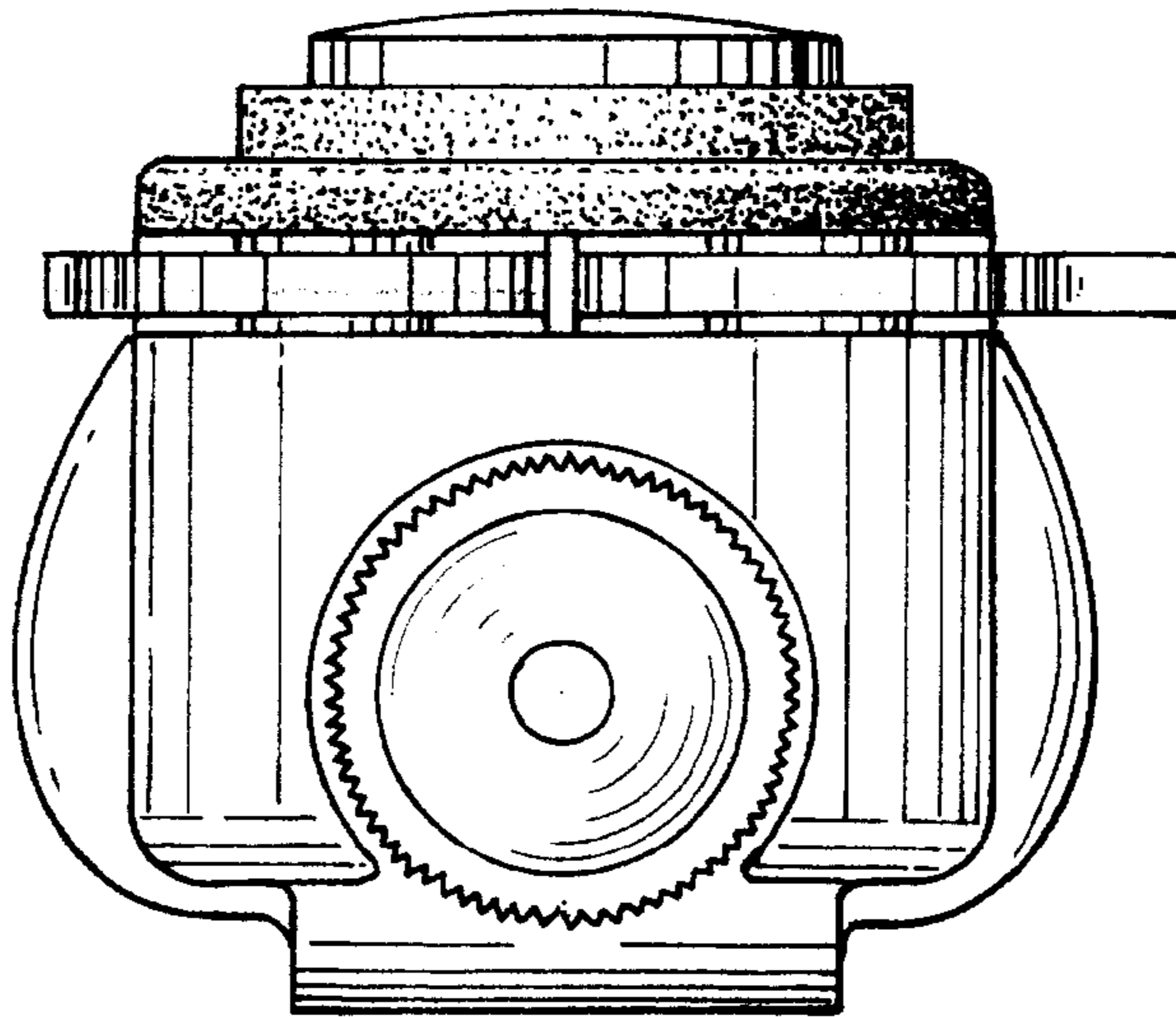

FIG. 6

FIG. 7



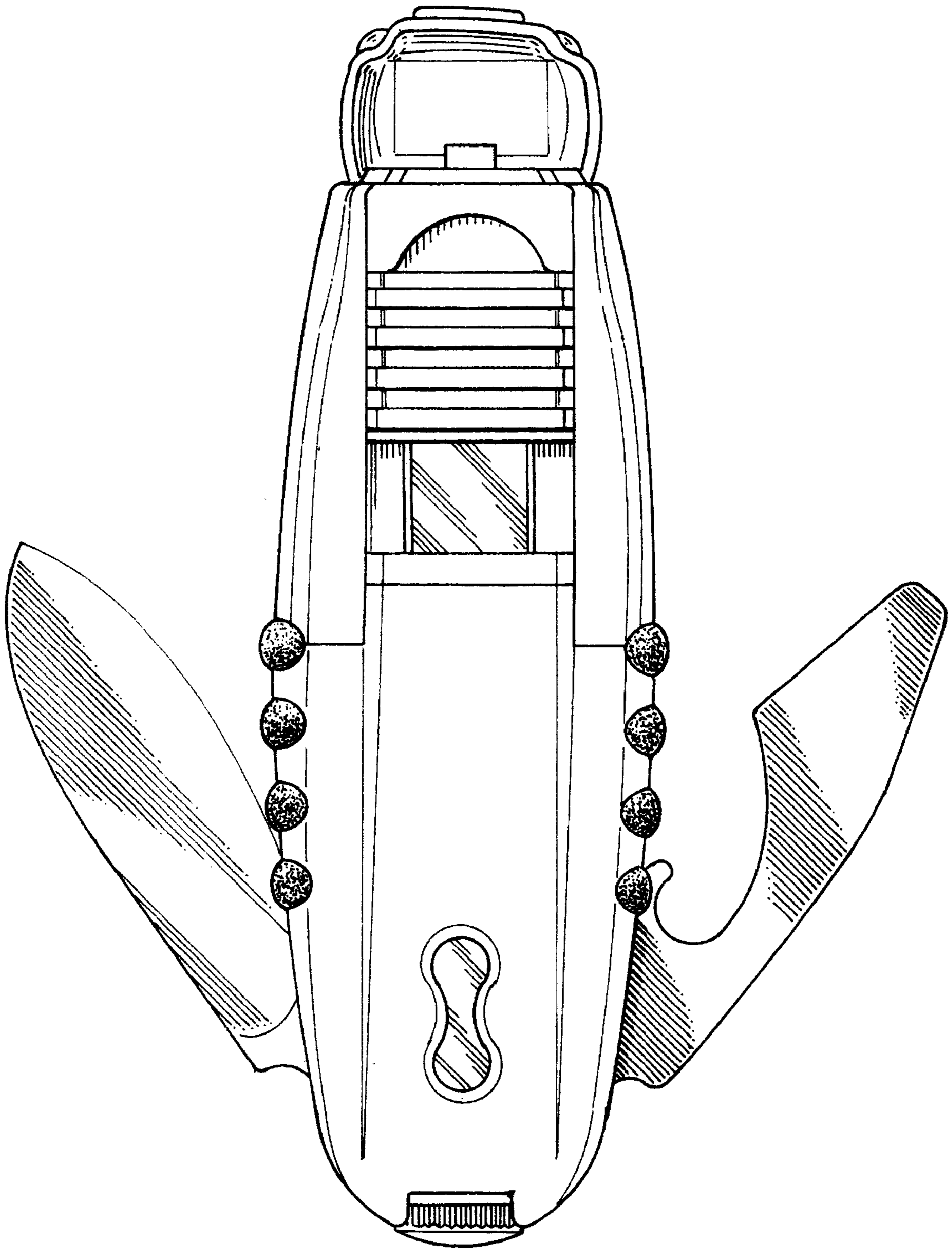

FIG. 8