



US00D435123S

United States Patent [19]

[11] **Patent Number: Des. 435,123**

Lu

[45] **Date of Patent: ** Dec. 12, 2000**

[54] **TORCH**

5,807,093 9/1998 Tendick 431/320
5,938,430 8/1999 Majerowski 431/320

[75] Inventor: **James Lu**, Roswell, Ga.

Primary Examiner—Robin V. Taylor
Attorney, Agent, or Firm—Rodgers & Rodgers

[73] Assignee: **International Business Corporation**,
Alpharetta, Ga.

[57] **CLAIM**

[**] Term: **14 Years**

The ornamental design for a torch, as shown.

[21] Appl. No.: **29/118,737**

DESCRIPTION

[22] Filed: **Feb. 15, 2000**

FIG. 1 is a perspective view of a torch showing my new design;

[51] **LOC (7) Cl.** **26-02**

FIG. 2 is a top plan view thereof;

[52] **U.S. Cl.** **D26/8**

FIG. 3 is a bottom plan view thereof;

[58] **Field of Search** D26/8, 9; 431/320,
431/350, 343, 345

FIG. 4 is a front elevational view thereof;

FIG. 5 is a right side elevational view thereof;

FIG. 6 is a rear elevational view thereof; and,

FIG. 7 is a left side elevational view thereof.

[56] **References Cited**

U.S. PATENT DOCUMENTS

5,320,521 6/1994 Bussu 431/320

1 Claim, 3 Drawing Sheets

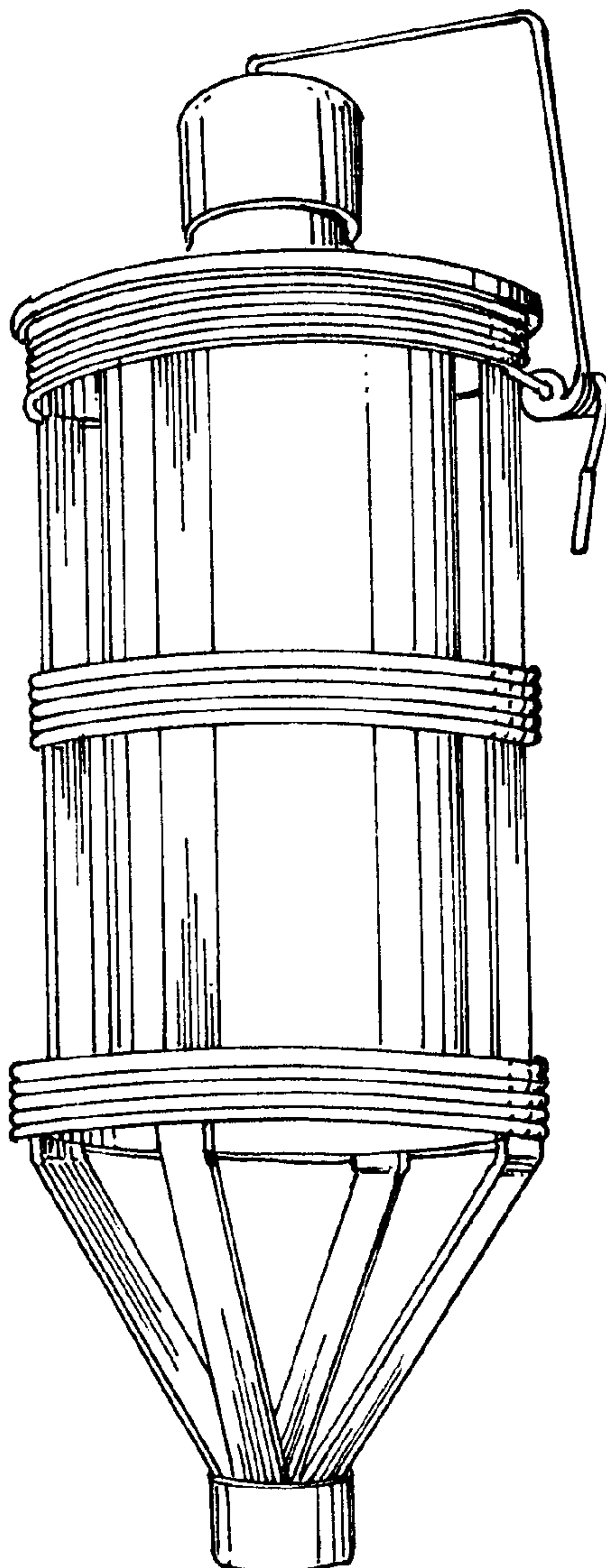

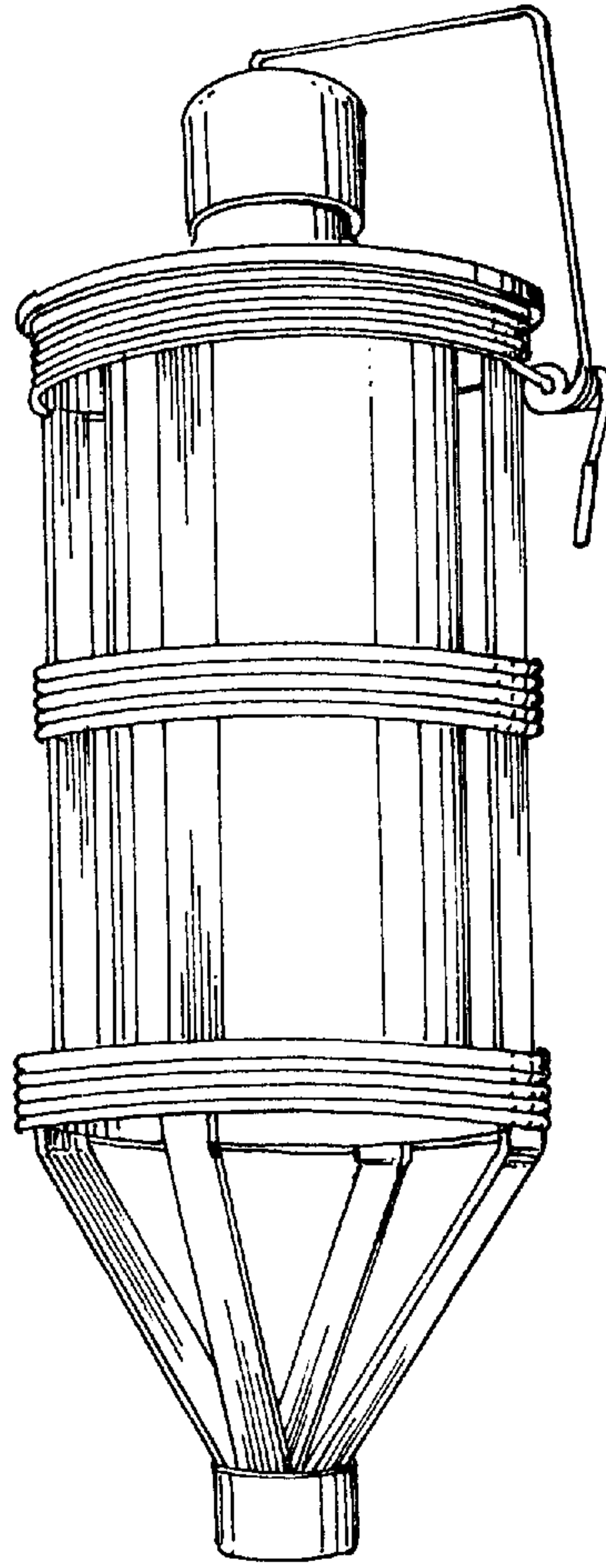

FIG. 1

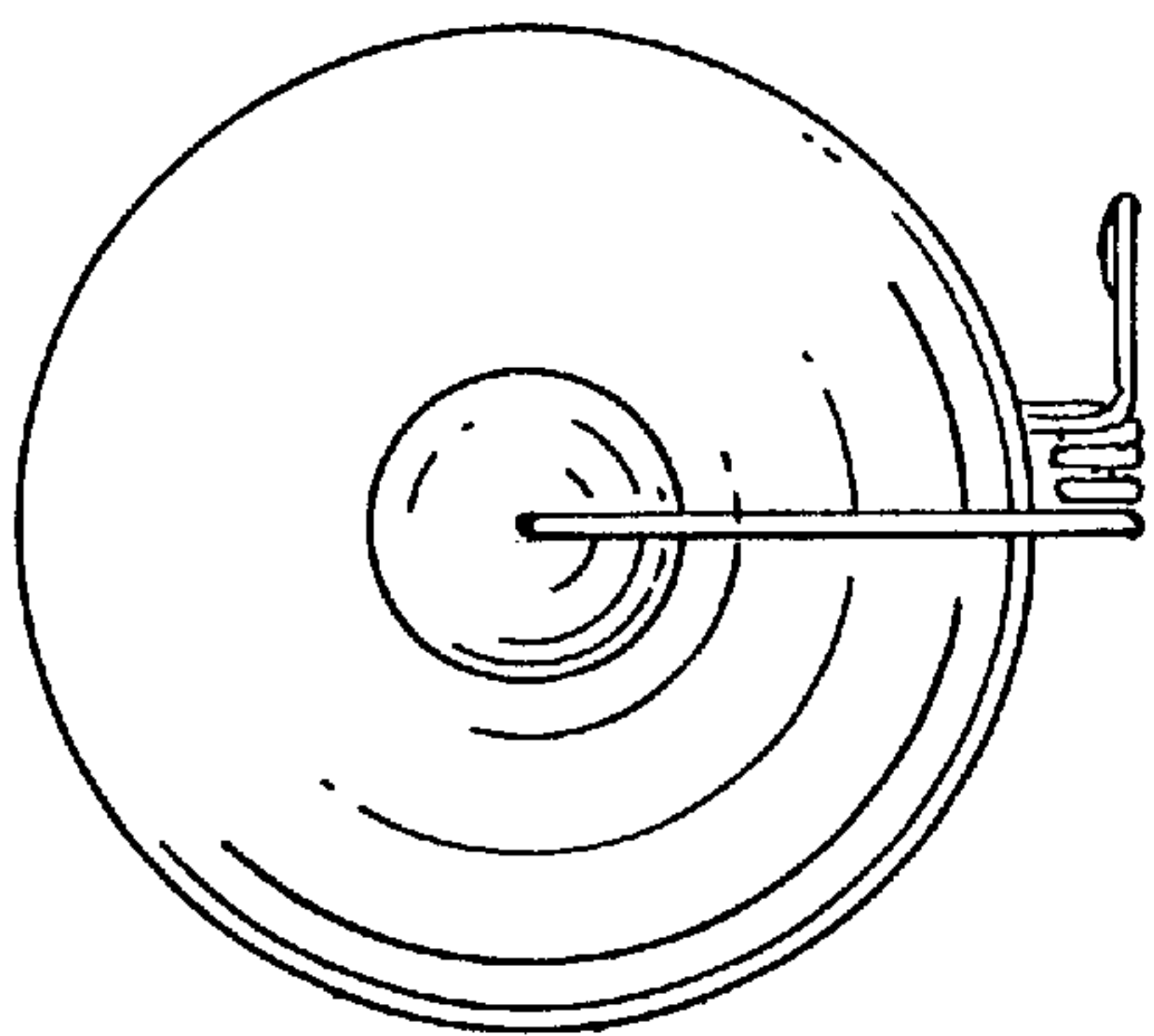

FIG. 2

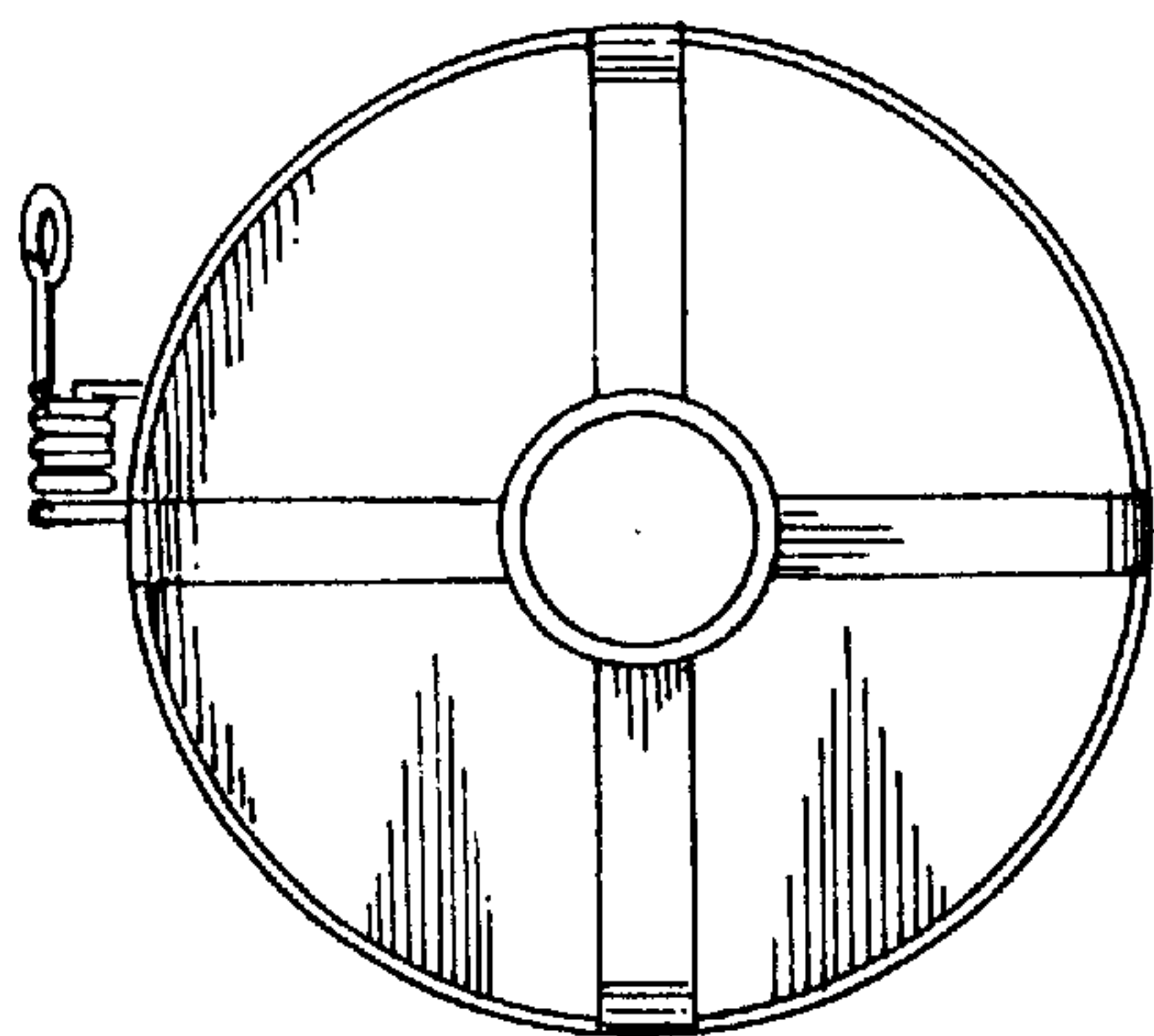

FIG. 3

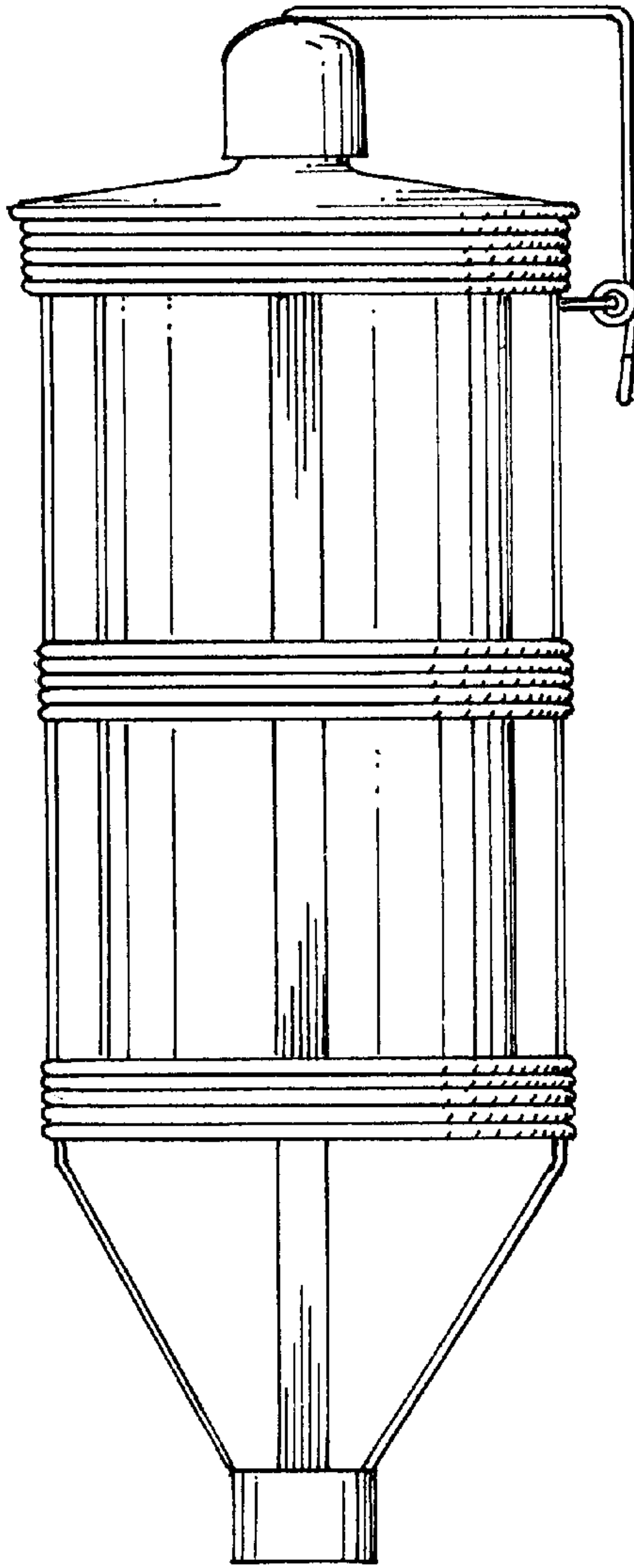

FIG. 4

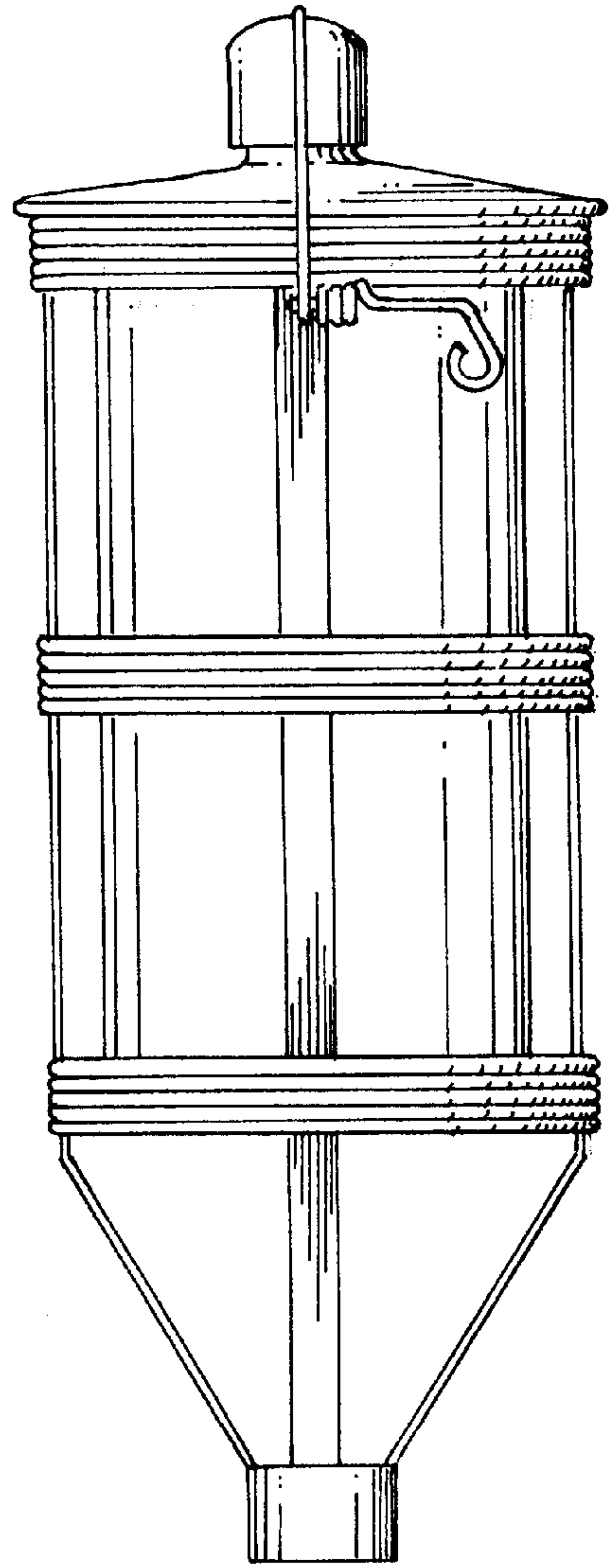

FIG. 5

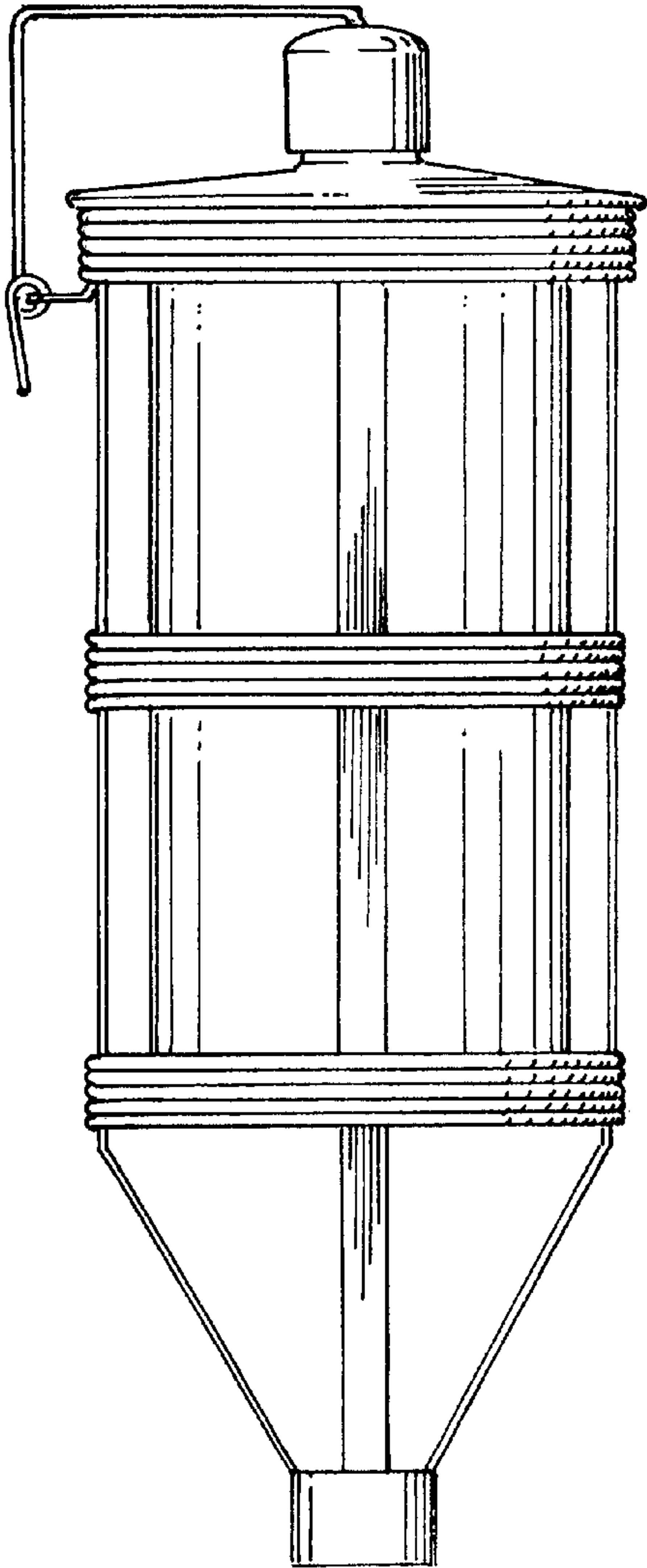

FIG. 6

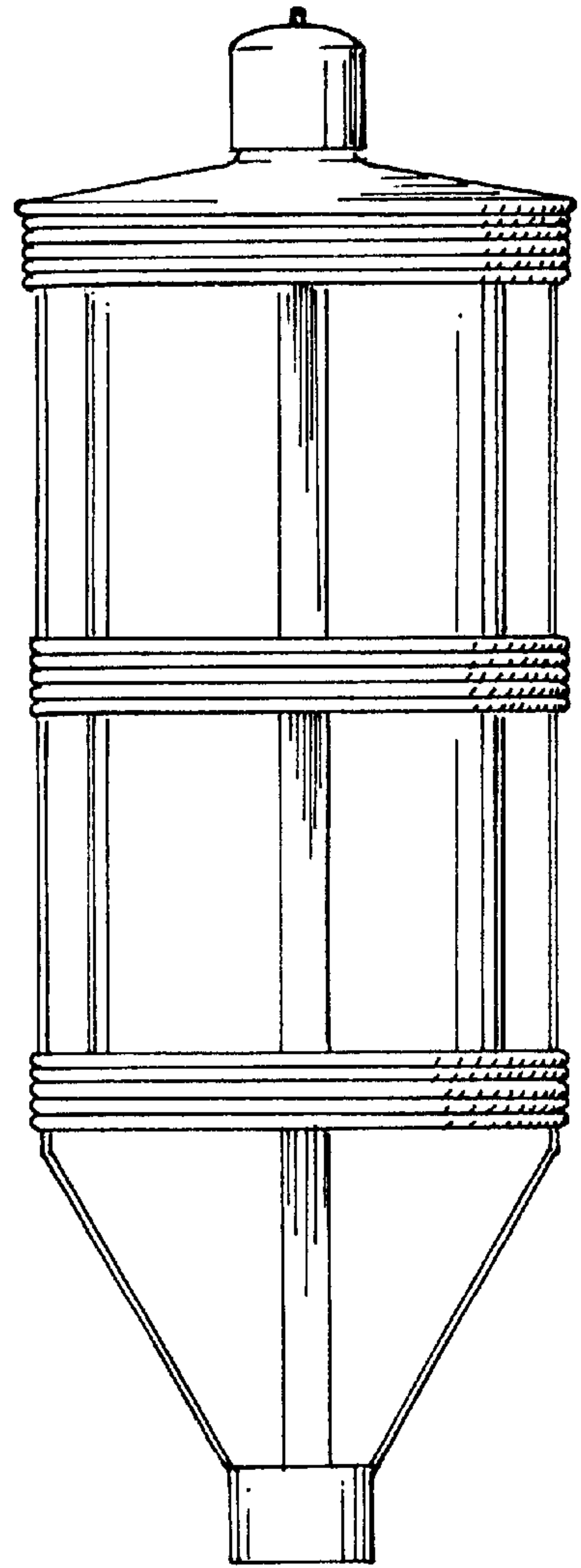

FIG. 7