



US00D435118S

United States Patent [19] Takahashi

[11] **Patent Number: Des. 435,118**

[45] **Date of Patent: ** Dec. 12, 2000**

[54] **STEP FOR CLIMBING WALL SURFACE**

[75] Inventor: **Eizo Takahashi**, Soka, Japan

[73] Assignee: **Miyama Kogyo Co., Ltd.**, Soka, Japan

[**] Term: **14 Years**

[21] Appl. No.: **29/106,669**

[22] Filed: **Jun. 22, 1999**

[30] **Foreign Application Priority Data**

Dec. 22, 1998 [JP] Japan 10-36993

[51] **LOC (7) Cl.** **25-04**

[52] **U.S. Cl.** **D25/69**

[58] **Field of Search** 182/90, 92; D25/69

[56] **References Cited**

U.S. PATENT DOCUMENTS

D. 304,376 10/1989 Robertson D25/69
4,869,342 9/1989 Borst 182/90

Primary Examiner—Doris Clark
Attorney, Agent, or Firm—Oblon, Spivak, McClelland,
Maier & Neustadt, P.C.

[57] **CLAIM**

The ornamental design for step for climbing wall surface, as shown and described.

DESCRIPTION

FIG. 1 is a top, front and right side perspective view of step for climbing wall surface embodying my new design; FIG. 2 is a bottom, front and left side perspective view thereof; FIG. 3 is a top plan view thereof; FIG. 4 is a bottom plan view thereof; FIG. 5 is a front elevational view thereof; FIG. 6 is a rear elevational view thereof; FIG. 7 is a right side view thereof; FIG. 8 is a left side view thereof; FIG. 9 is a top, front and right perspective view of step for climbing wall surface illustrating a second embodiment of my new design; FIG. 10 is a bottom, front and left side perspective view thereof; FIG. 11 is a top plan view thereof; FIG. 12 is a bottom plan view thereof; FIG. 13 is a front elevational thereof; FIG. 14 is a rear elevational thereof; FIG. 15 is a right side view thereof; and, FIG. 16 is a left side view thereof.

1 Claim, 9 Drawing Sheets

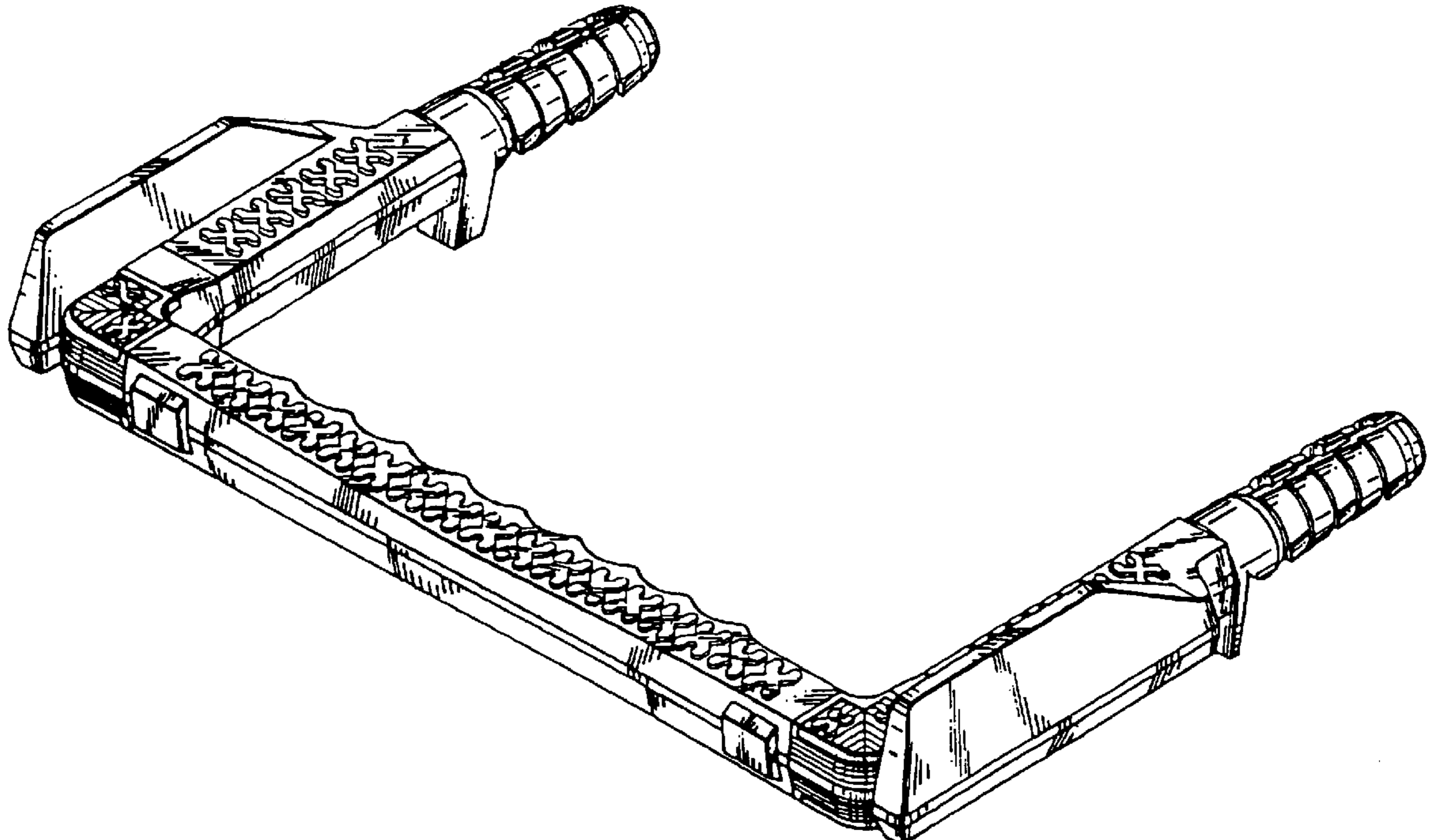

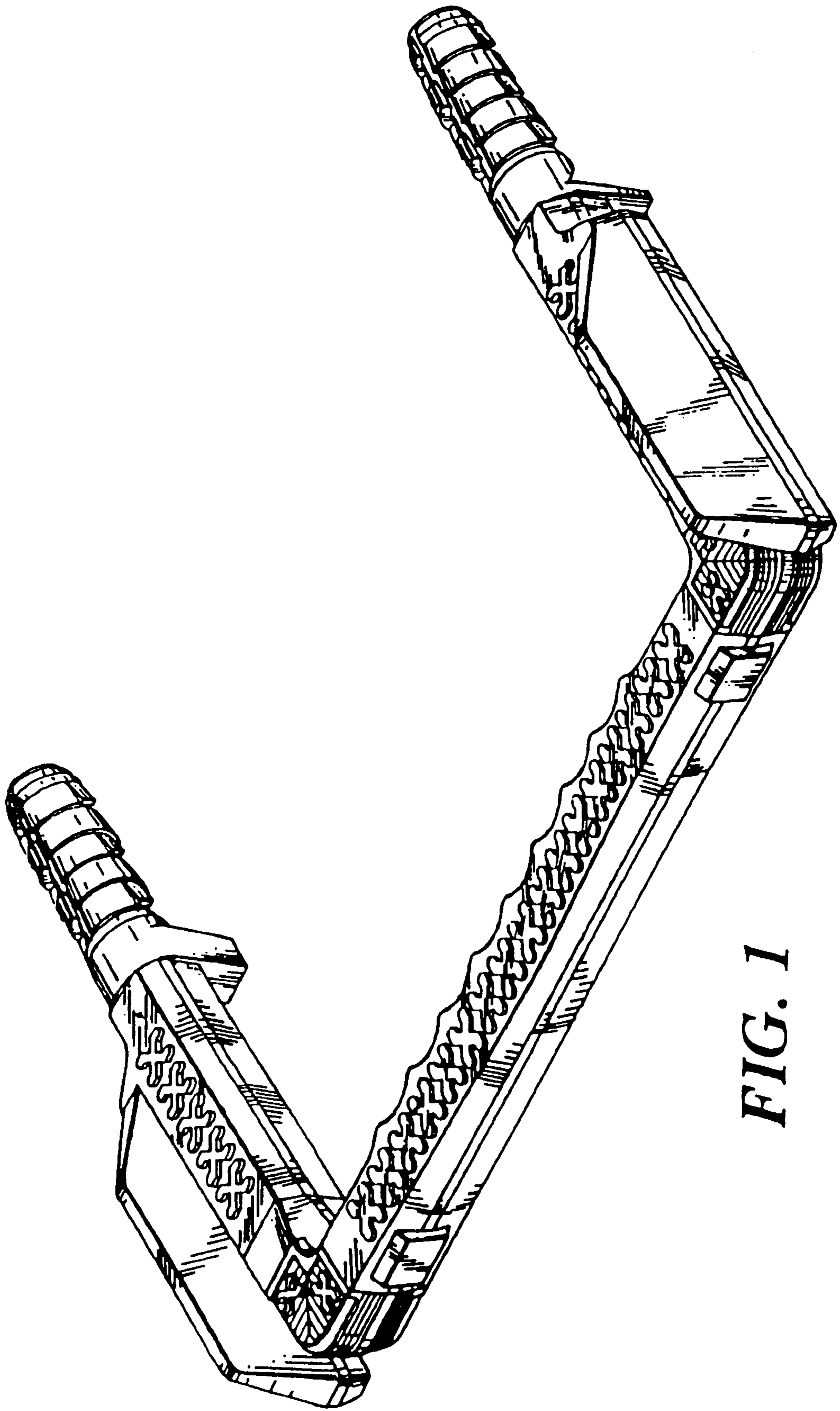

FIG. 1

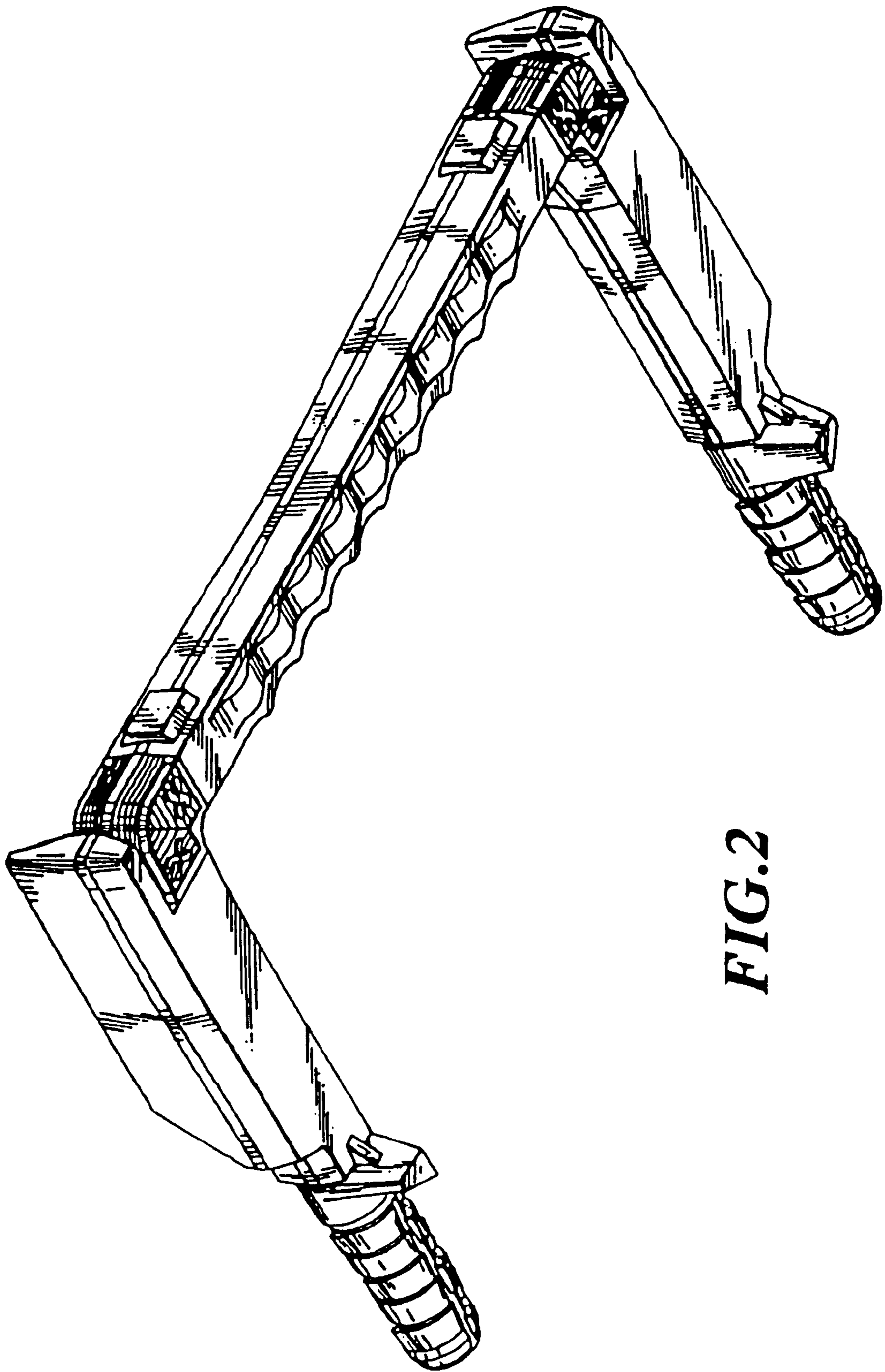

FIG. 2

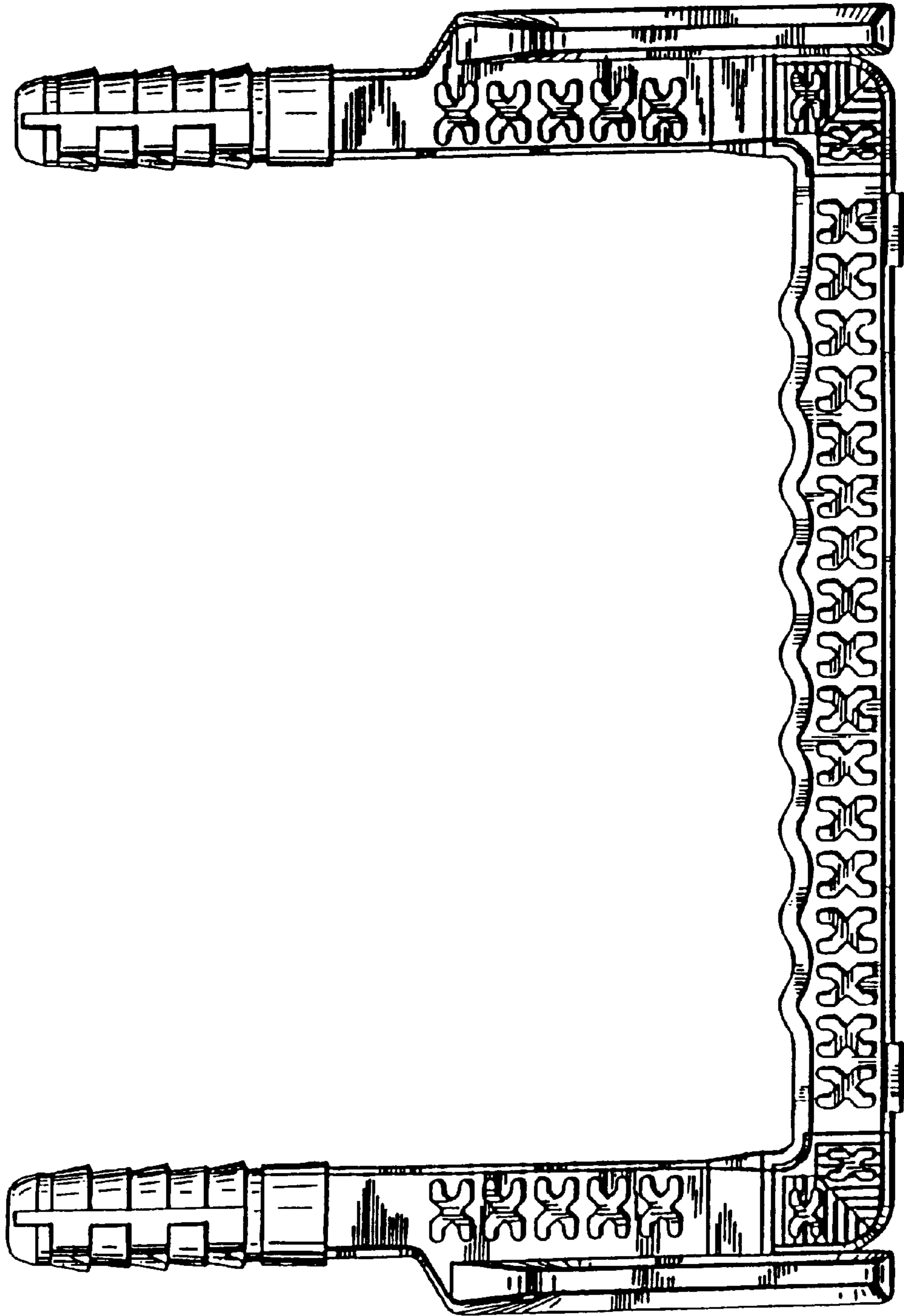

FIG. 3

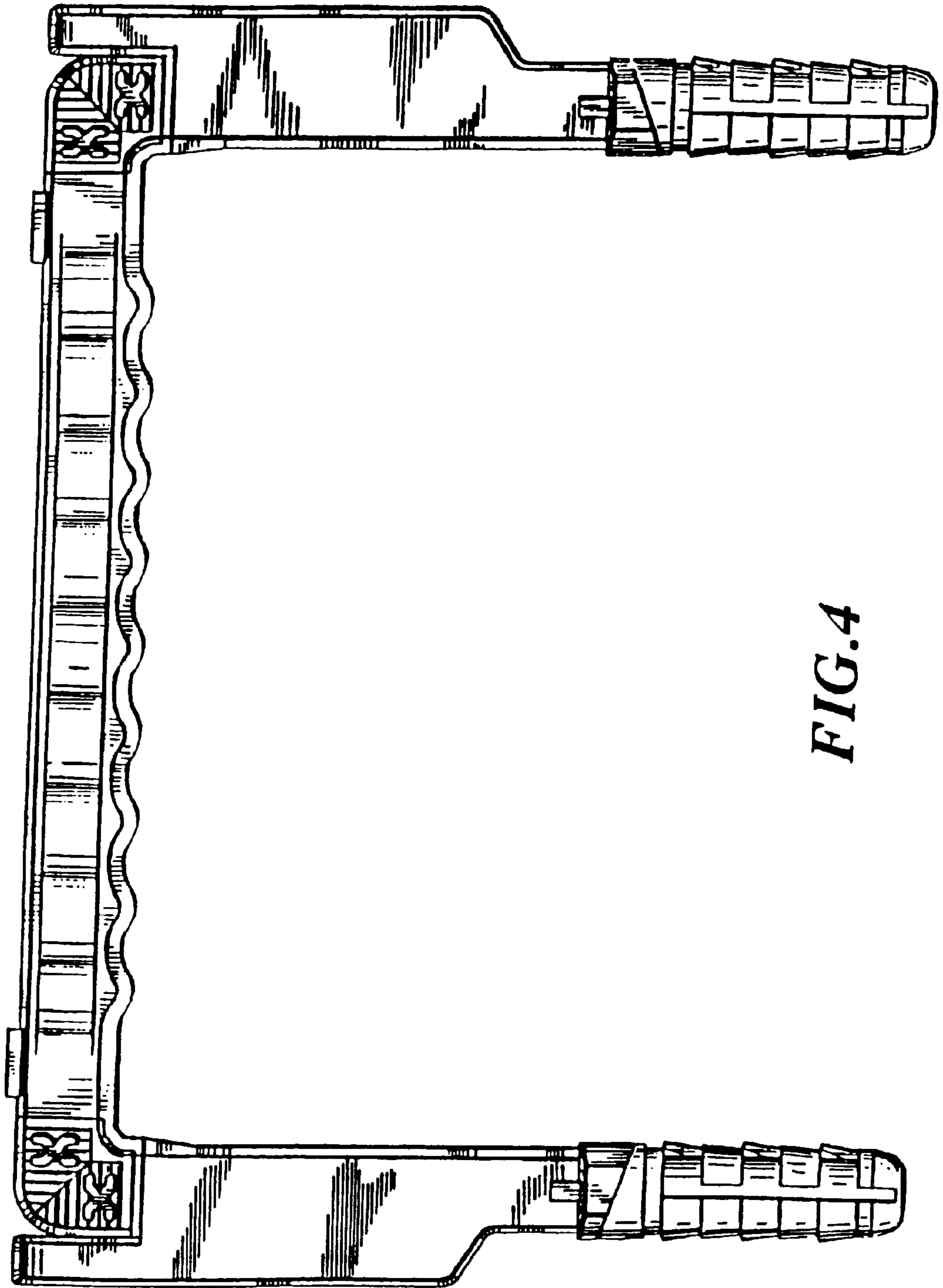

FIG. 4

FIG. 7

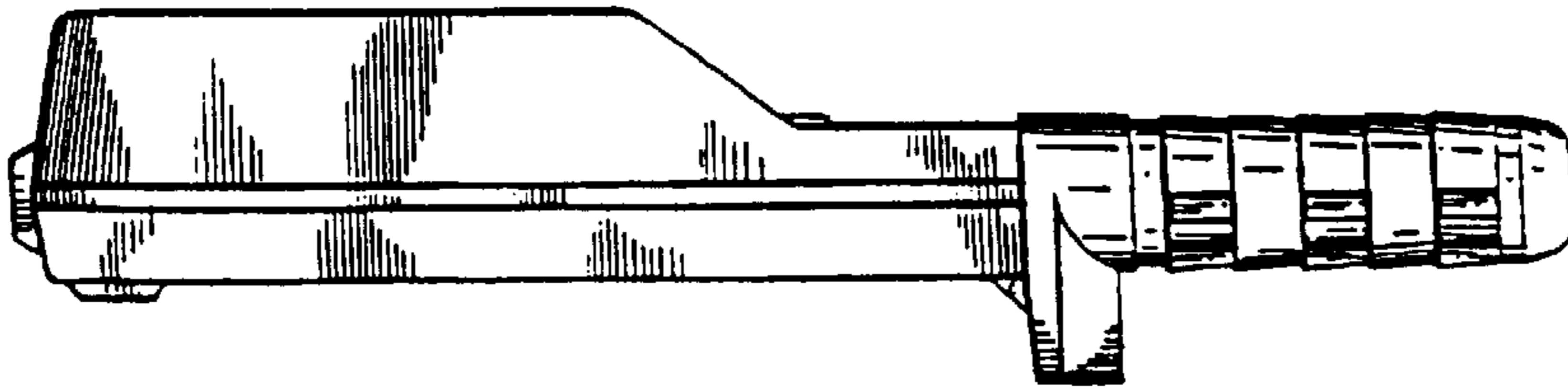

FIG. 8

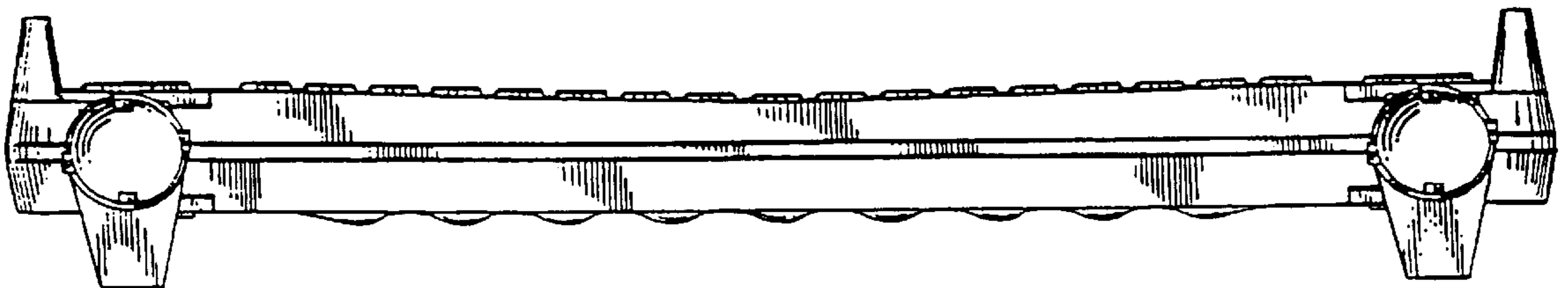
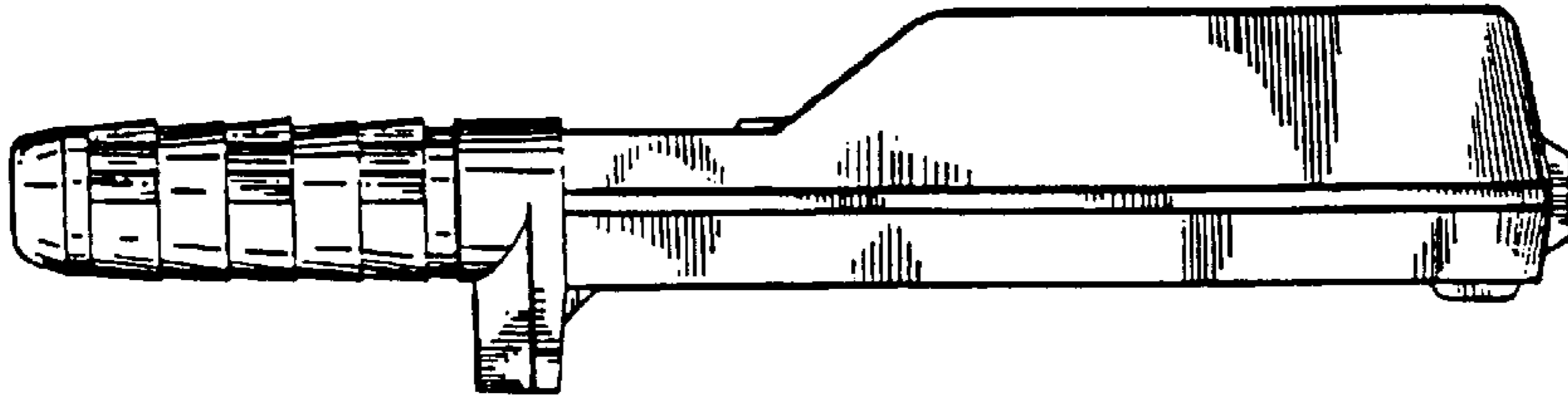

FIG. 6

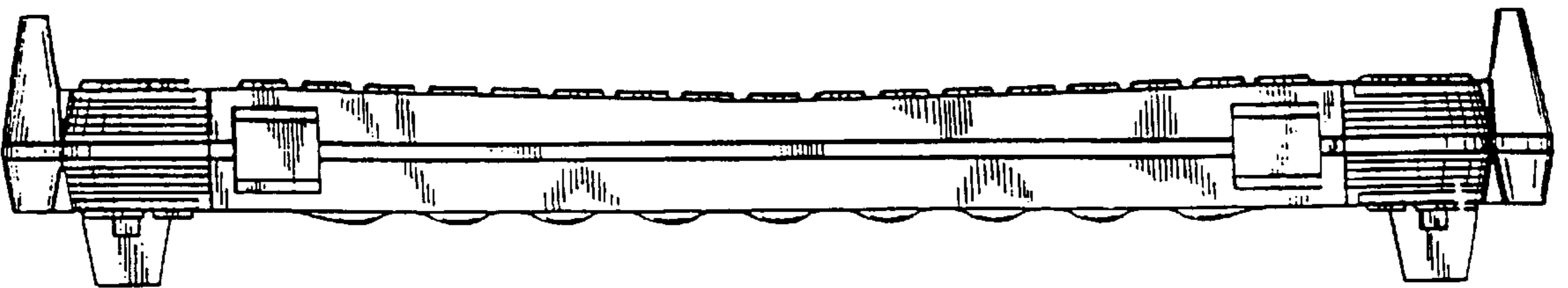
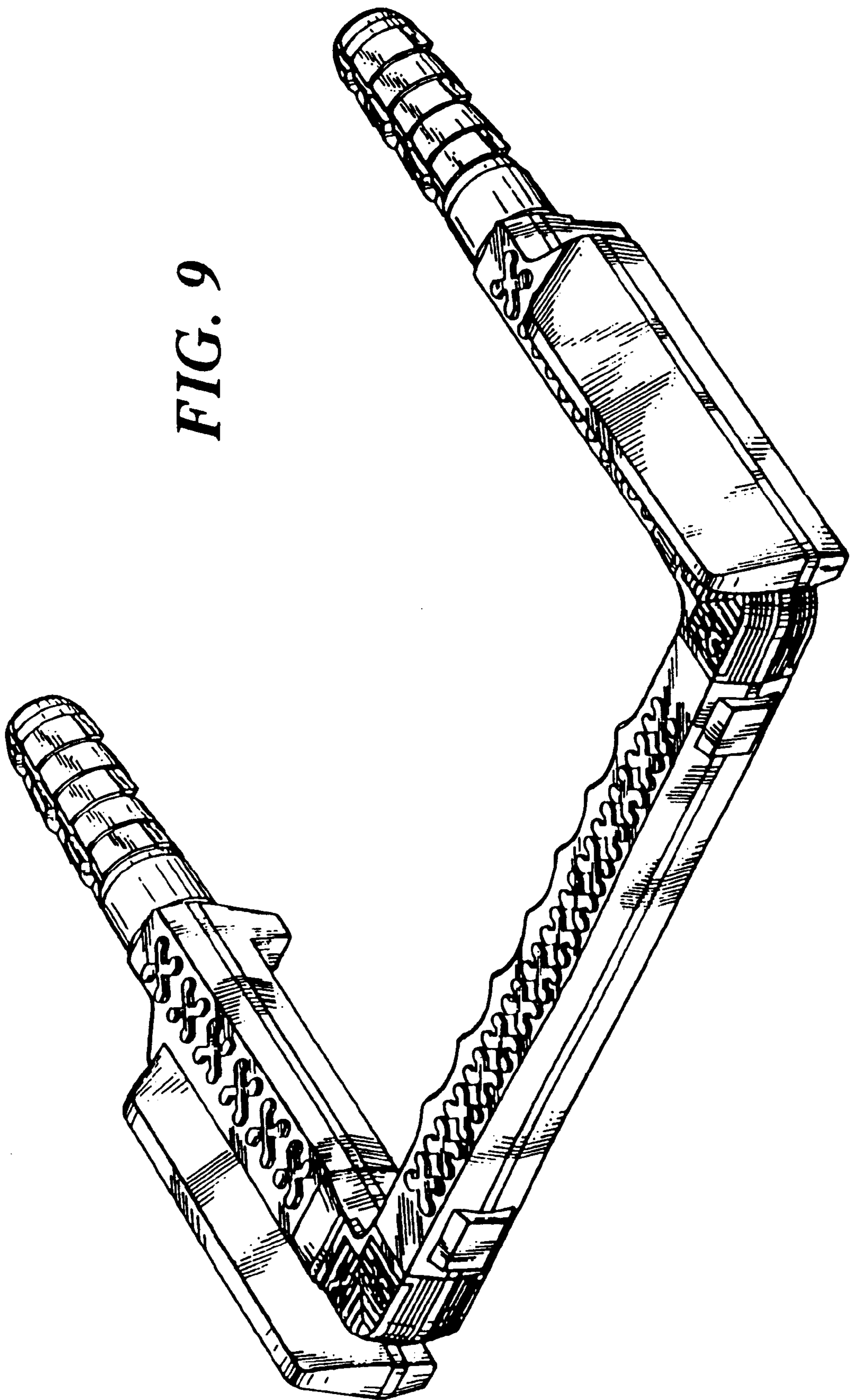

FIG. 5

FIG. 9



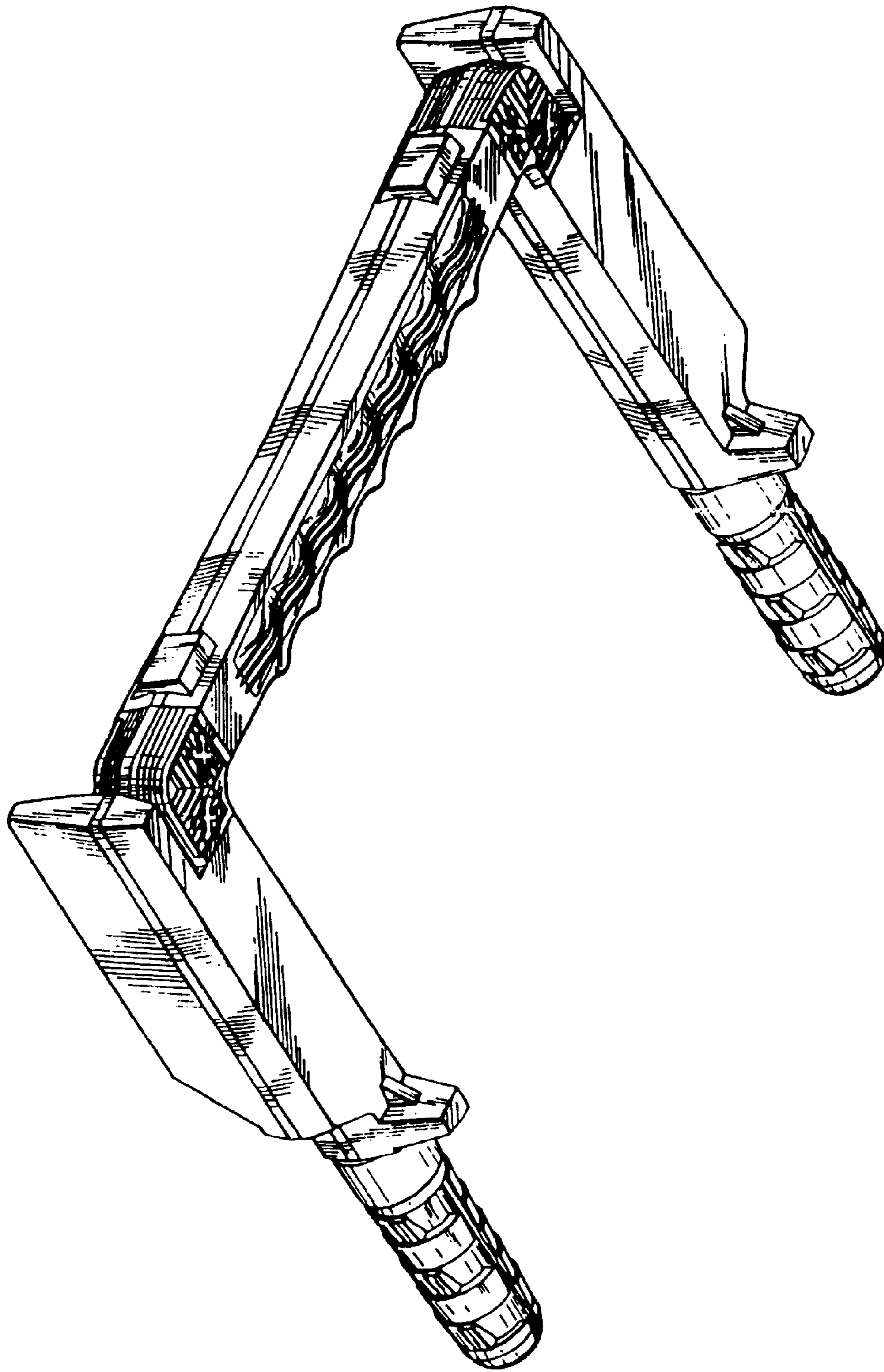

FIG. 10

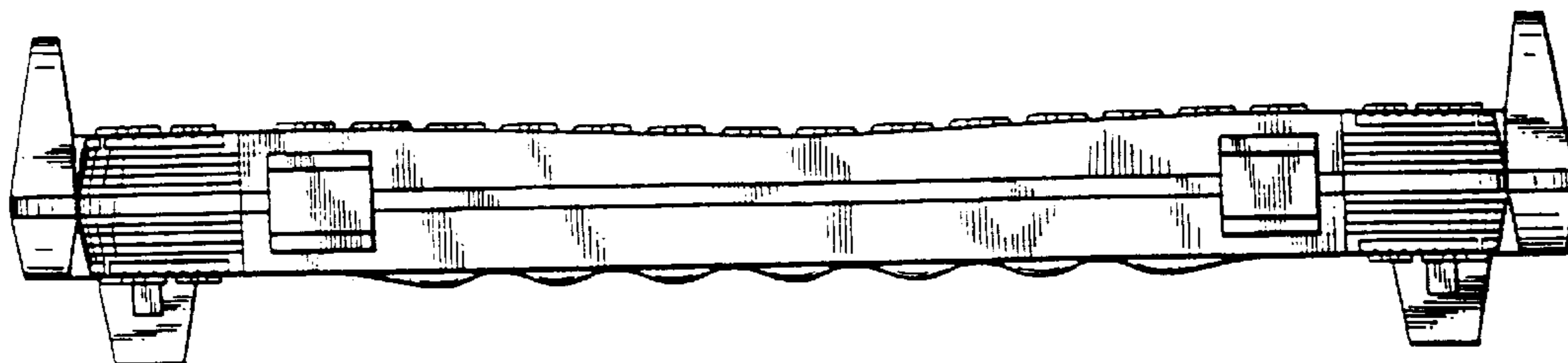

FIG. 13

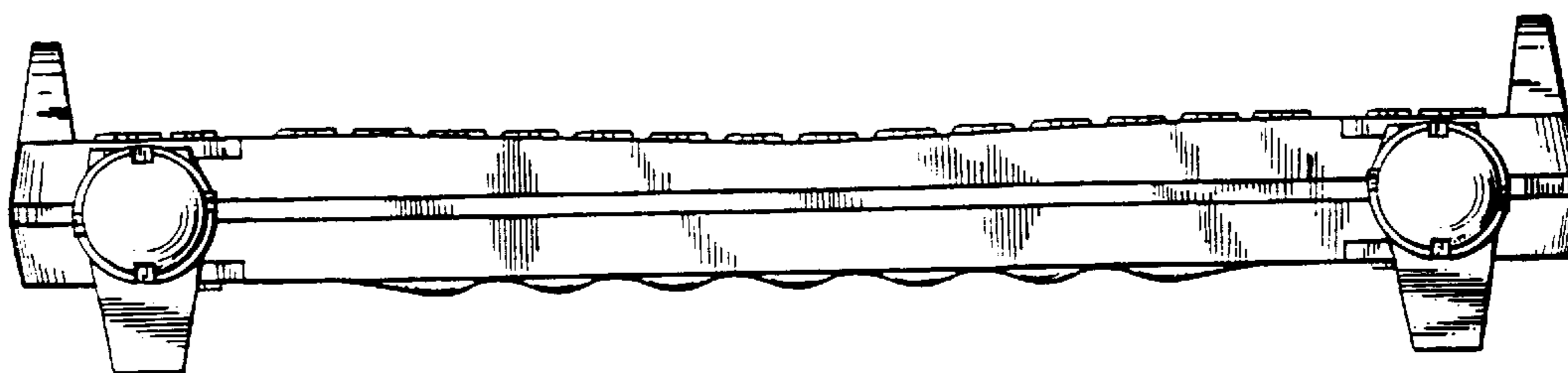

FIG. 14

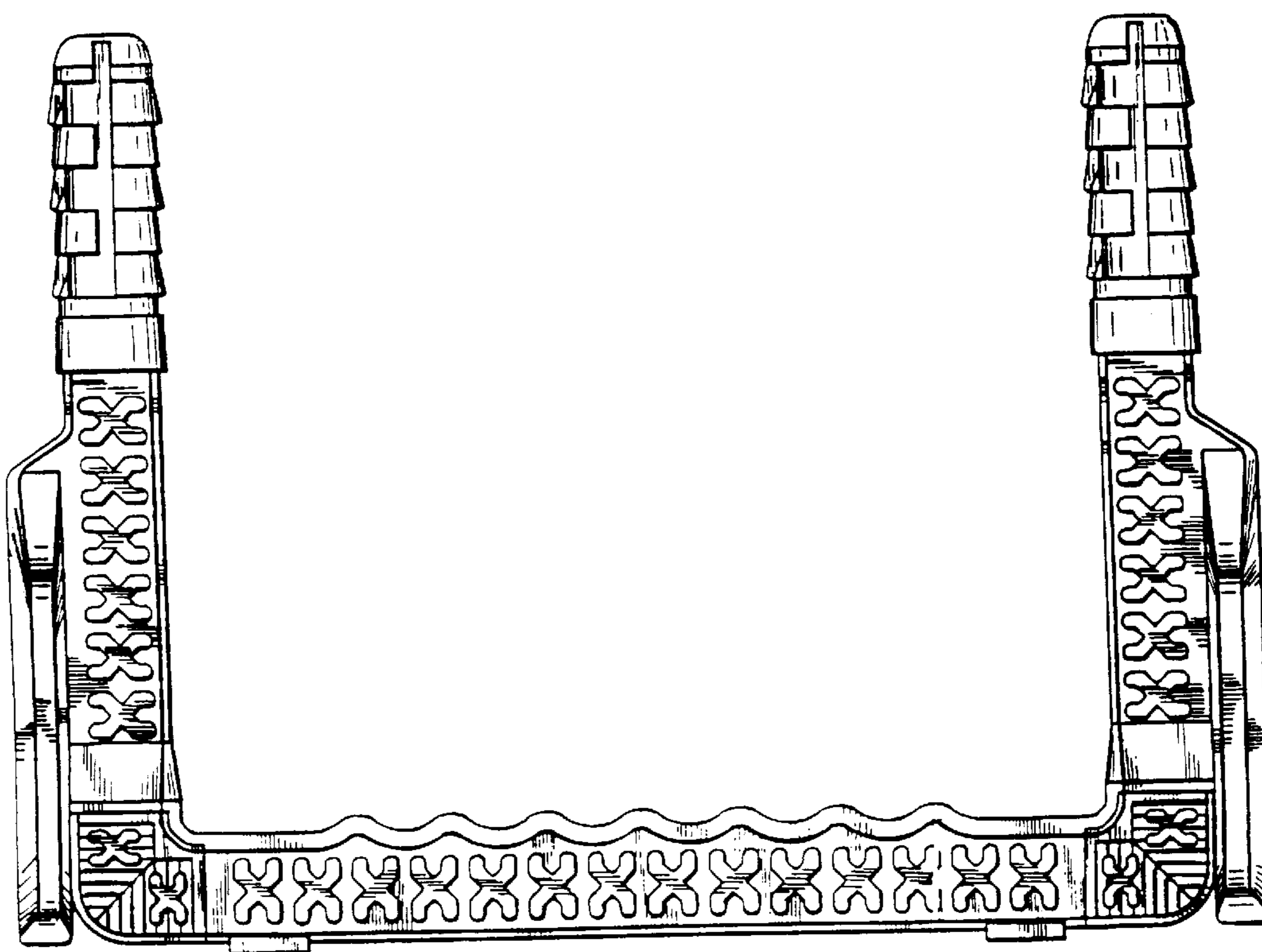

FIG. 11

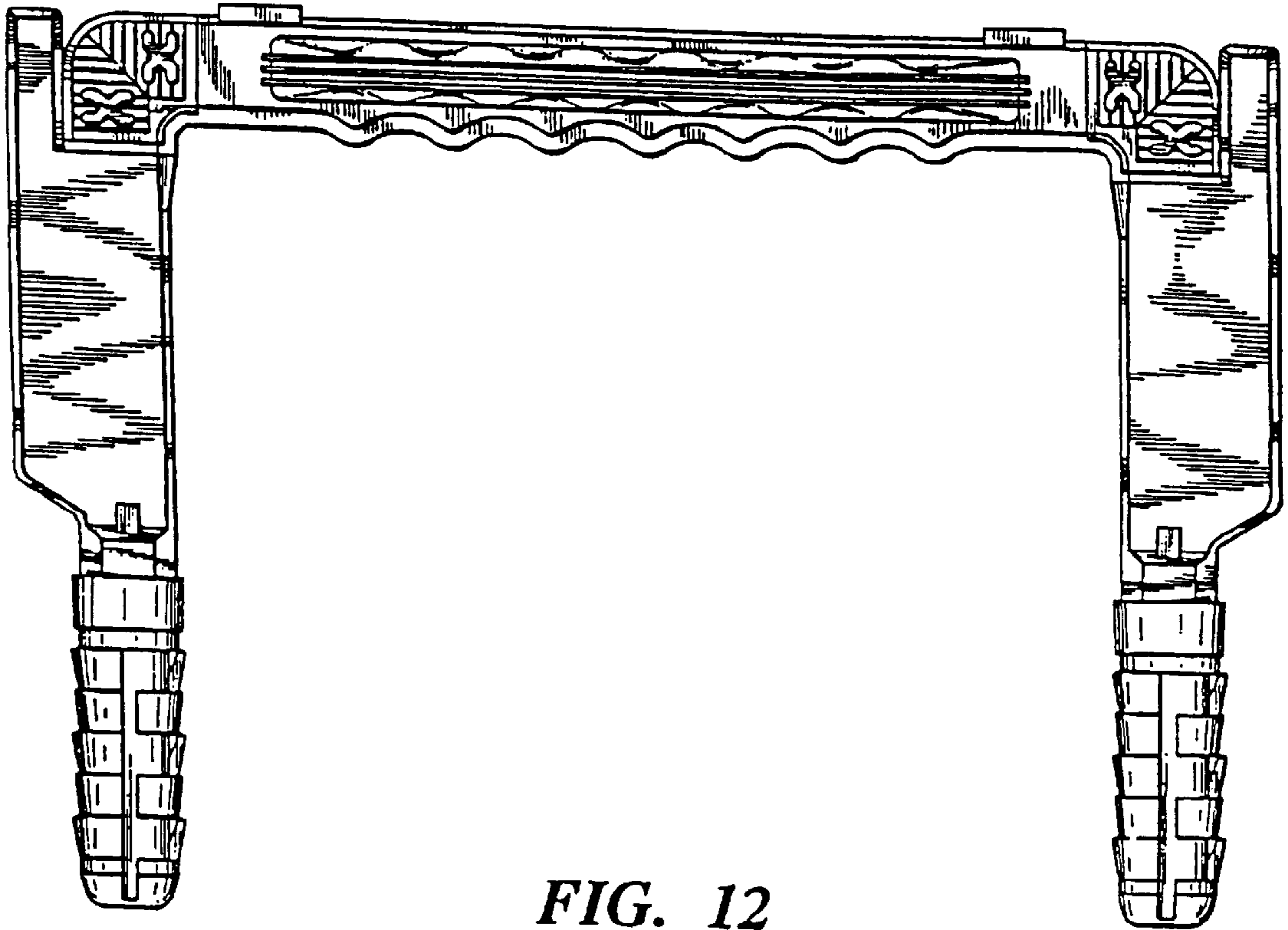

FIG. 12

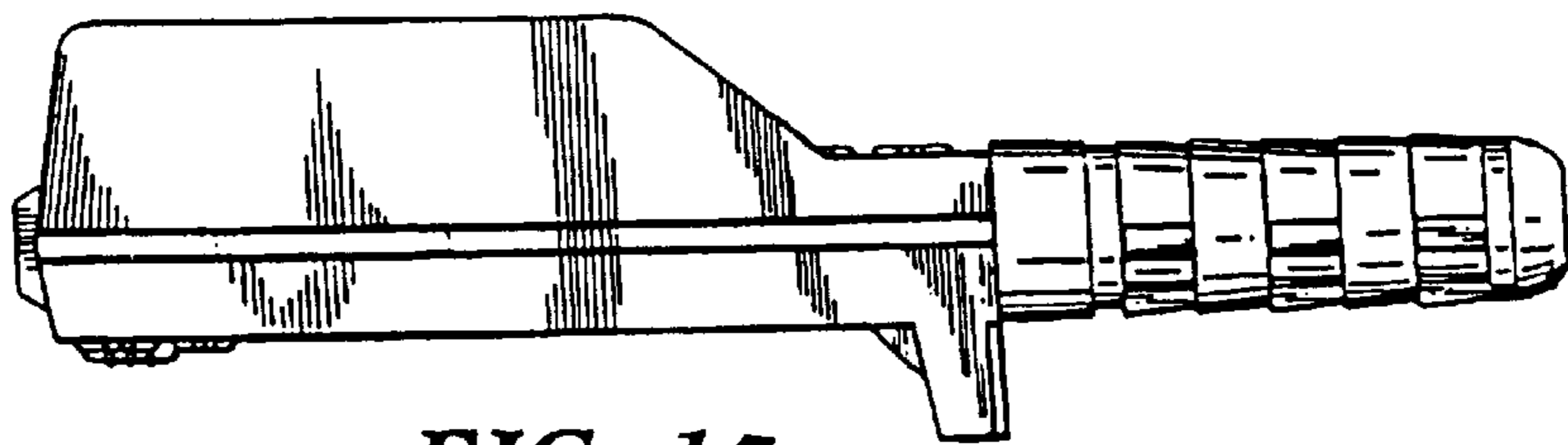

FIG. 15

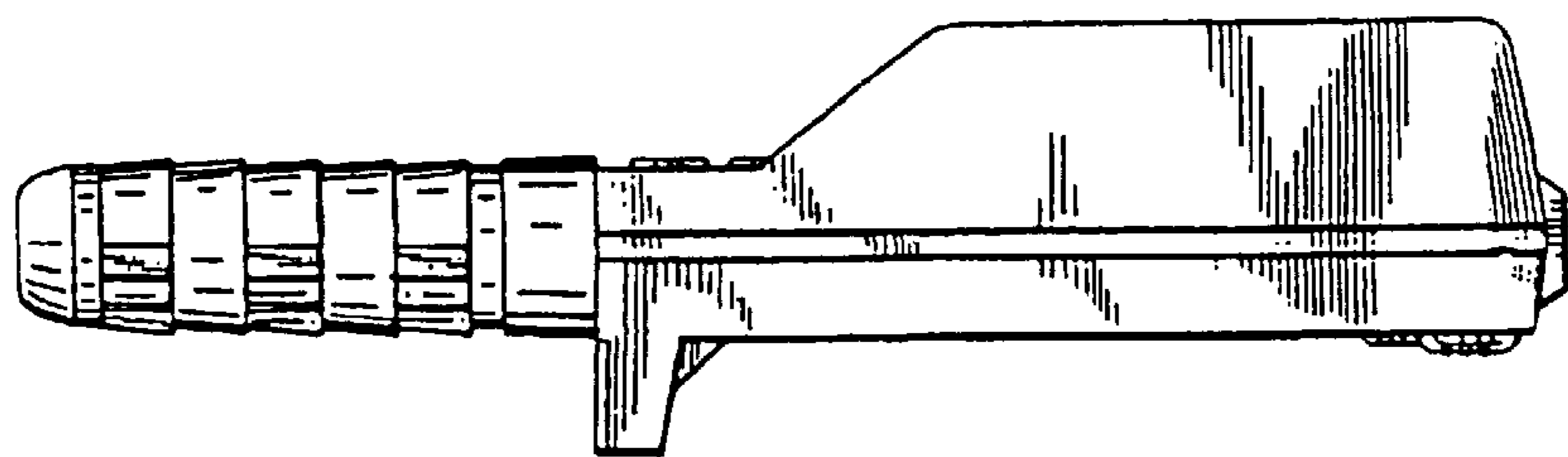

FIG. 16