



US00D435045S

United States Patent [19]
Treadwell

[11] **Patent Number: Des. 435,045**

[45] **Date of Patent: ** Dec. 12, 2000**

[54] **DATA INPUT DEVICE**

[75] Inventor: **Simon Treadwell**, Etobicoke, Canada

[73] Assignee: **Morphometrix Technologies Inc.**,
Canada

[**] Term: **14 Years**

[21] Appl. No.: **29/113,017**

[22] Filed: **Oct. 28, 1999**

[51] **LOC (7) Cl.** **14-02**

[52] **U.S. Cl.** **D14/402; D14/404; D14/417**

[58] **Field of Search** D14/402-410,
D14/417, 432; 200/5 R, 5 A, 6 R, 6 A;
273/148 B; 345/156-167; 74/471 XY; 463/36,
37, 38

[56] **References Cited**

U.S. PATENT DOCUMENTS

- D. 309,449 7/1990 MacDonald et al. D14/404
- D. 363,710 10/1995 Mateus et al. D14/417
- D. 368,721 4/1996 Howell et al. D14/410

D. 398,912 9/1998 Phillips D14/417

Primary Examiner—Kay H. Chin
Attorney, Agent, or Firm—Lerner, David, Littenberg,
Krumholz & Mentlik, LLP

[57] **CLAIM**

The ornamental design for a data input device, as shown and described.

DESCRIPTION

FIG. 1 is a top right perspective view of a data input device, the broken lines are for illustrative purposes only and form no part of the claimed design;
FIG. 2 is a top plan view thereof;
FIG. 3 is a front elevational view thereof;
FIG. 4 is a rear elevational view thereof;
FIG. 5 is a right side elevational view thereof;
FIG. 6 is a left side elevational view thereof;
FIG. 7 is a bottom plan view thereof; and,
FIG. 8 is a top right perspective view thereof in an extended position.

1 Claim, 3 Drawing Sheets

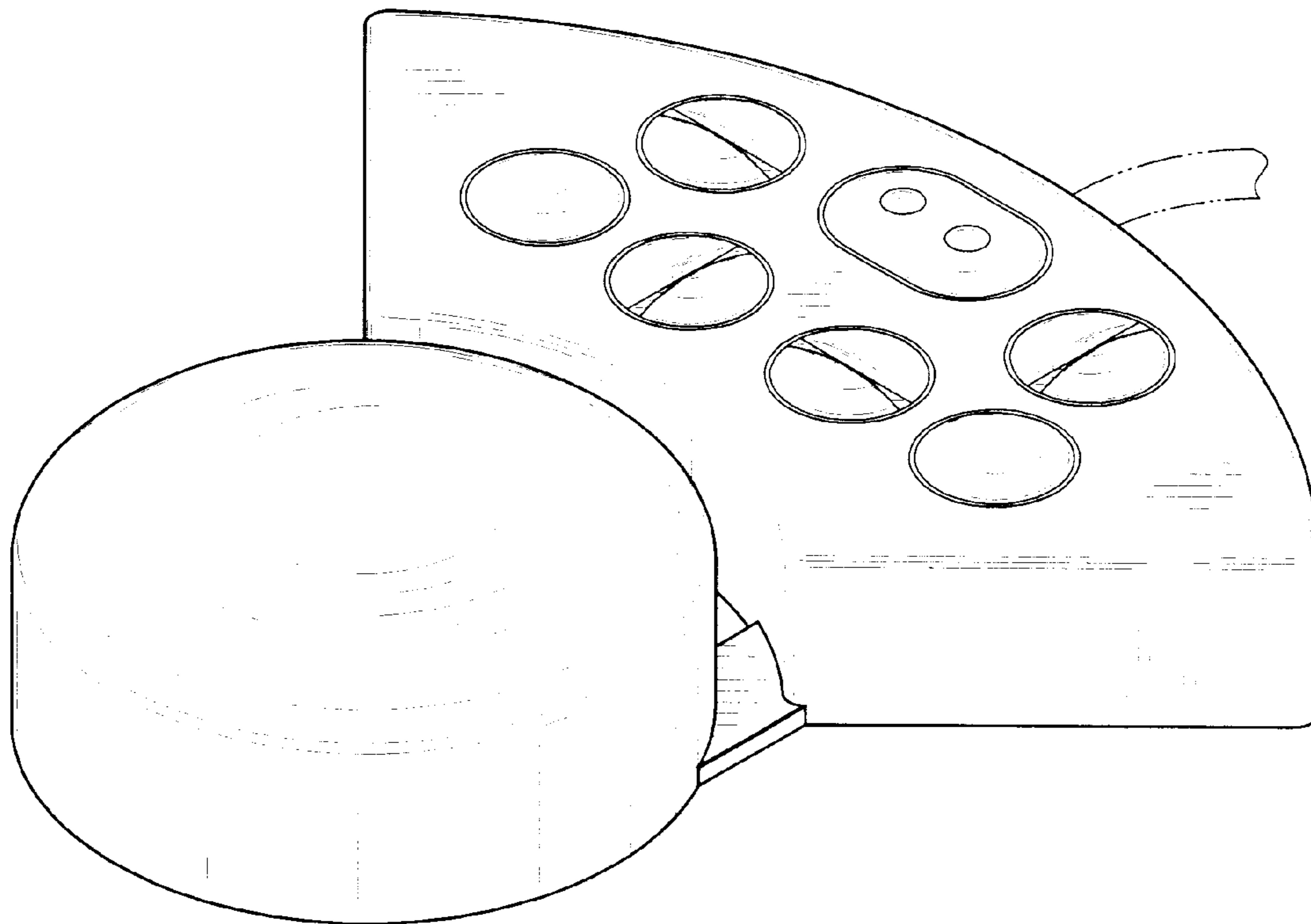

FIG. 1

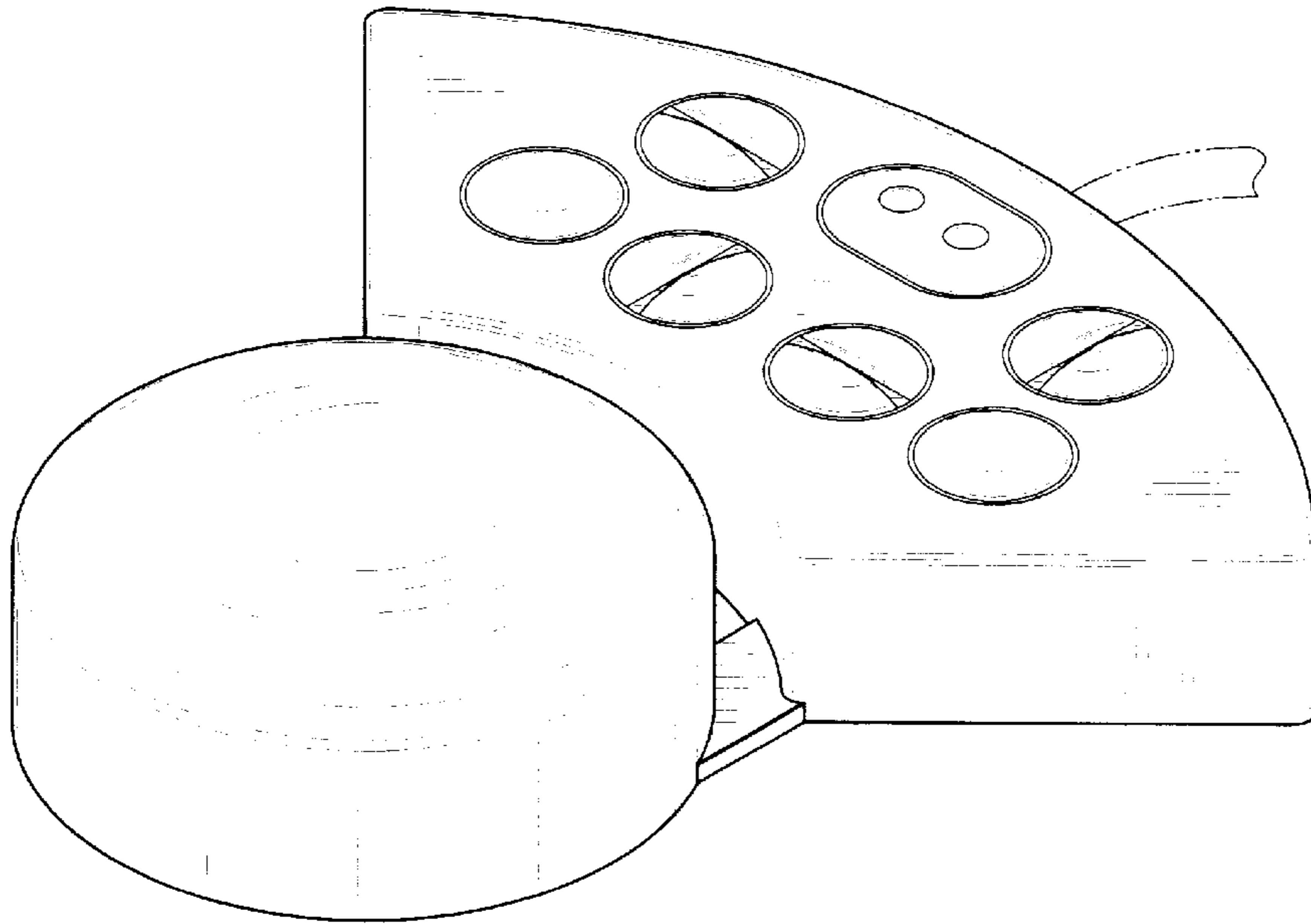

FIG. 2

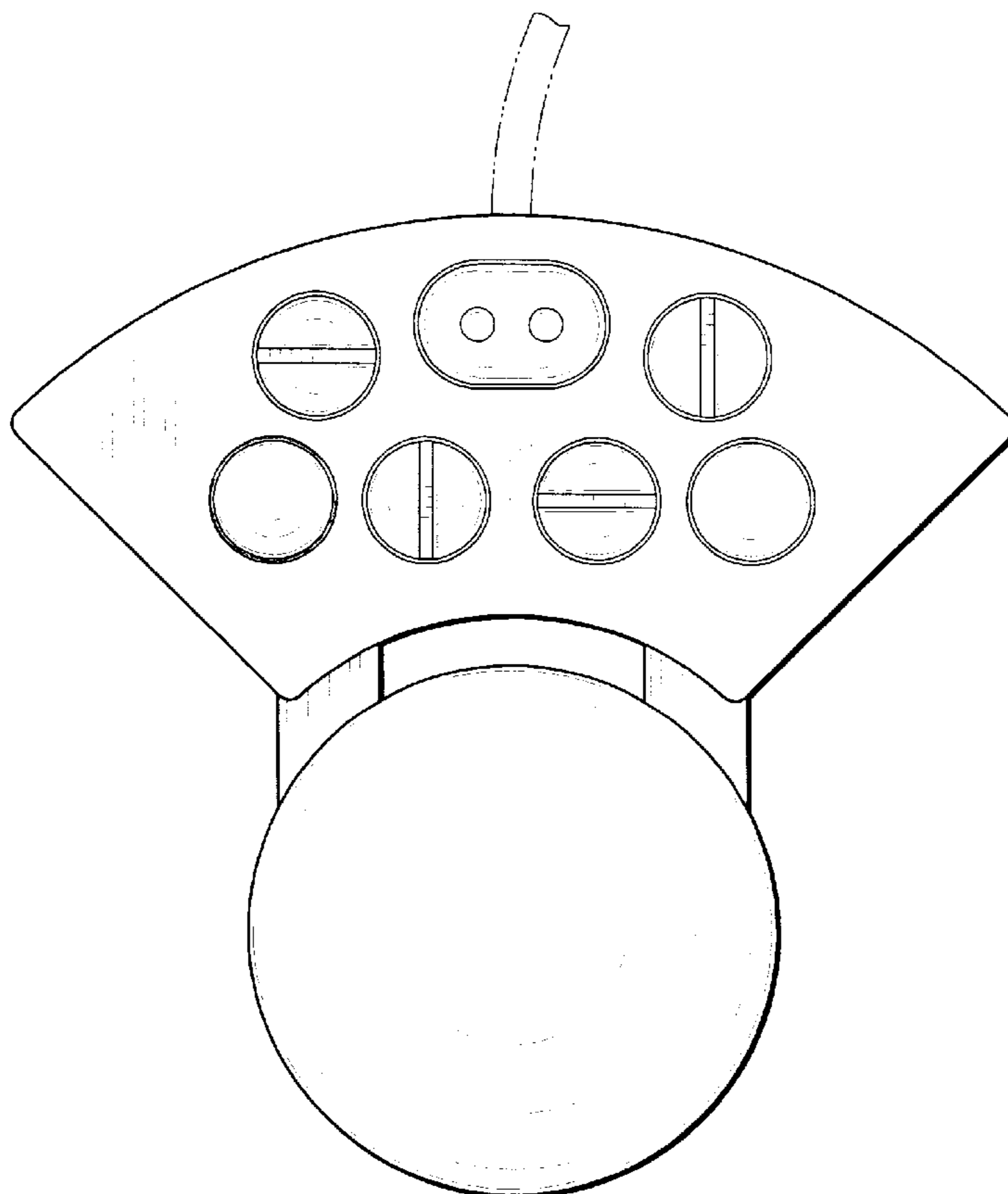

FIG. 3

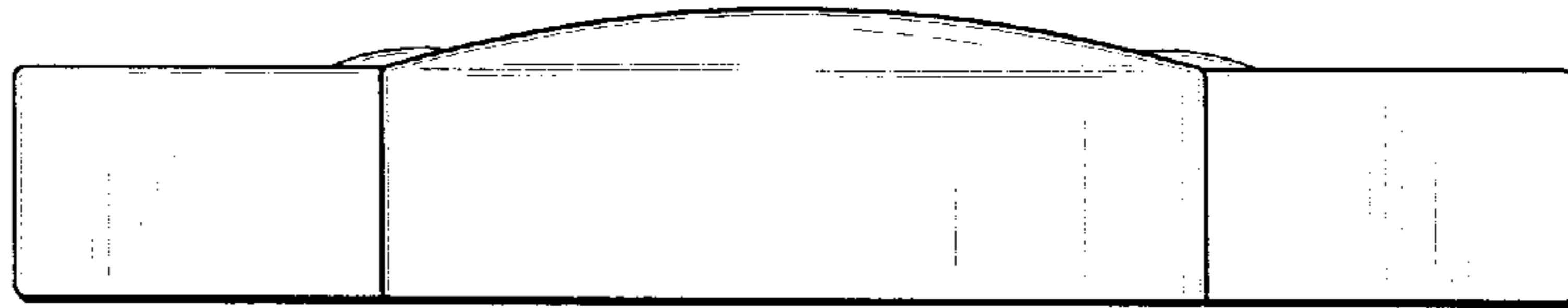

FIG. 4

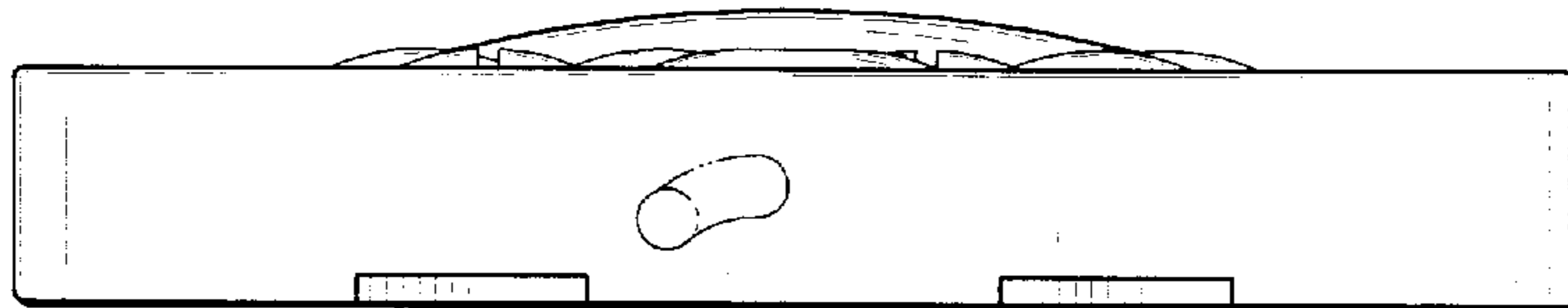

FIG. 5

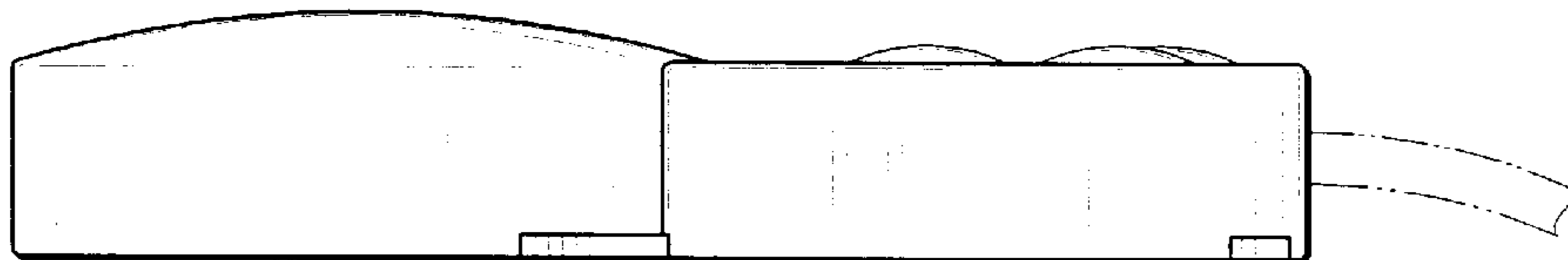

FIG. 6

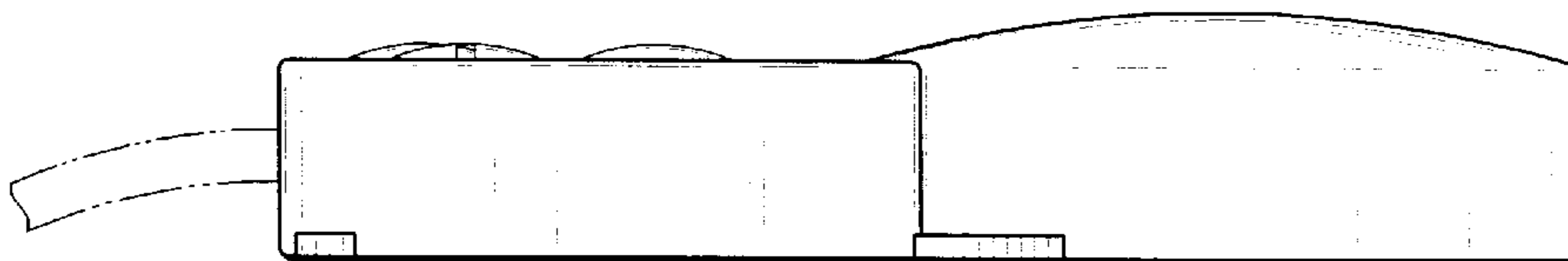

FIG. 7

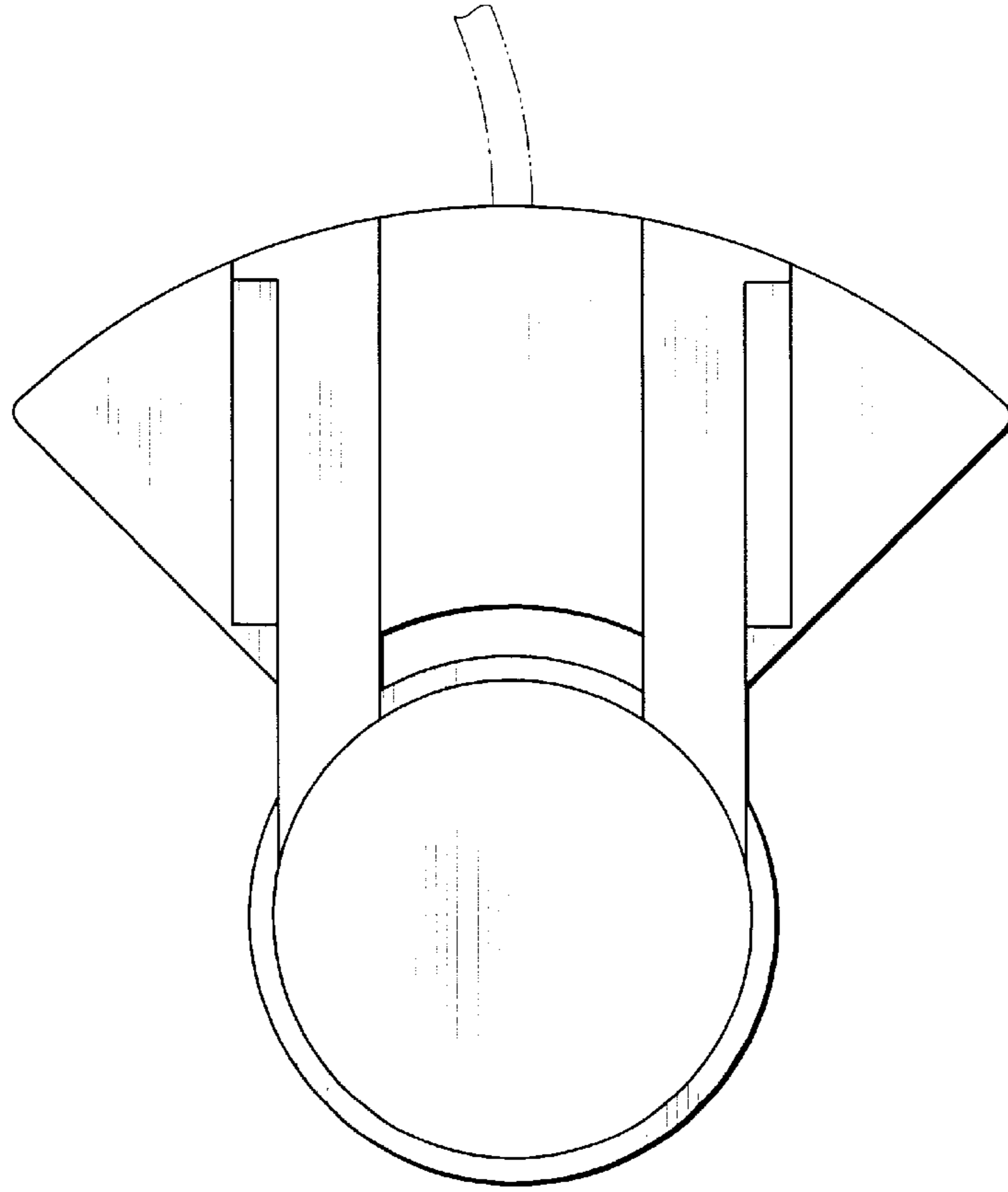
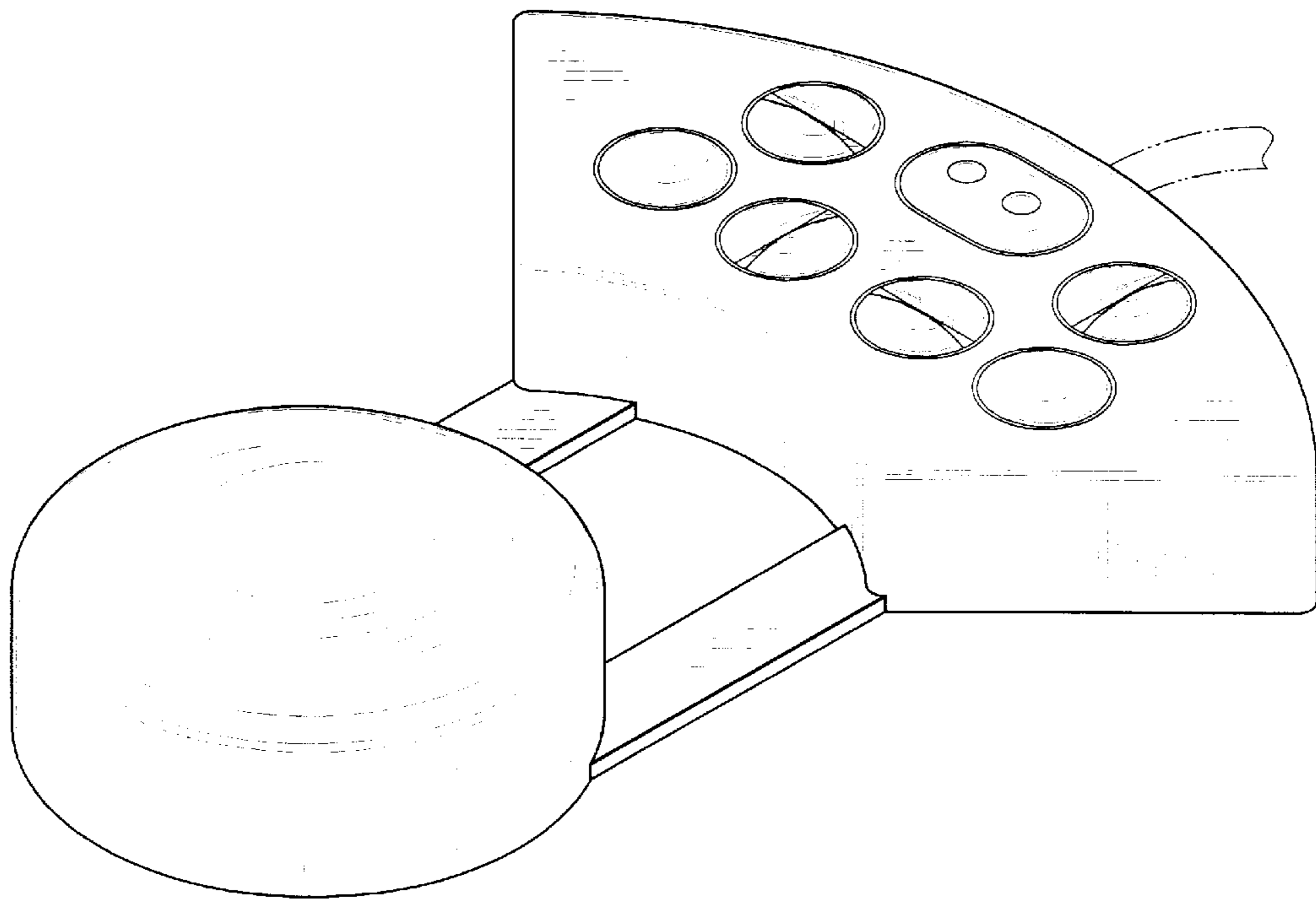

FIG. 8



UNITED STATES PATENT AND TRADEMARK OFFICE
CERTIFICATE OF CORRECTION

PATENT NO. : Des. 435,045
DATED : December 12, 2000
INVENTOR(S) : Treadwell

It is certified that error appears in the above-identified patent and that said Letters Patent is hereby corrected as shown below:

Cover page, [75], "Etobicoke," should read --Etobicoke, Ontario--

Signed and Sealed this
Fifteenth Day of May, 2001



Attest:

NICHOLAS P. GODICI

Attesting Officer

Acting Director of the United States Patent and Trademark Office