



US00D435038S

United States Patent [19]
Lohrding et al.

[11] **Patent Number: Des. 435,038**

[45] **Date of Patent: ** Dec. 12, 2000**

[54] **RADIOTELEPHONE ANTENNA**

[75] Inventors: **Bradley Keith Lohrding**, Gurnee;
Galina Treyer, Northbrook, both of Ill.

[73] Assignee: **Motorola, Inc.**, Schaumburg, Ill.

[**] Term: **14 Years**

[21] Appl. No.: **29/112,101**

[22] Filed: **Oct. 8, 1999**

[51] **LOC (7) Cl.** **14-03**

[52] **U.S. Cl.** **D14/234; D14/230**

[58] **Field of Search** **D14/230-238;**
343/702, 901, 720, 713, 714, 795, 765,
840, 872, 878, 879; 455/90, 347, 128, 562

[56] **References Cited**

U.S. PATENT DOCUMENTS

D. 357,683	4/1995	Cline et al.	D14/234
D. 367,655	3/1996	Rak	D14/234
D. 412,709	8/1999	Lohrding et al. .	
5,559,522	9/1996	Seiz	343/702
5,576,720	11/1996	Gorenz Jr. et al.	343/702

Primary Examiner—Louis S. Zarfaz
Assistant Examiner—Gregory Andoll
Attorney, Agent, or Firm—Lalita P. Williams

[57] **CLAIM**

The ornamental design for a radiotelephone antenna, as shown and described.

DESCRIPTION

FIG. 1 is a top, left and front perspective view of the radiotelephone antenna showing my new design in the retracted position;

FIG. 2 is a top, left and front perspective view of the radiotelephone antenna shown in FIG. 1 in the extended position;

FIG. 3 is a left side elevational view of the radiotelephone antenna shown in FIG. 1;

FIG. 4 is a front elevational view of the radiotelephone antenna shown in FIG. 1;

FIG. 5 is a bottom elevational view of the radiotelephone antenna shown in FIG. 1;

FIG. 6 is a top elevational view of the radiotelephone antenna shown in FIG. 1;

FIG. 7 is a right side elevational view of the radiotelephone antenna shown in FIG. 1; and,

FIG. 8 is a rear elevational view of the radiotelephone antenna shown in FIG. 1.

The broken lines in the Figures are for illustrative purposes only and form no part of the claimed design.

The surfaces of the article when in the extended position that are not shown in the drawing or described in the specification form no part of the claimed design.

1 Claim, 3 Drawing Sheets

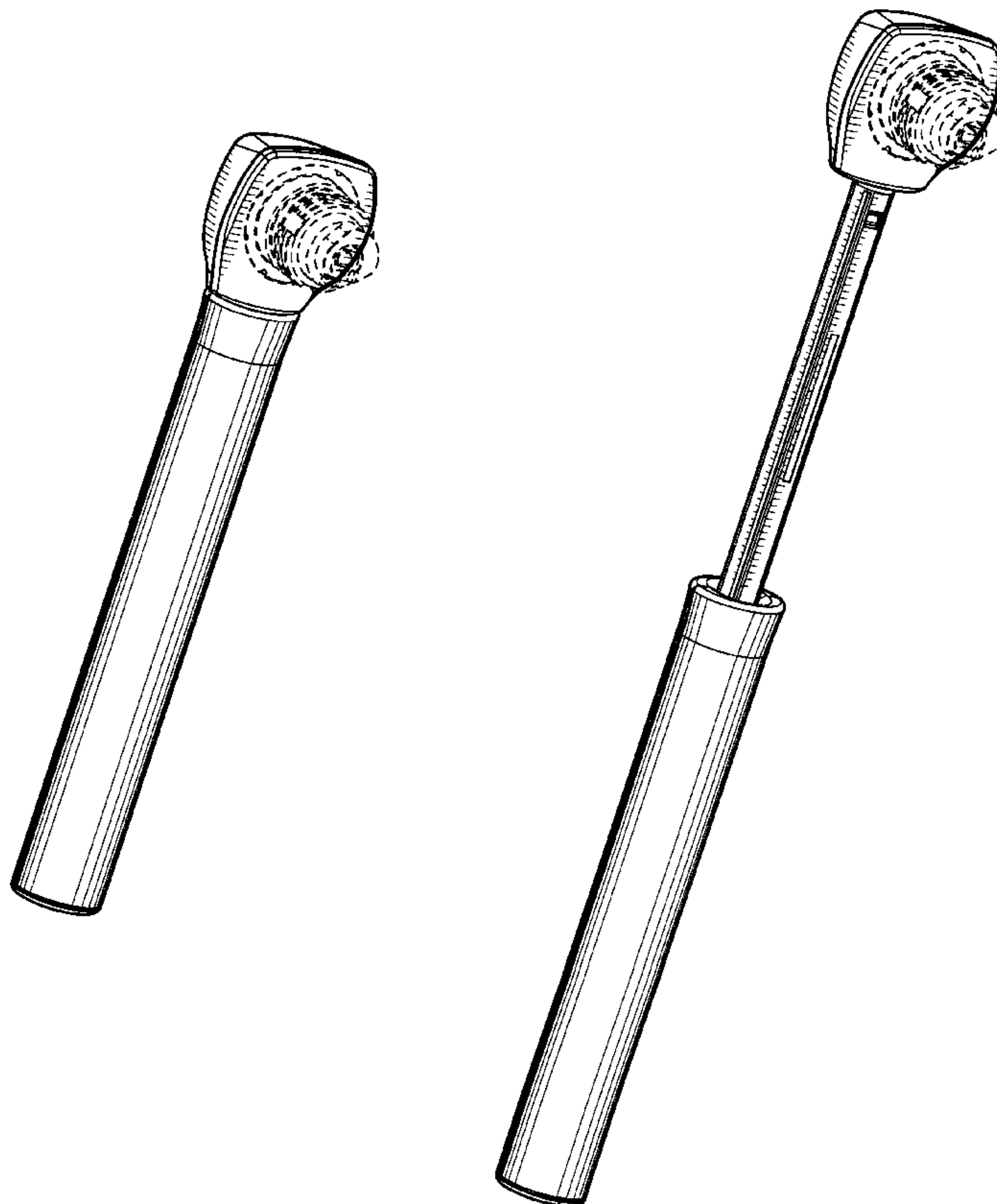

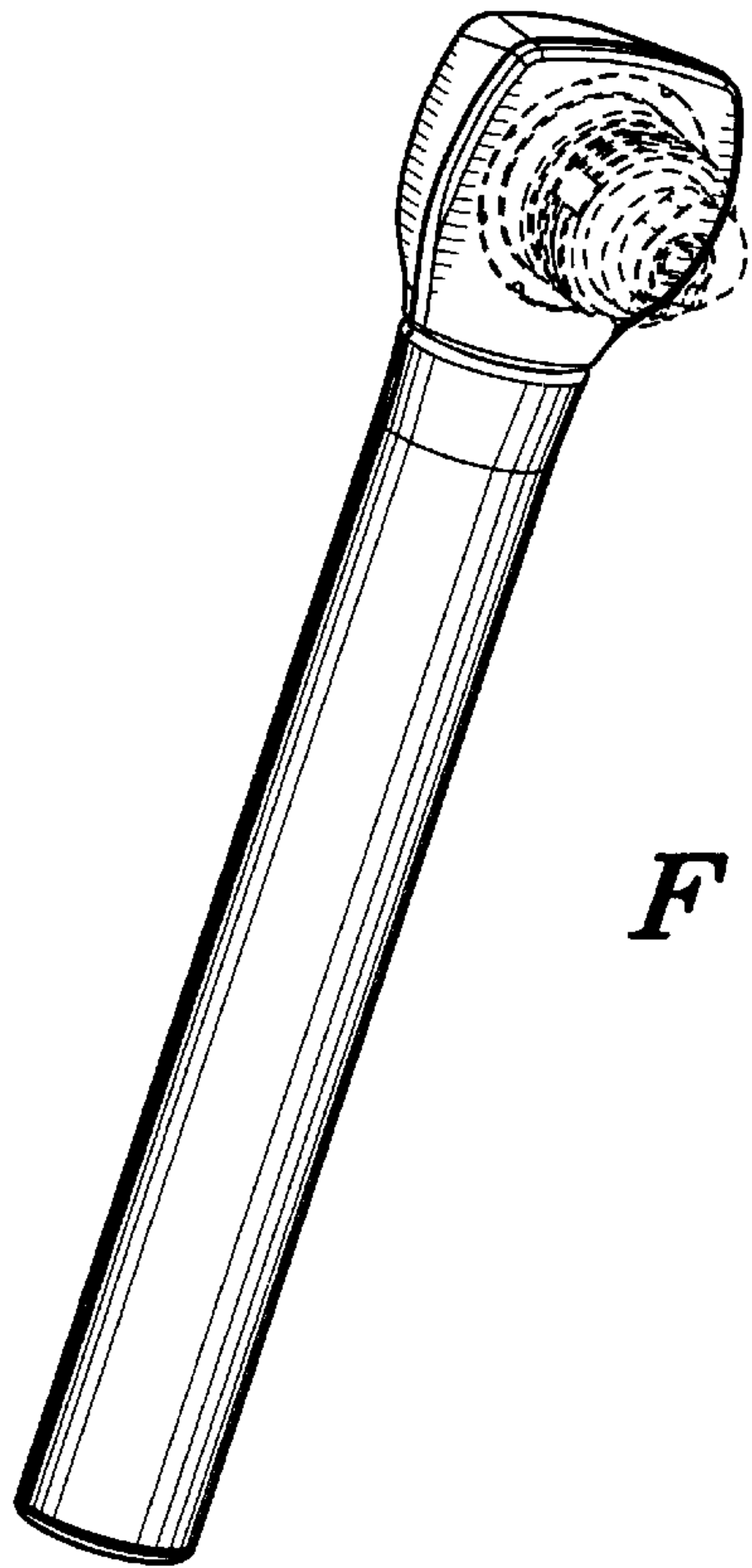

FIG. 1

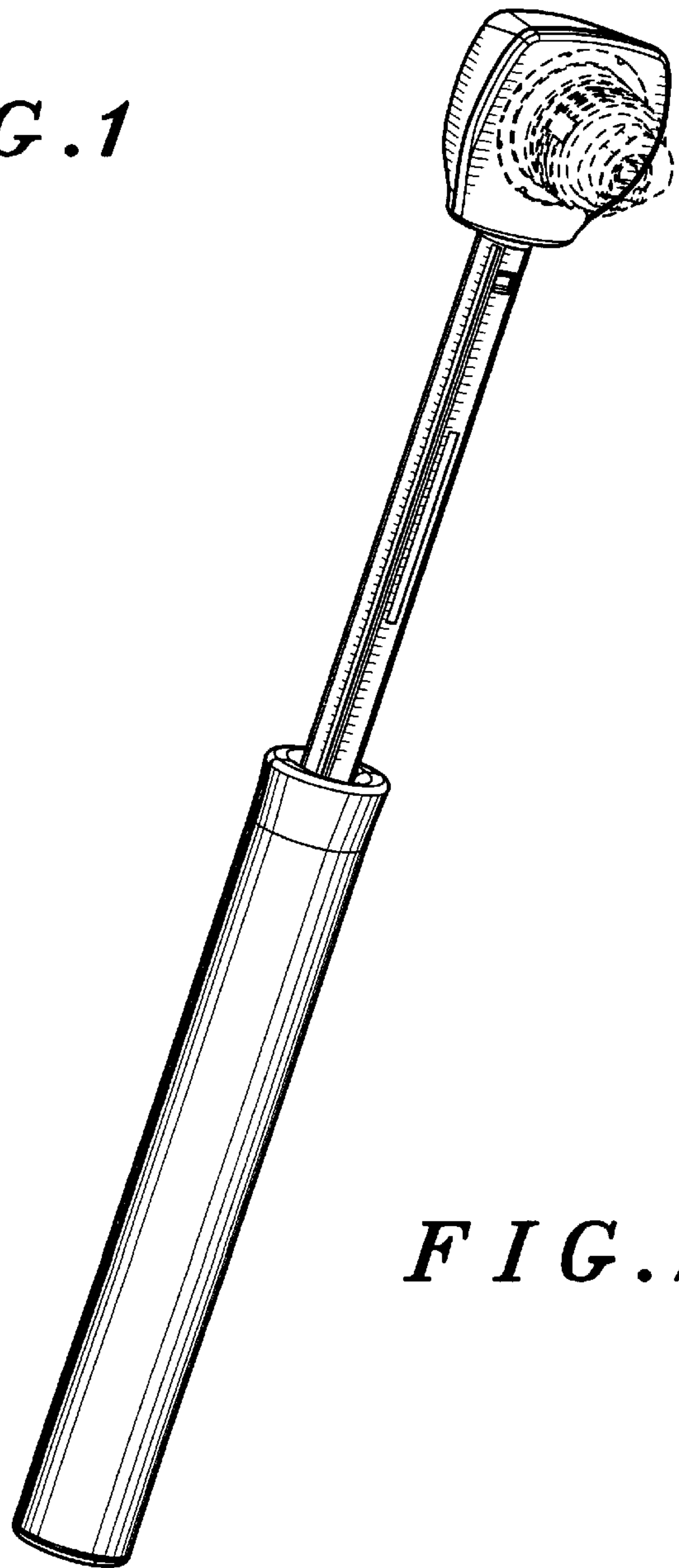

FIG. 2

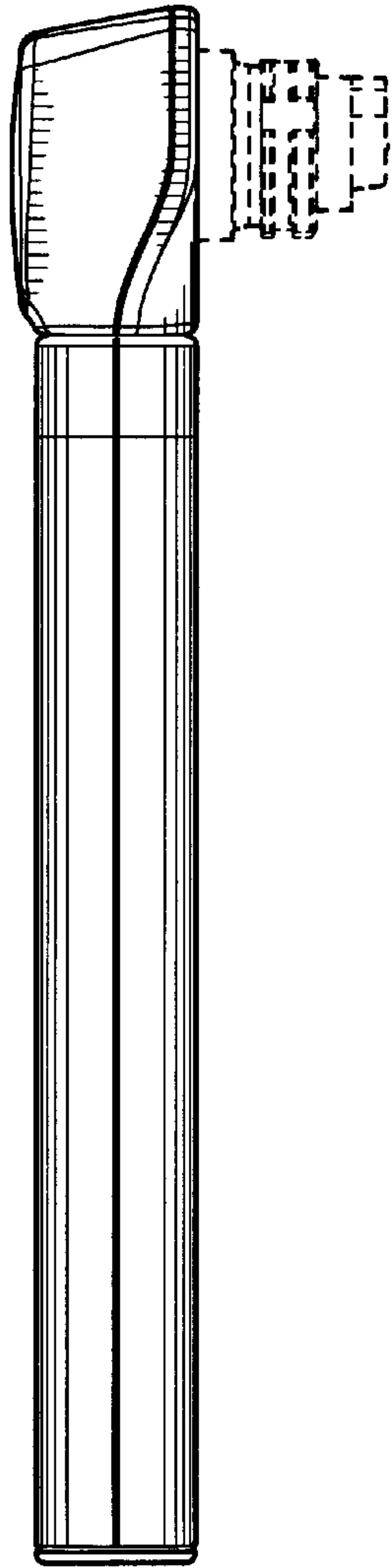

FIG. 3

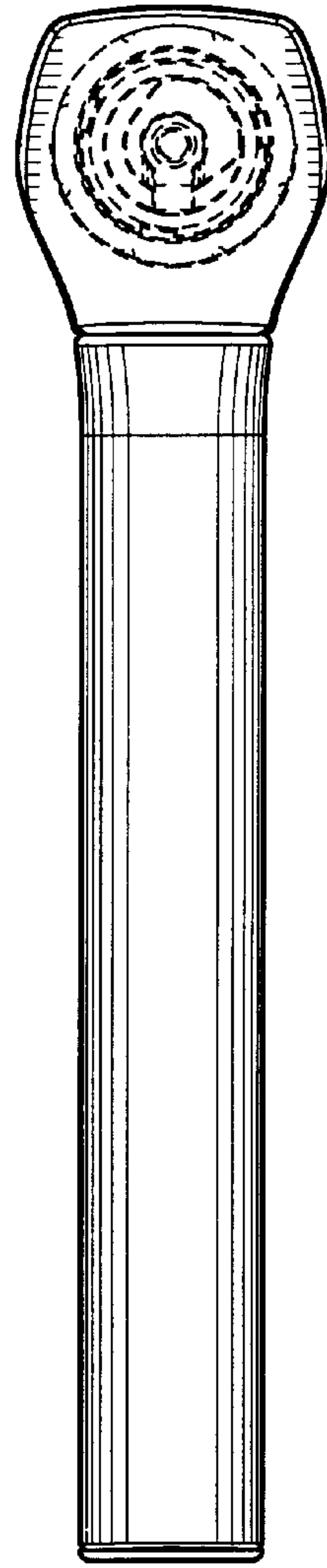

FIG. 4

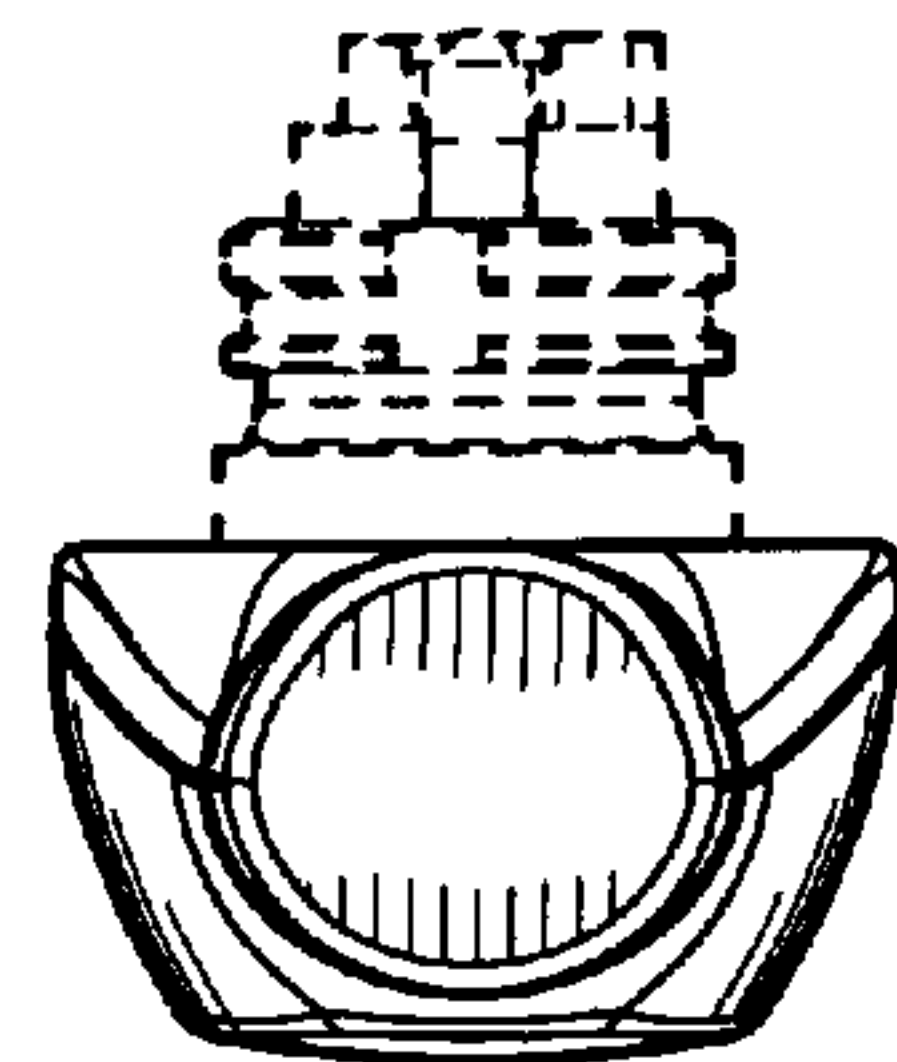

FIG. 5

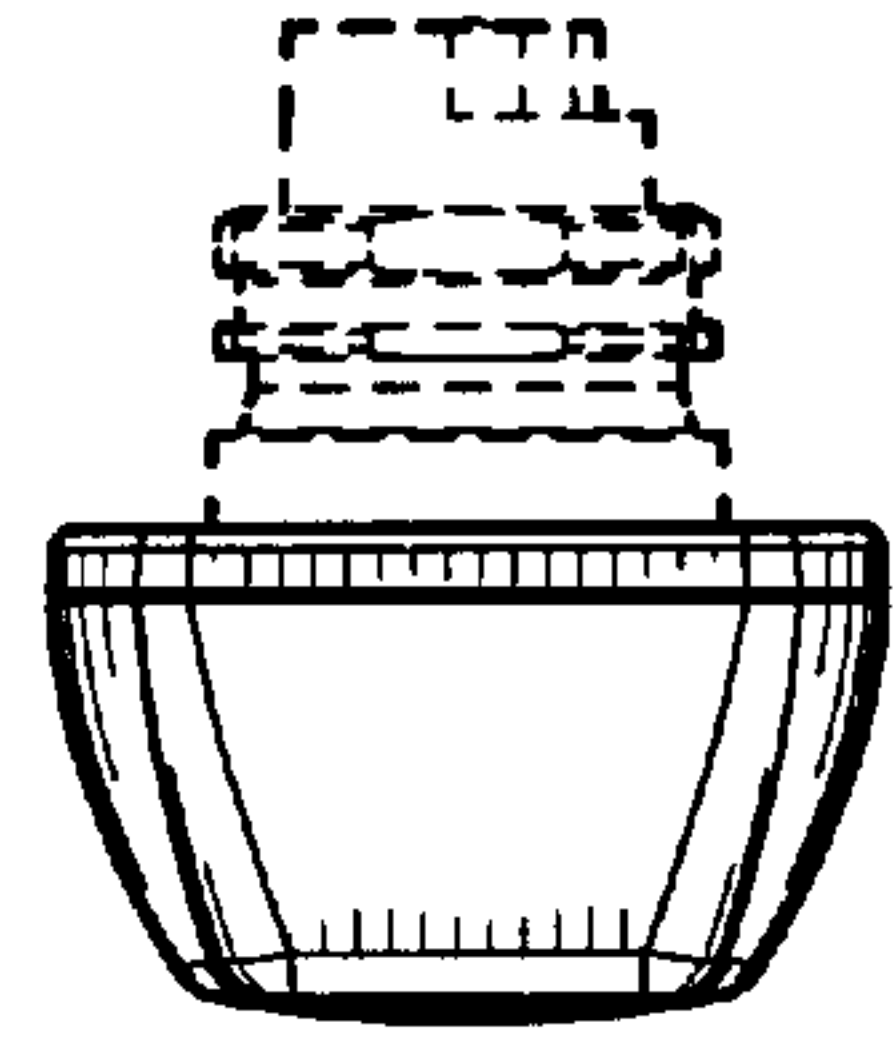

FIG. 6

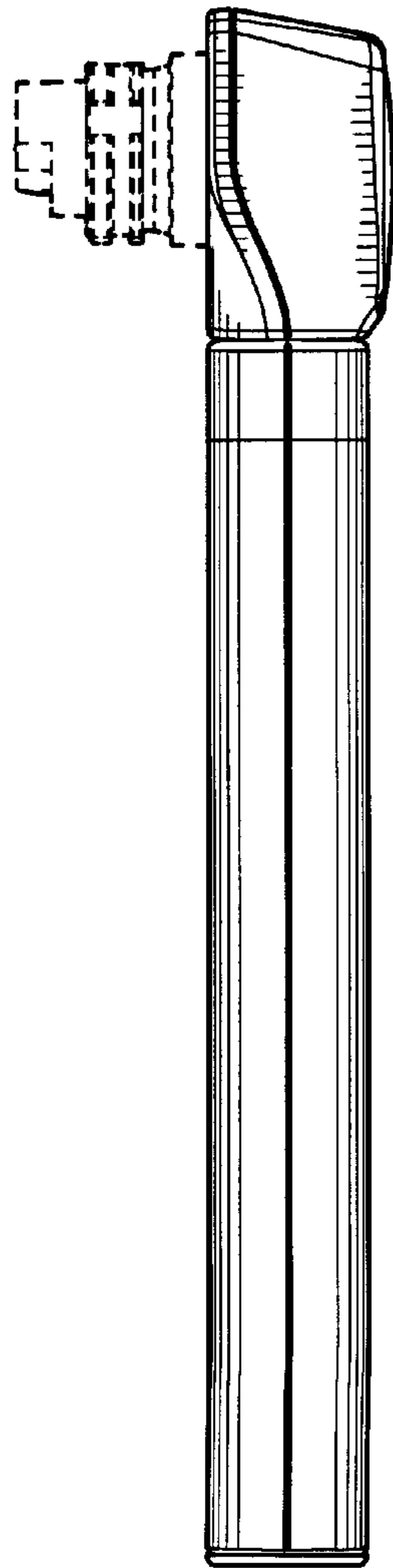

FIG. 7

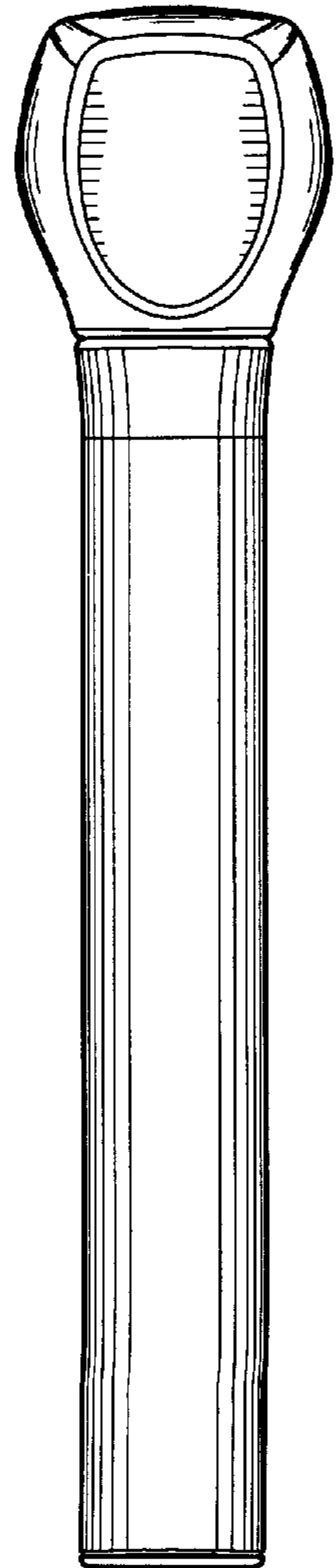

FIG. 8