



US00D435031S

United States Patent [19] Uchiyama

[11] Patent Number: Des. 435,031

[45] Date of Patent: ** Dec. 12, 2000

[54] COMBINED DISC AND TAPE PLAYER

5,593,220 1/1997 Seid et al. 361/724 X

[75] Inventor: Jun Uchiyama, Tokyo, Japan

OTHER PUBLICATIONS

[73] Assignee: Sony Corporation, Japan

Catalog "87", pp. 31, 32, 33, 133 and 134, Sony (Nov. 1997).

[**] Term: 14 Years

Primary Examiner—Nanda Bondade
Attorney, Agent, or Firm—Rader, Fishman & Grauer

[21] Appl. No.: 29/101,113

[22] Filed: Feb. 23, 1999

[57] CLAIM

The ornamental design for a combined disc and tape player, as shown and described.

Related U.S. Application Data

DESCRIPTION

[62] Division of application No. 29/082,781, Jan. 30, 1998, Pat. No. Des. 412,905.

FIG. 1 is a perspective view of a combined disc and tape player showing our new design;

[51] LOC (7) Cl. 14-01

FIG. 2 is a top plan view thereof;

[52] U.S. Cl. D14/156

FIG. 3 is a left side elevational view thereof;

[58] Field of Search D14/135, 136, D14/156, 157, 160-168, 257, 258; 369/75.1, 75.2, 77.1, 77.2

FIG. 4 is a rear elevational view thereof;

FIG. 5 is a front elevational view thereof;

FIG. 6 is a bottom plan view thereof;

FIG. 7 is a right side elevational view thereof;

[56] References Cited

U.S. PATENT DOCUMENTS

D. 321,191	10/1991	Ito et al.	D14/136 X
D. 339,134	9/1993	Ito et al.	D14/156
D. 339,135	9/1993	Ito et al.	D14/156
D. 344,941	3/1994	Ogawa et al.	D14/135
D. 379,625	6/1997	Uchiyama	D14/156
D. 387,755	12/1997	Shintani	D14/135
D. 404,031	1/1999	Uchiyama	D14/156
4,561,085	12/1985	Funabashi	D14/156 X
5,177,730	1/1993	Utsugi	369/75.1

FIG. 8 is a perspective view of a second embodiment of a combined disc and tape player showing our new design;

FIG. 9 is a top plan view thereof;

FIG. 10 is a left side elevational view thereof;

FIG. 11 is a rear elevational view thereof;

FIG. 12 is a front elevational view thereof;

FIG. 13 is a bottom plan view thereof; and,

FIG. 14 is a right side elevational view thereof.

1 Claim, 6 Drawing Sheets

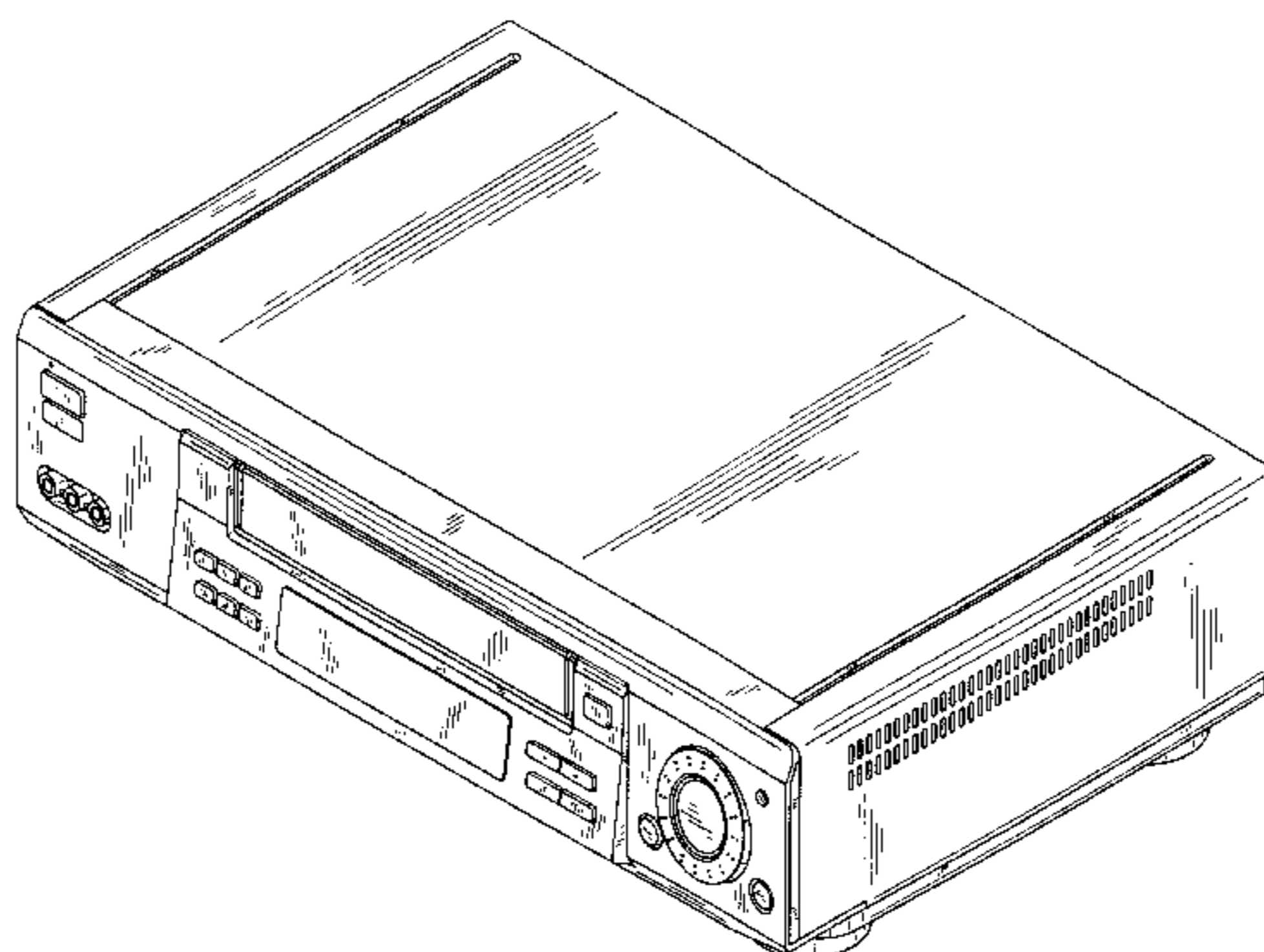
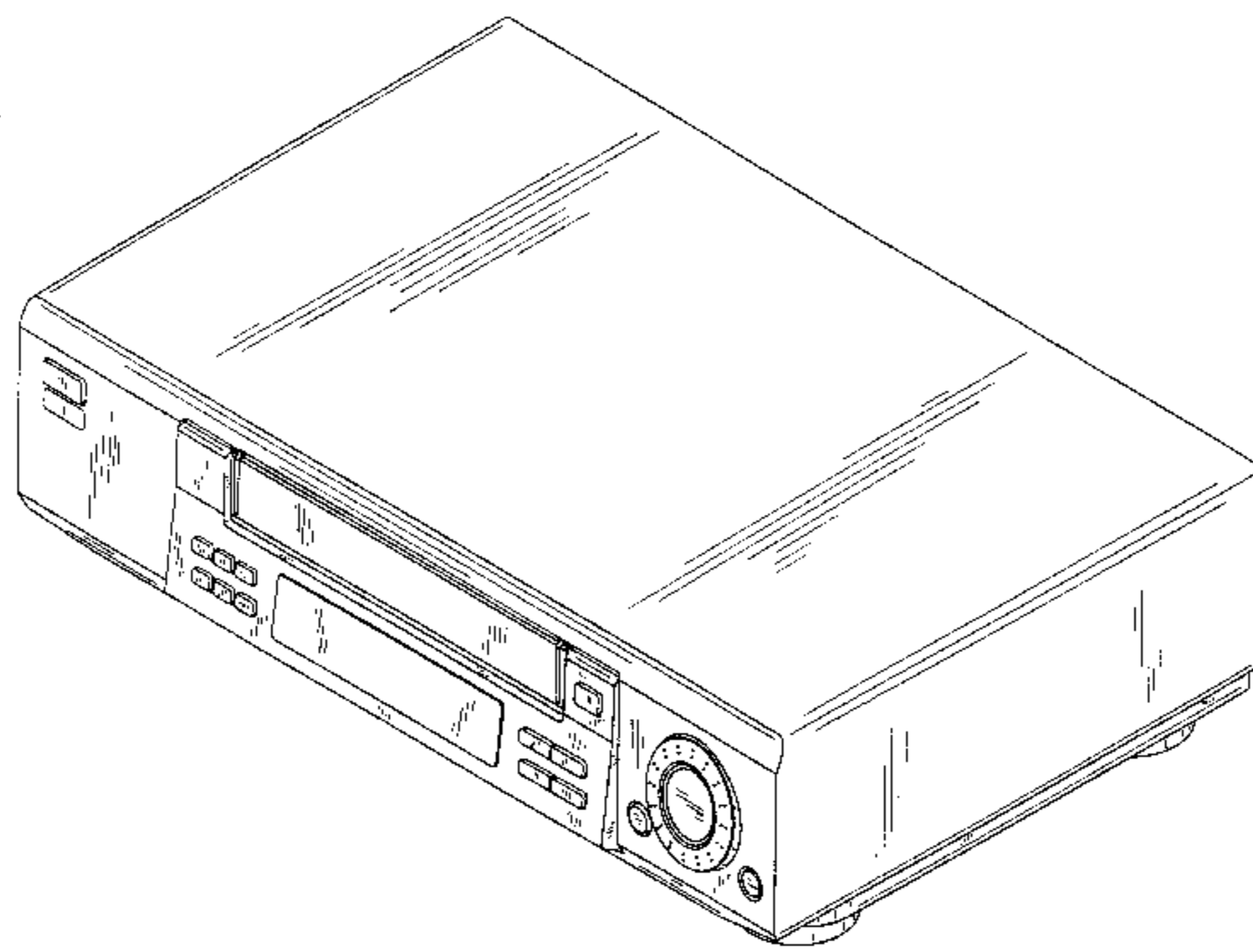

FIG. 1

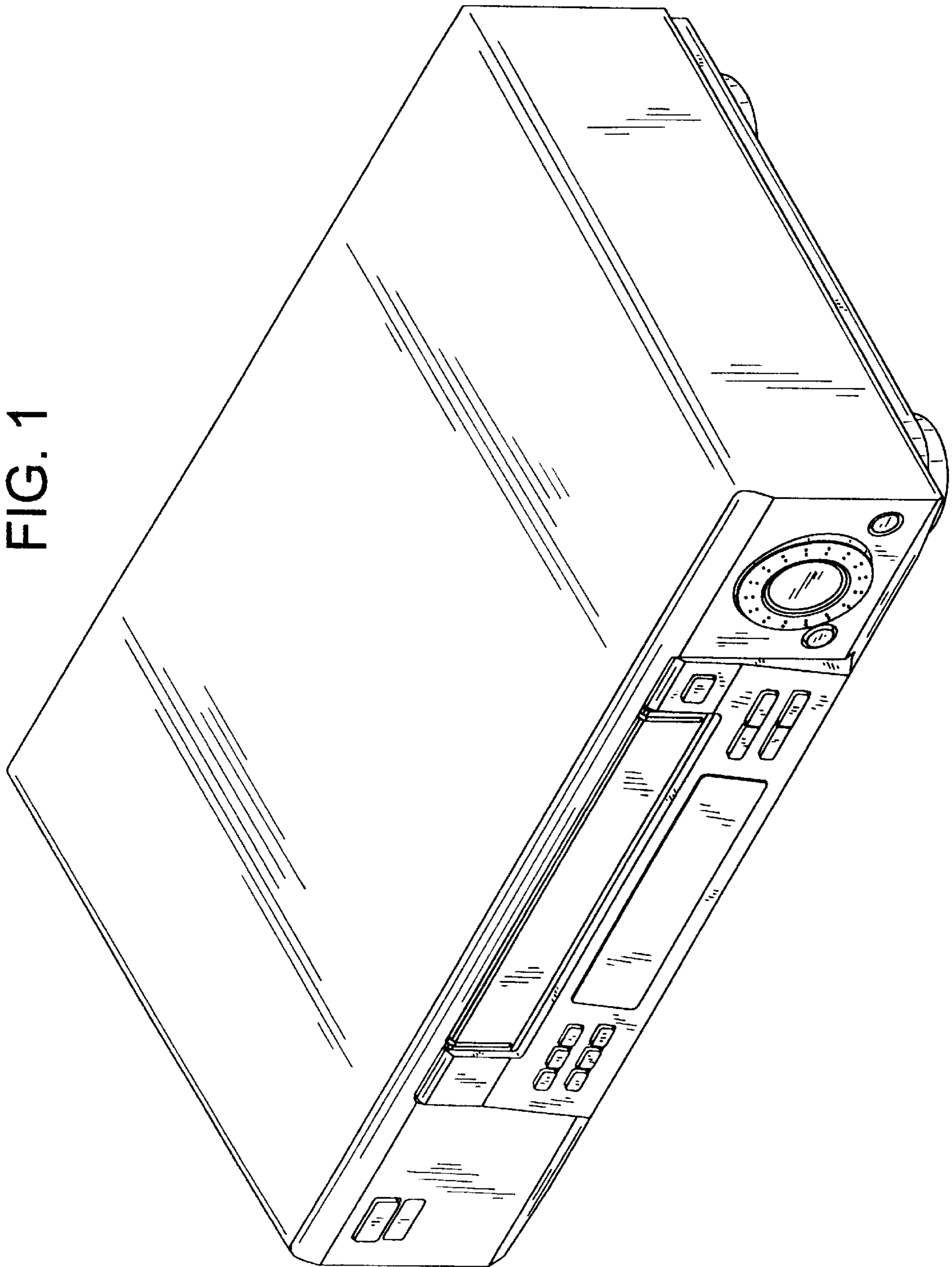

FIG. 2

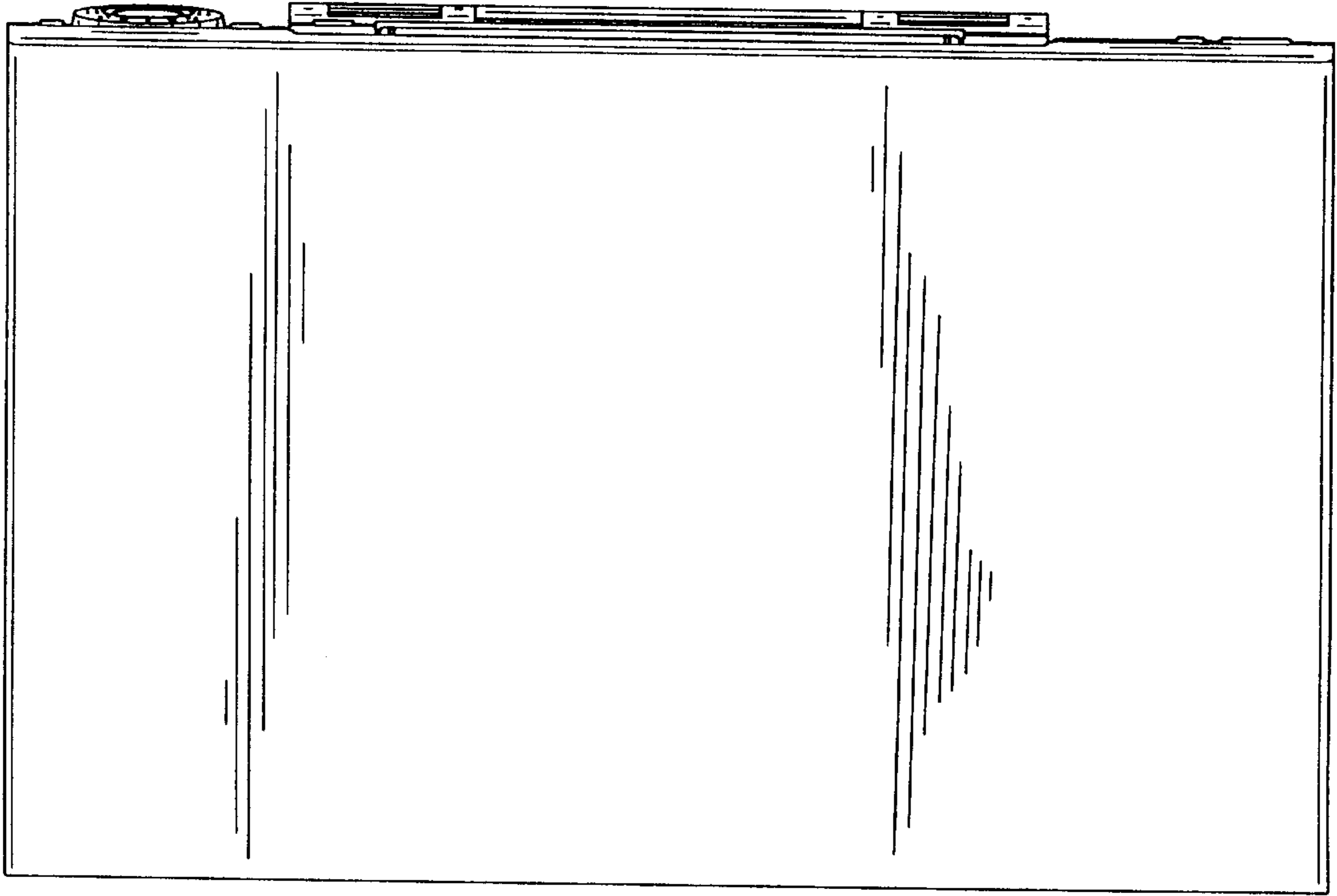

FIG. 6

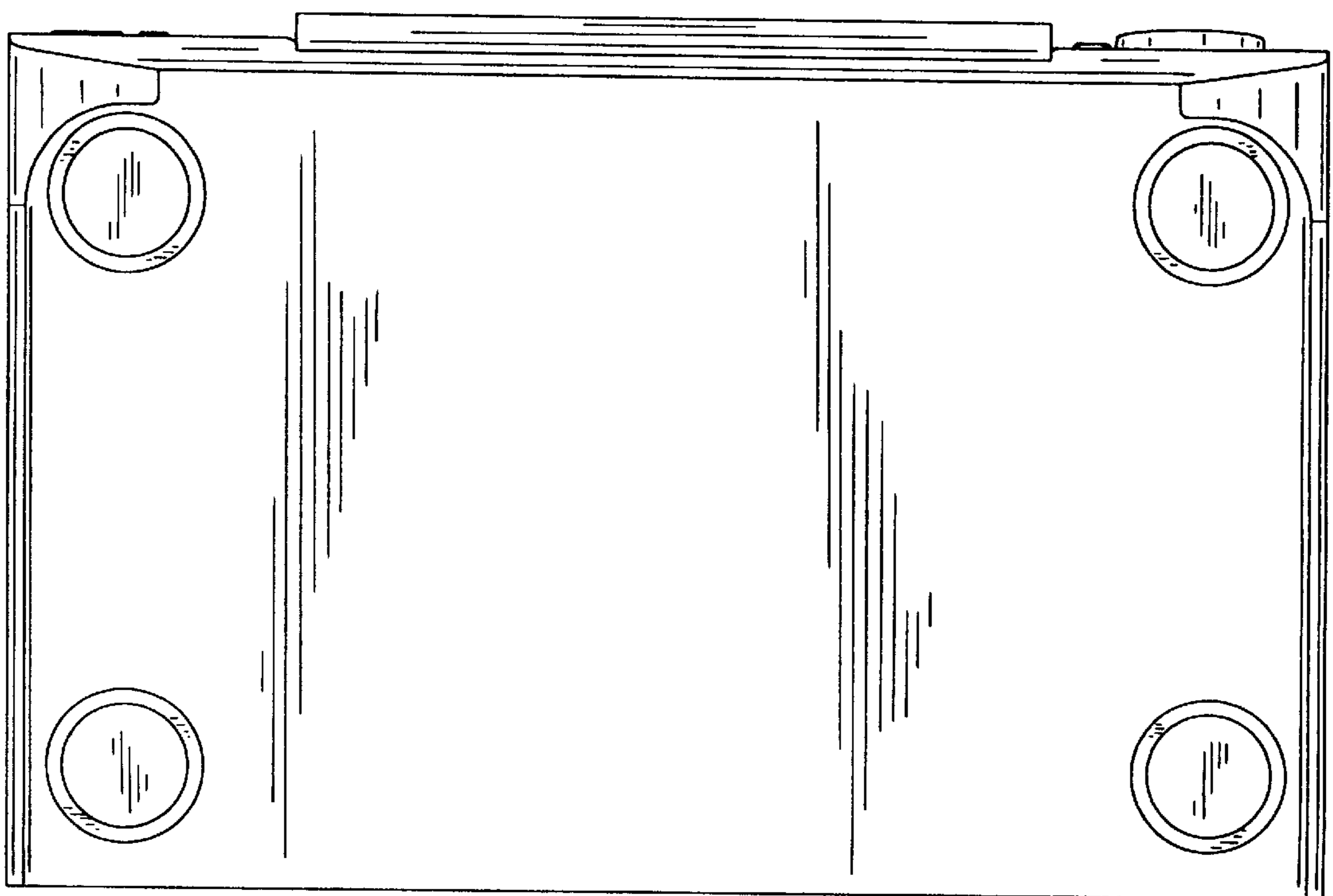

FIG. 3

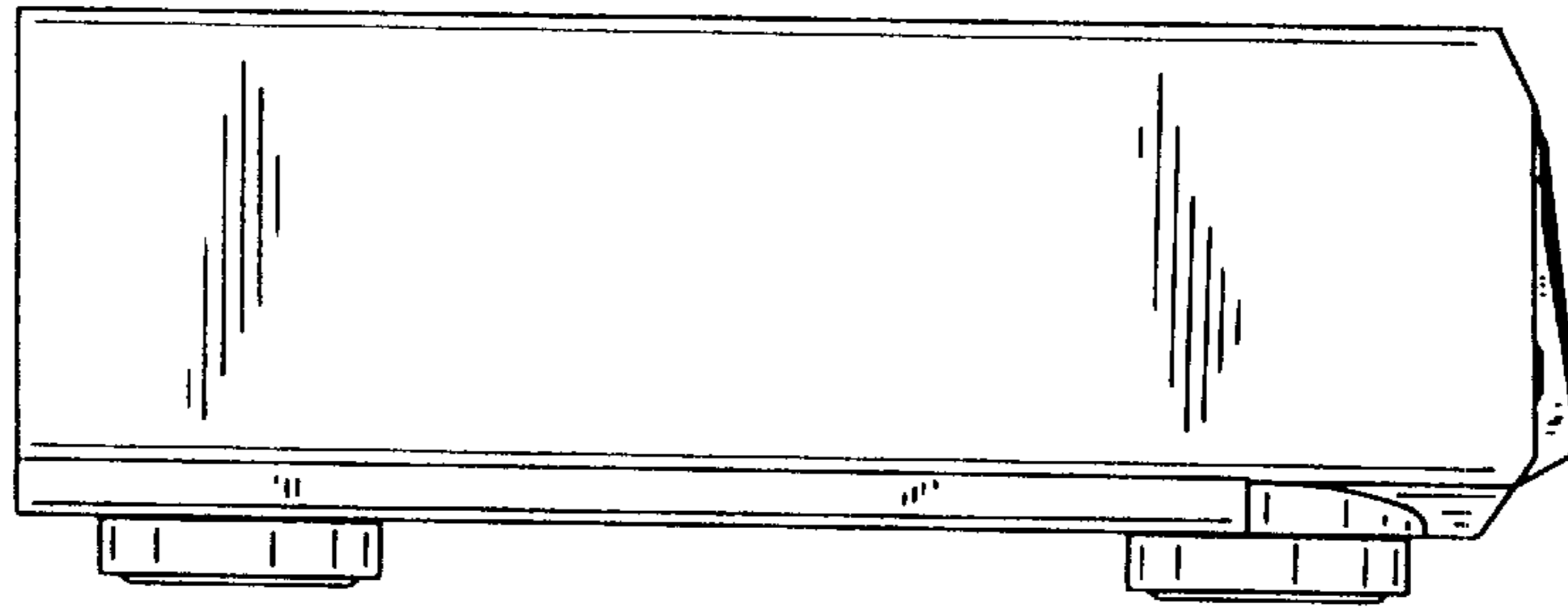

FIG. 7

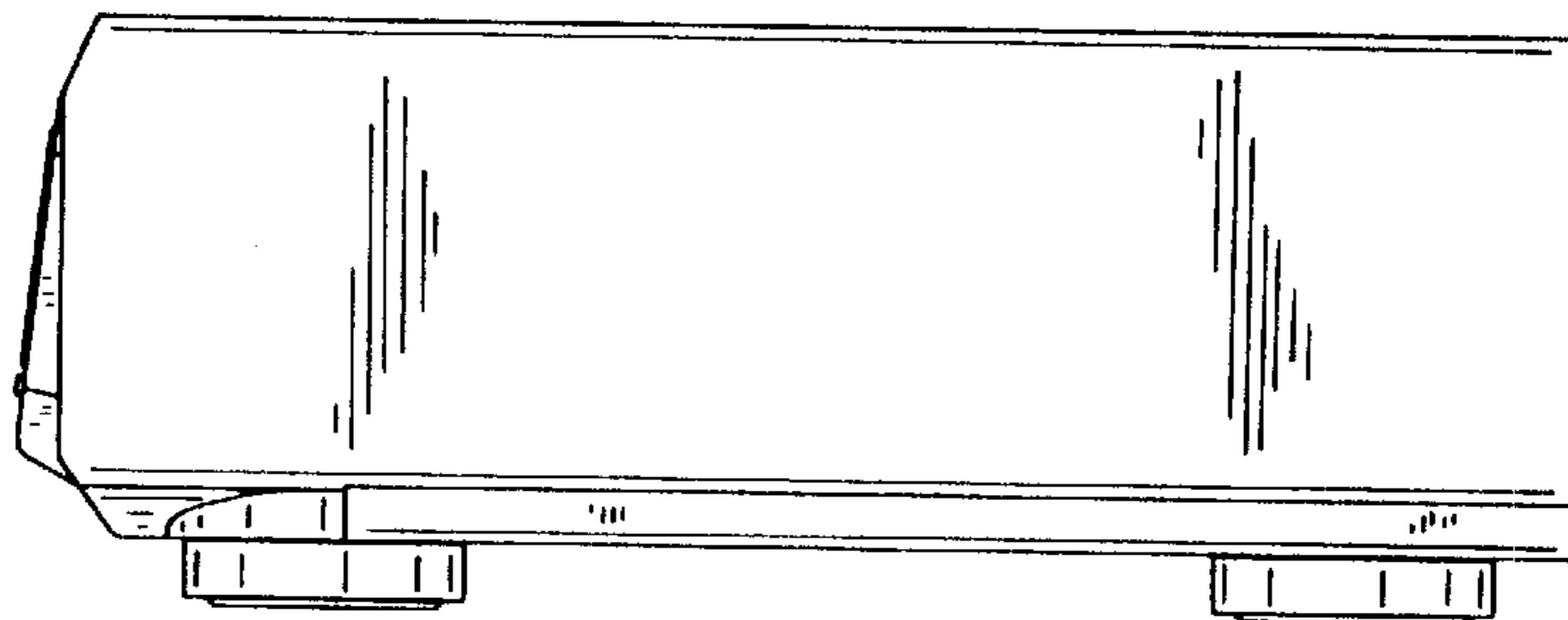

FIG. 4

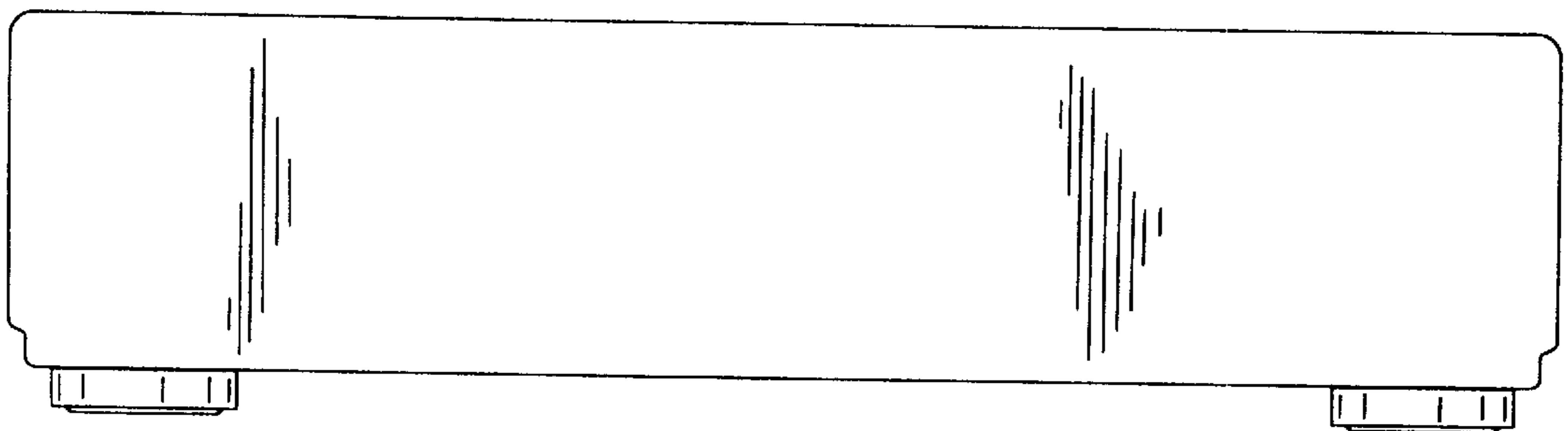

FIG. 5

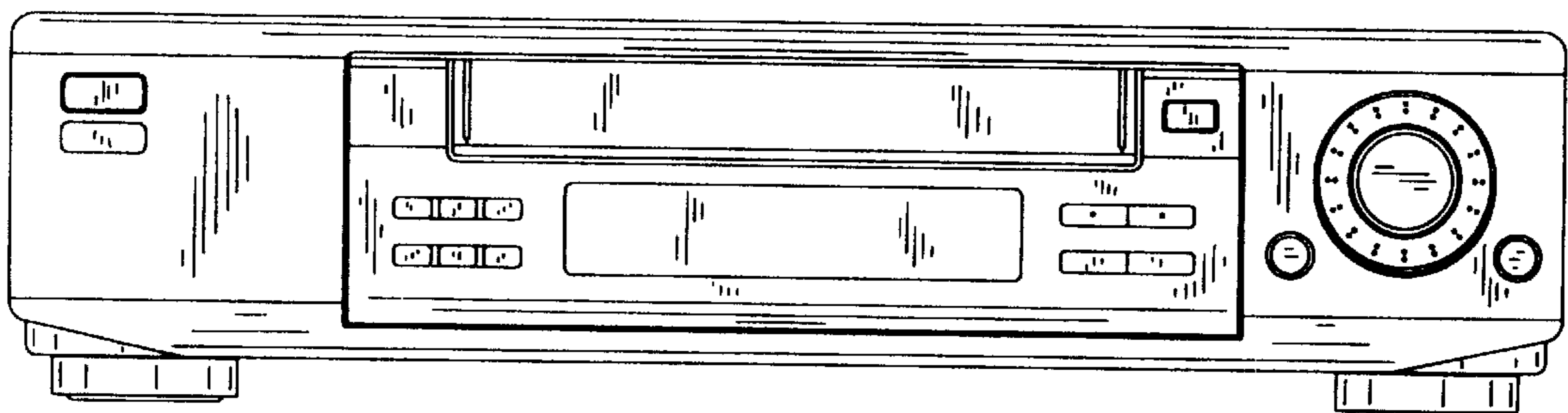

FIG. 8

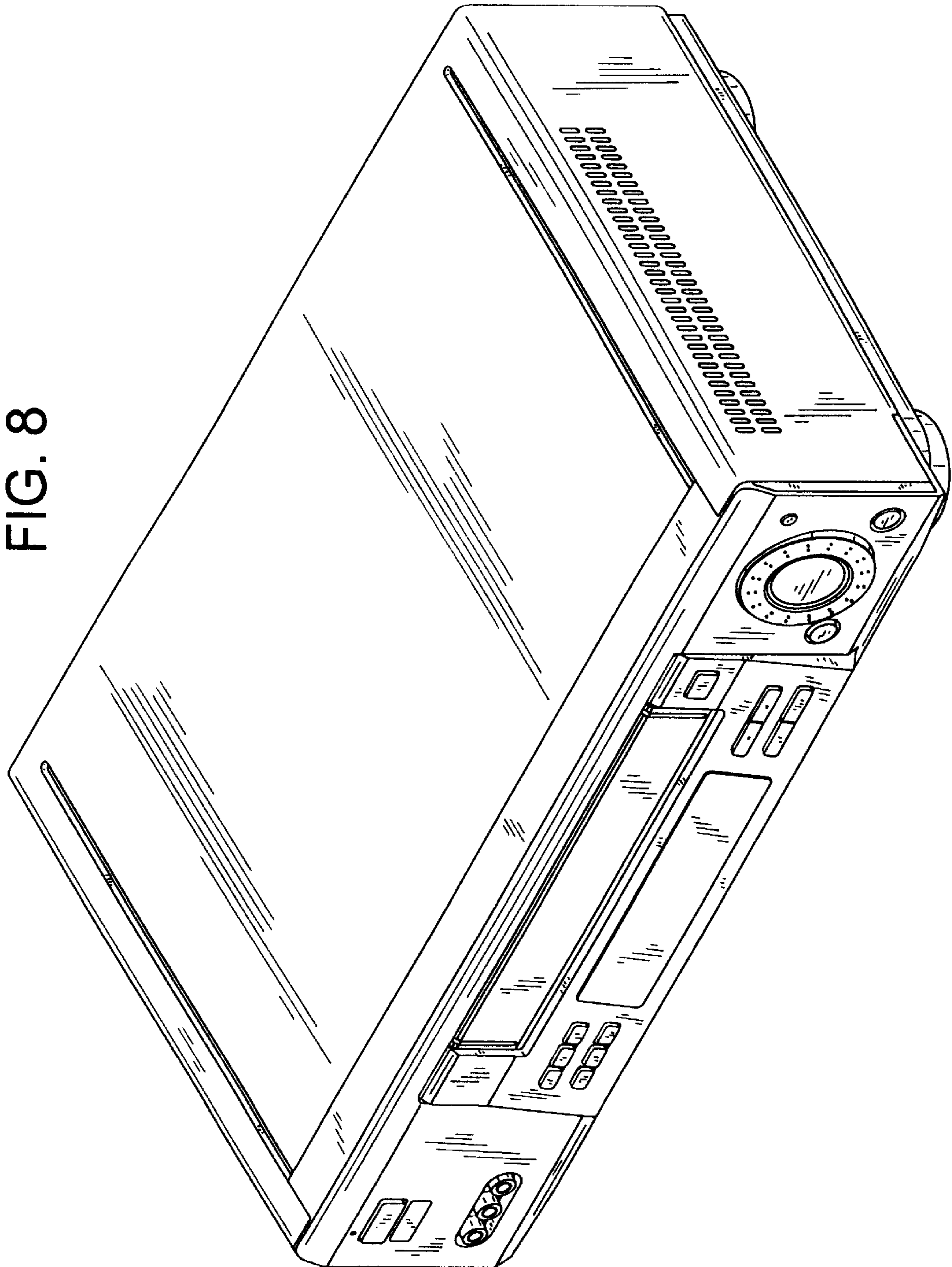

FIG. 9

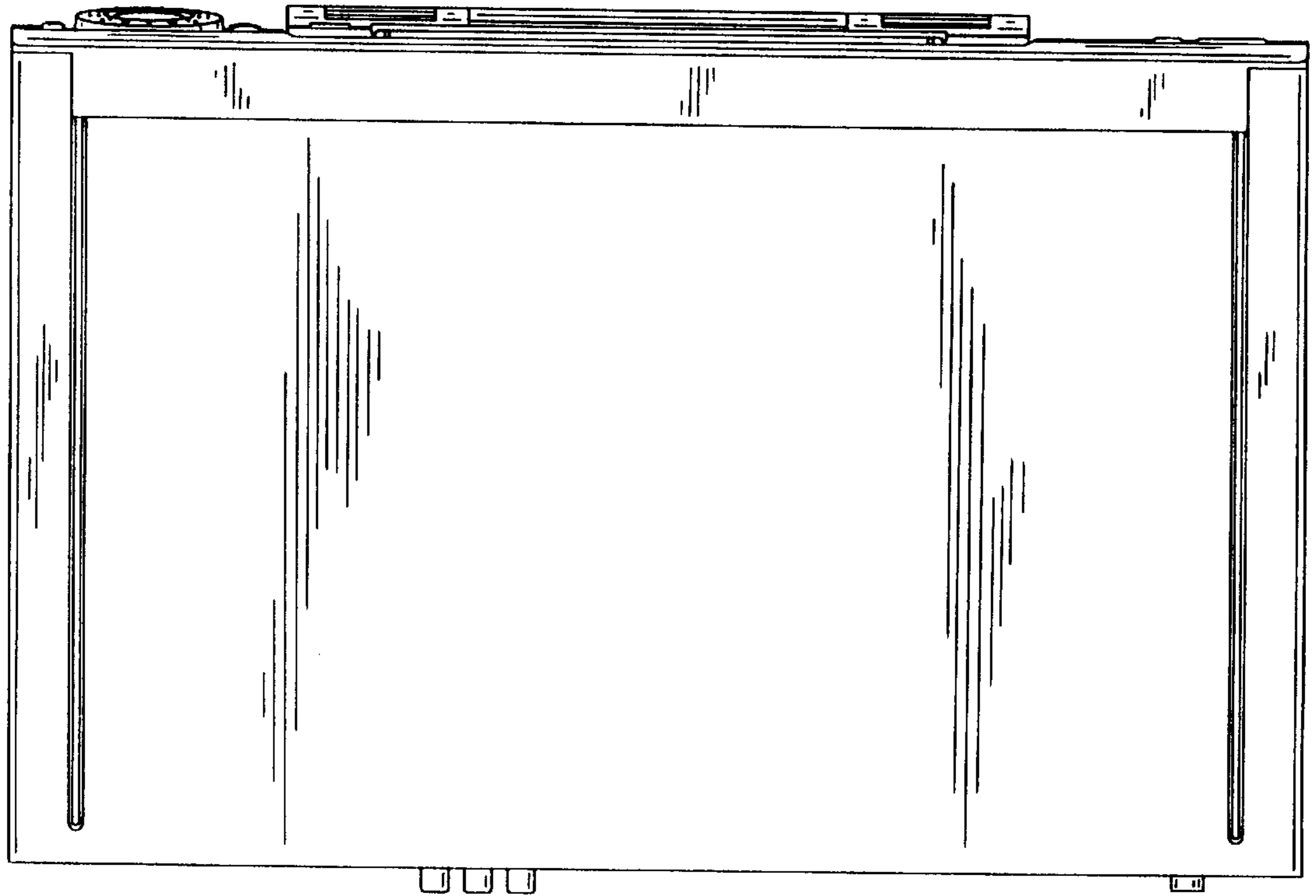

FIG. 13

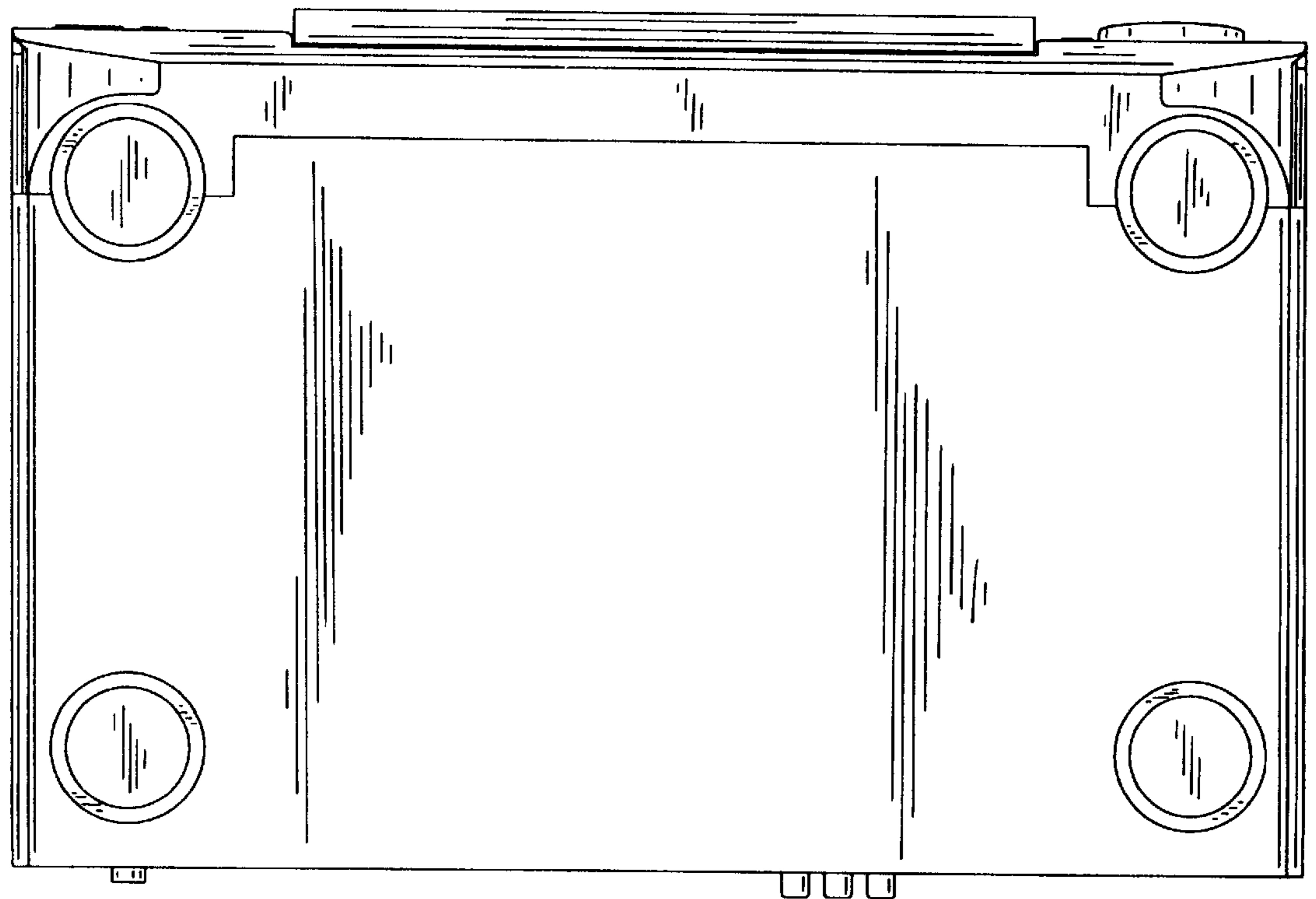

FIG. 10

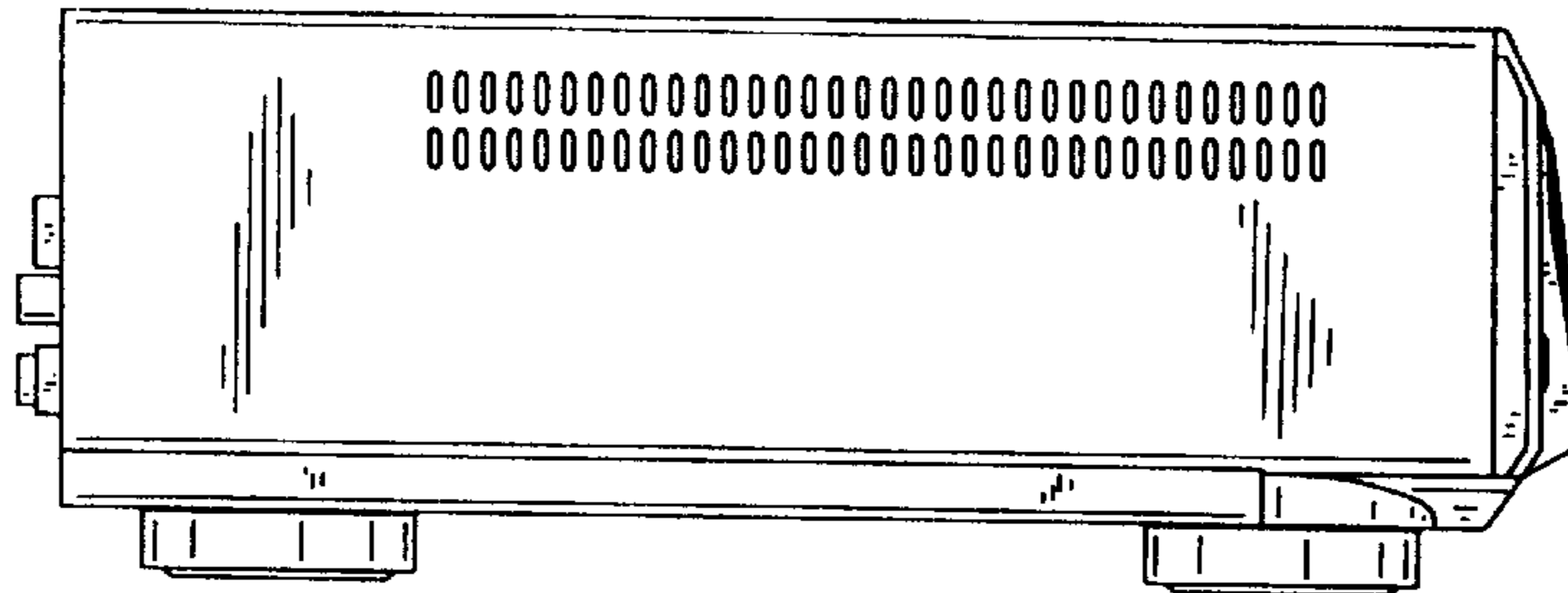

FIG. 14

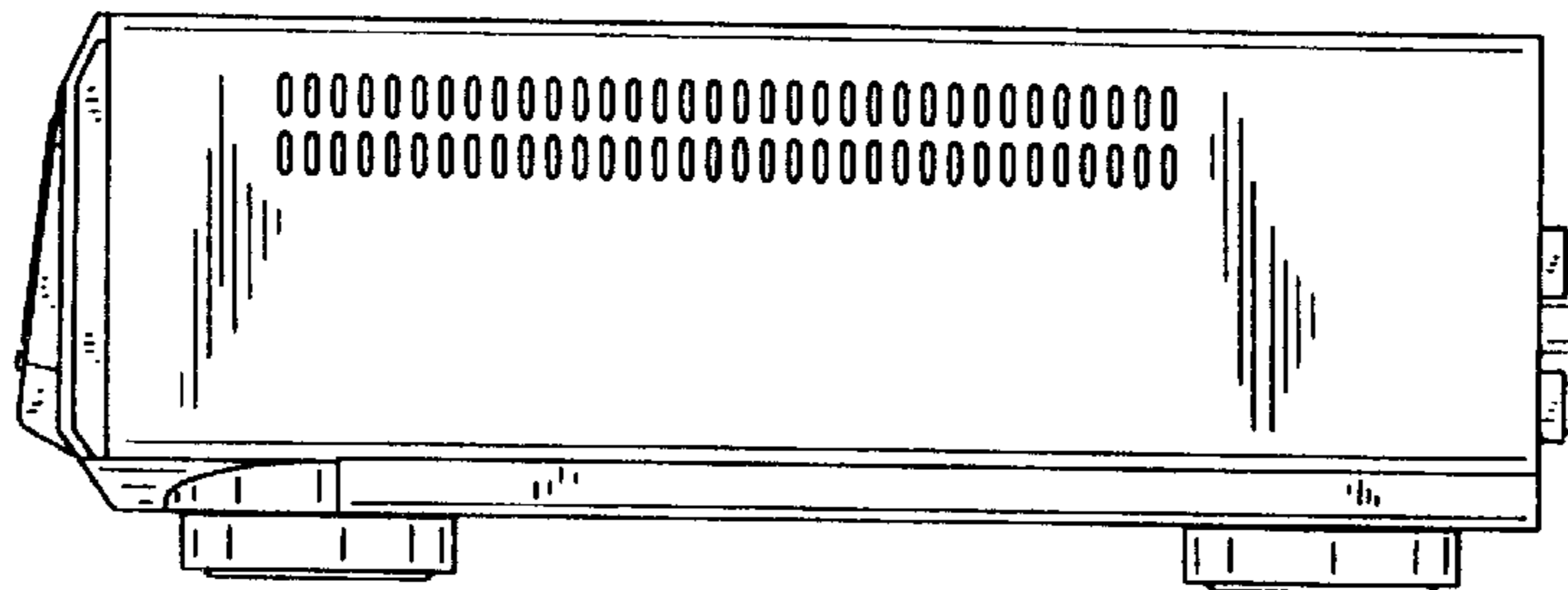

FIG. 11

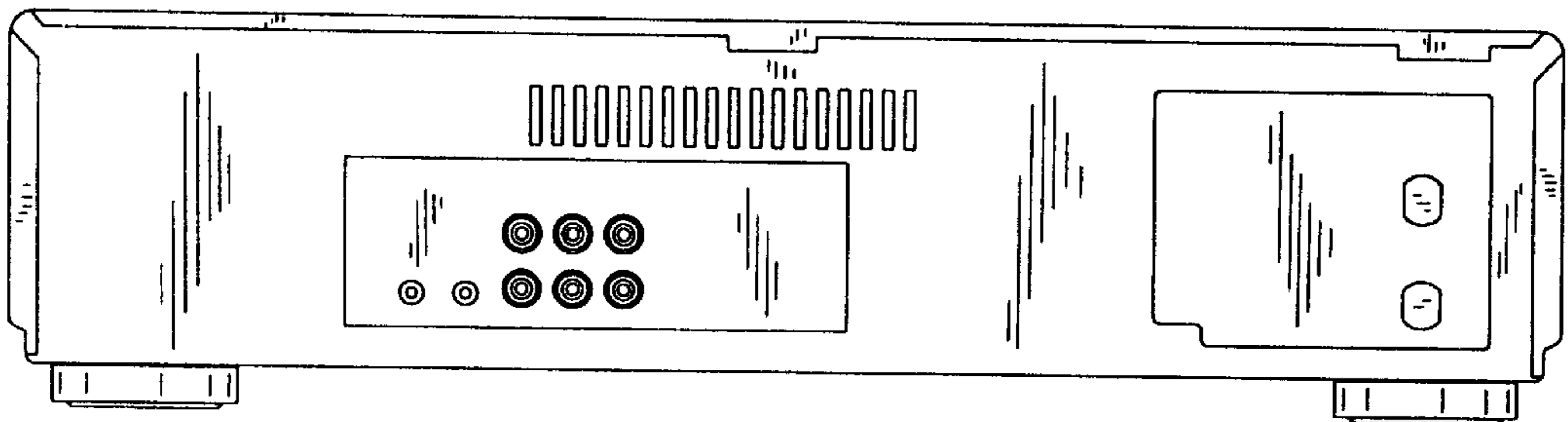

FIG. 12

