



US00D434955S

# United States Patent [19] Ronan

[11] **Patent Number: Des. 434,955**

[45] **Date of Patent: \*\* Dec. 12, 2000**

[54] **SHEARS**

4,578,864 4/1986 Hoffman ..... D8/98 X  
4,876,795 10/1989 Chun-Cheng ..... 30/287 X

[76] Inventor: **John S. Ronan**, 987 E. Commonwealth Ave., San Jacinto, Calif. 92583

[\*\*] Term: **14 Years**

[21] Appl. No.: **29/065,768**

[22] Filed: **Jun. 26, 1997**

### OTHER PUBLICATIONS

True Friends brochure, Mar. 31, 1986, cover page, pruning shears, item A located at top of page.  
Rainbird Catalog, 1986, p. 22, pruning shears, item PA-580 located at right of page.  
Advertisement—leaflet, Ronan's Trim Clipper Auto Trim News, p. 151, Sep.-Oct. 1989.  
Advertisement—leaflet, Ronan's Dynamic due, one page WCS Custom Tools, Jan. 1990 Printed in U.S.A.

### Related U.S. Application Data

[63] Continuation of application No. 29/011,425, Aug. 5, 1993, abandoned, which is a continuation-in-part of application No. 07/273,006, Nov. 18, 1988, Pat. No. Des. 387,965.

[51] **LOC (7) Cl. .... 08-01**

[52] **U.S. Cl. .... D8/5**

[58] **Field of Search .... D8/5, 4, 52, 98;  
30/251-252, 262, 287**

*Primary Examiner*—Holly Baynham  
*Attorney, Agent, or Firm*—Loyal McKinley Hanson

### [57] CLAIM

The ornamental design for shears, as shown and described.

### [56] References Cited

#### U.S. PATENT DOCUMENTS

D. 192,940 5/1962 Martin et al. .... D8/52  
D. 268,982 5/1983 Harrison et al. .... D8/52 X  
D. 307,699 5/1990 Suganami ..... D8/98 X  
D. 341,527 11/1993 Clivio ..... D8/5  
D. 342,652 12/1993 Wensley et al. .... D8/5  
3,336,666 8/1967 Calkin ..... D8/52 X  
3,733,627 5/1973 Epstein ..... D8/52  
3,874,578 4/1975 Derr et al. .... D8/52  
4,573,617 3/1986 Durkow ..... D8/98

### DESCRIPTION

FIG. 1 is a side elevational view of shears showing my new design.  
FIG. 2 is another side elevational view showing the side not shown in FIG. 1.  
FIG. 3 is a top plan view thereof.  
FIG. 4 is a bottom plan view thereof.  
FIG. 5 is a front elevational view thereof;  
FIG. 6 is a rear elevational view thereof, and;  
FIG. 7 is a perspective view thereof.

**1 Claim, 2 Drawing Sheets**

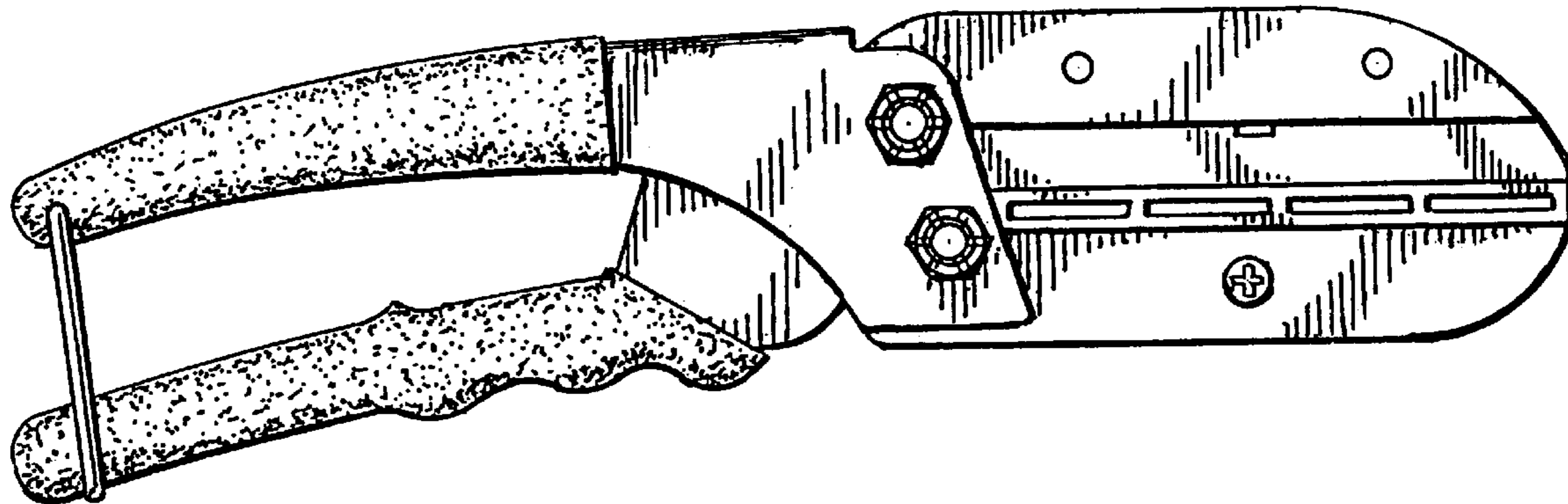

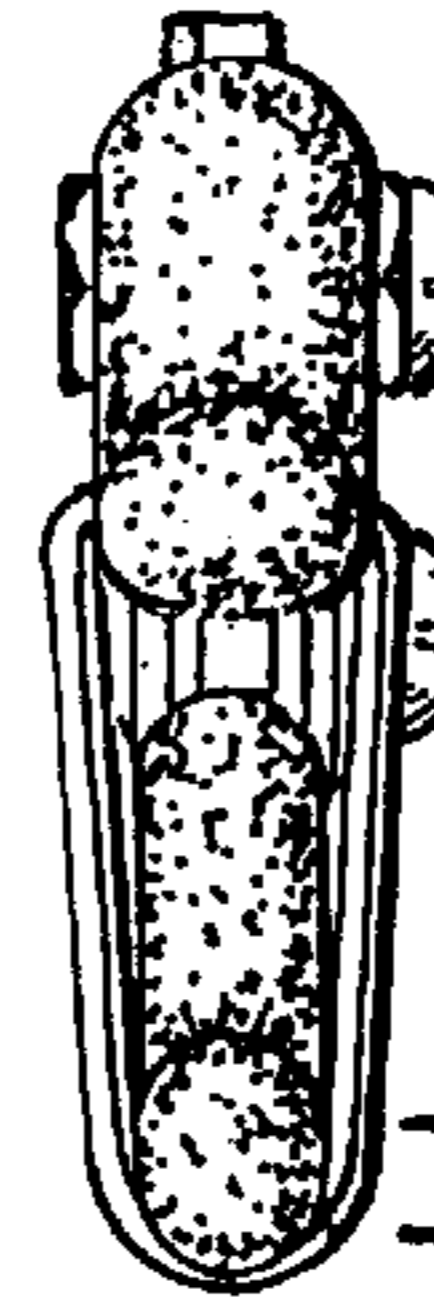
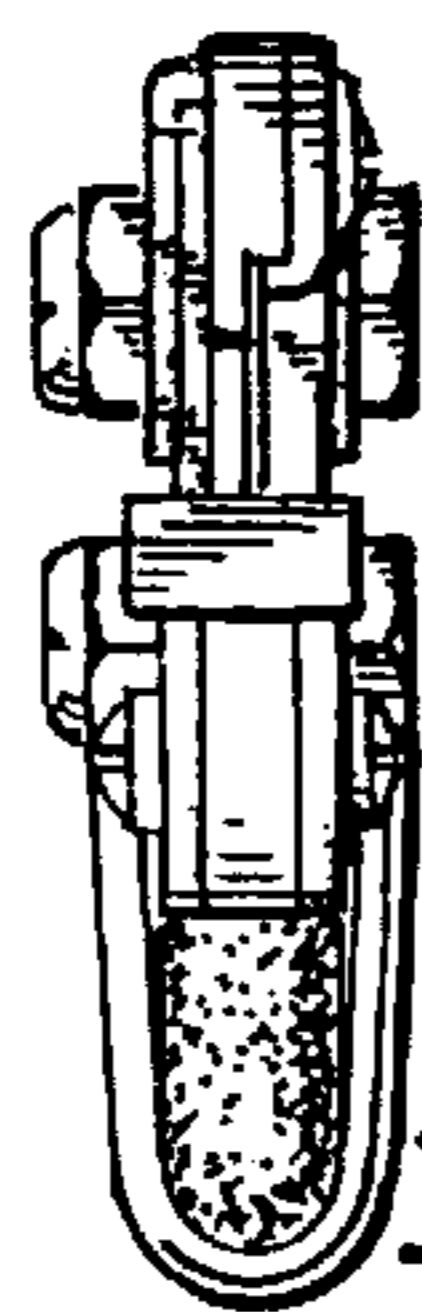
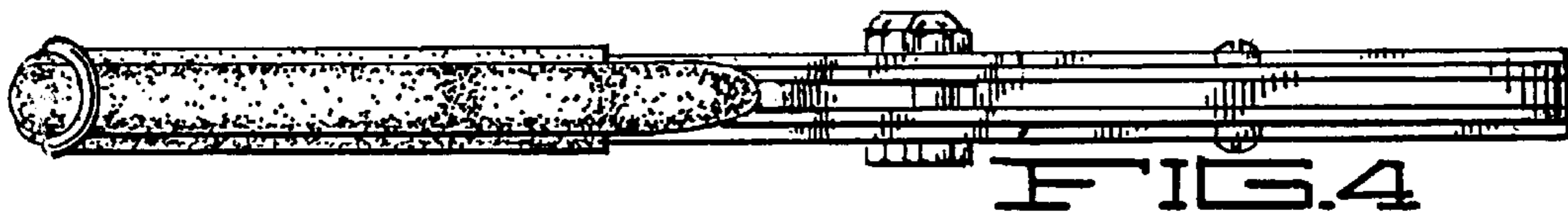
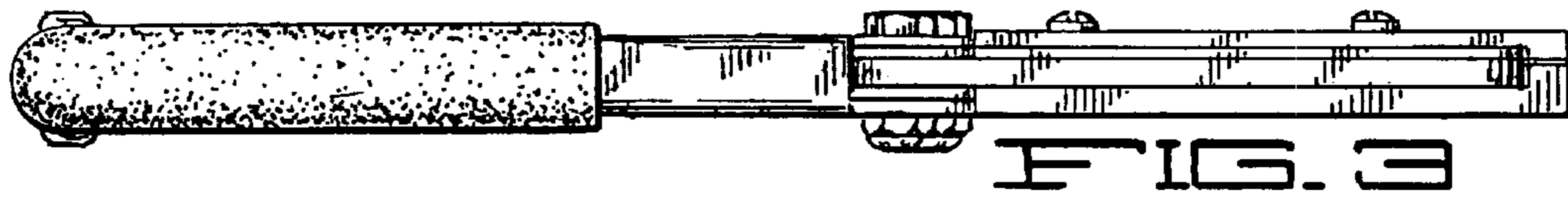
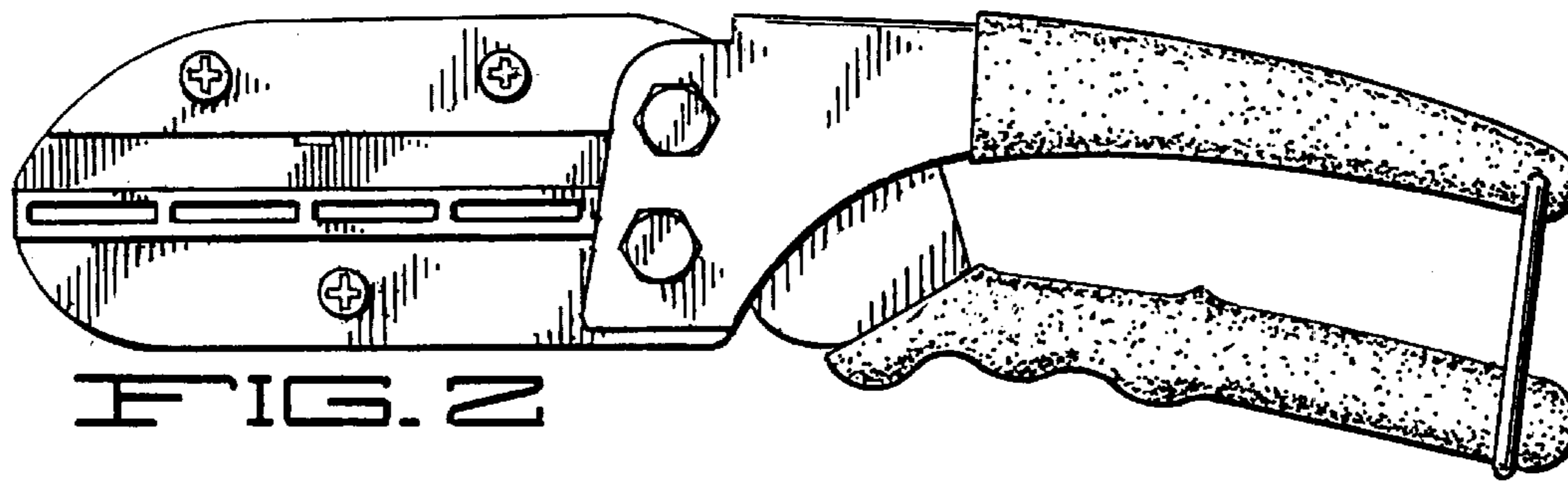
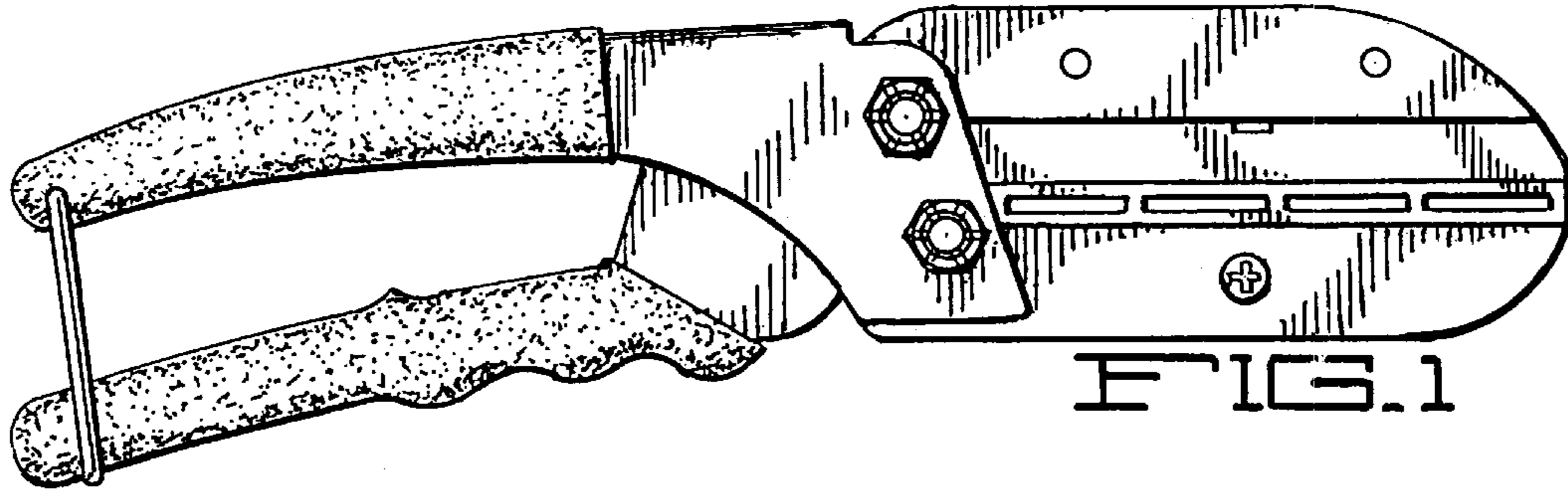

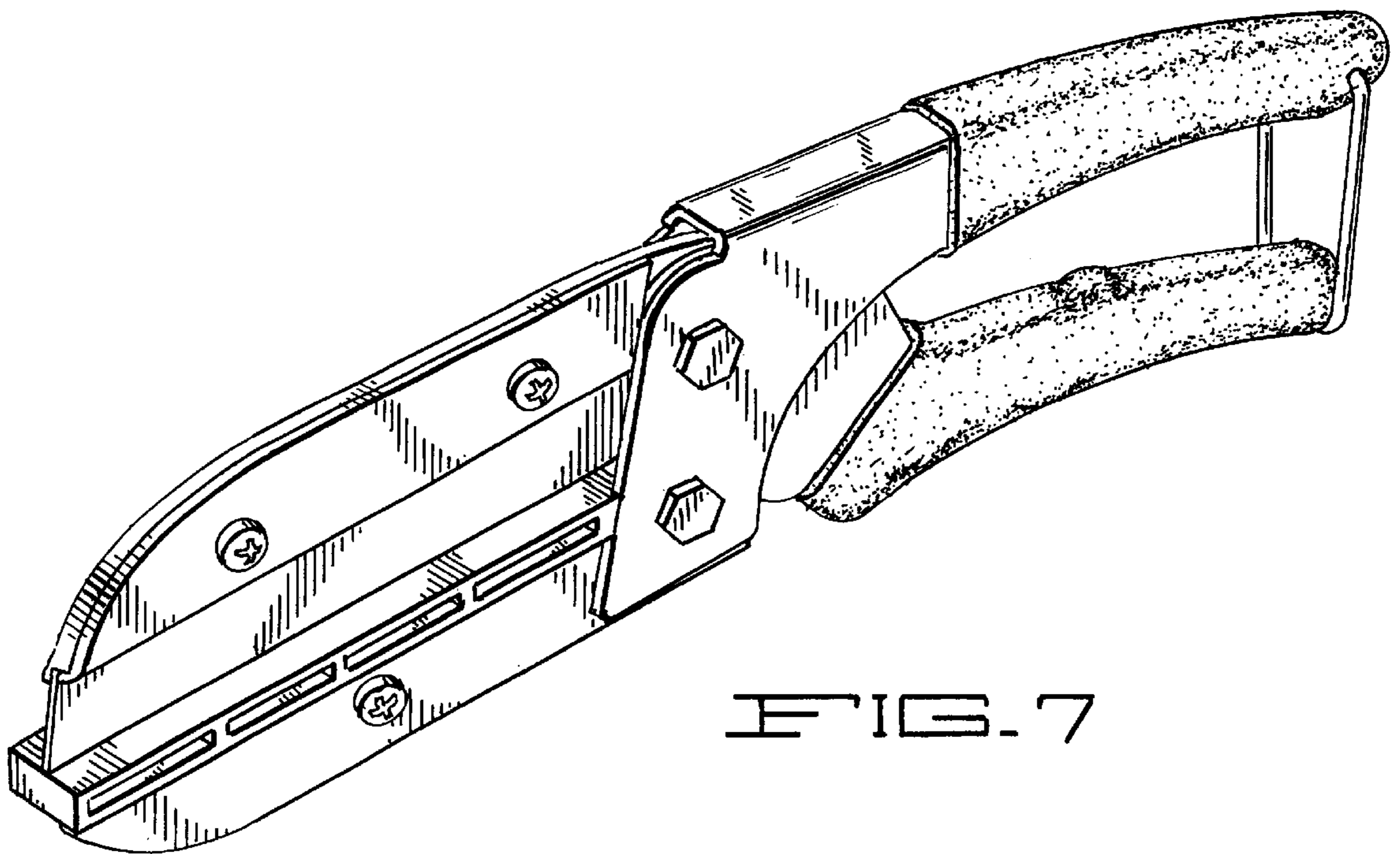

FIG. 7