

US00D434829S

**United States Patent** [19]  
**Ben-Tsur**

[11] **Patent Number: Des. 434,829**

[45] **Date of Patent: \*\* Dec. 5, 2000**

[54] **HAND HELD SHOWERHEAD**

[75] Inventor: **Gilad Ben-Tsur**, Gan-ner, Israel

[73] Assignee: **Masco Corporation of Indiana**, Indianapolis, Ind.

[\*\*] Term: **14 Years**

[21] Appl. No.: **29/118,731**

[22] Filed: **Feb. 14, 2000**

[51] **LOC (7) Cl.** ..... **23-01**

[52] **U.S. Cl.** ..... **D23/223**

[58] **Field of Search** ..... D23/213, 223,  
D23/226, 229; 239/394, 525-8, 462

[56] **References Cited**

**U.S. PATENT DOCUMENTS**

|            |        |          |       |         |
|------------|--------|----------|-------|---------|
| D. 224,834 | 9/1972 | Landell  | ..... | D23/223 |
| D. 295,437 | 4/1988 | Fabian   | ..... | D23/223 |
| D. 361,623 | 8/1995 | Huen     | ..... | D23/223 |
| D. 410,275 | 5/1999 | Lipshitz | ..... | D23/223 |

*Primary Examiner*—Robin V. Taylor  
*Attorney, Agent, or Firm*—Myron B. Kapustij; Lloyd D. Doigan

[57] **CLAIM**

The ornamental design for a hand held showerhead, as shown and described.

**DESCRIPTION**

FIG. 1 is a front perspective view of a hand held showerhead showing my new design;

FIG. 2 is a front elevational view thereof;

FIG. 3 is a top plan view thereof;

FIG. 4 is a left side elevational view thereof;

FIG. 5 is a bottom plan view thereof;

FIG. 6 is a right side elevational view thereof; and,

FIG. 7 is a rear elevational view thereof.

The broken line showing of the face plate in FIG. 1 is for purpose of illustration only and forms no part of the claimed design.

**1 Claim, 4 Drawing Sheets**

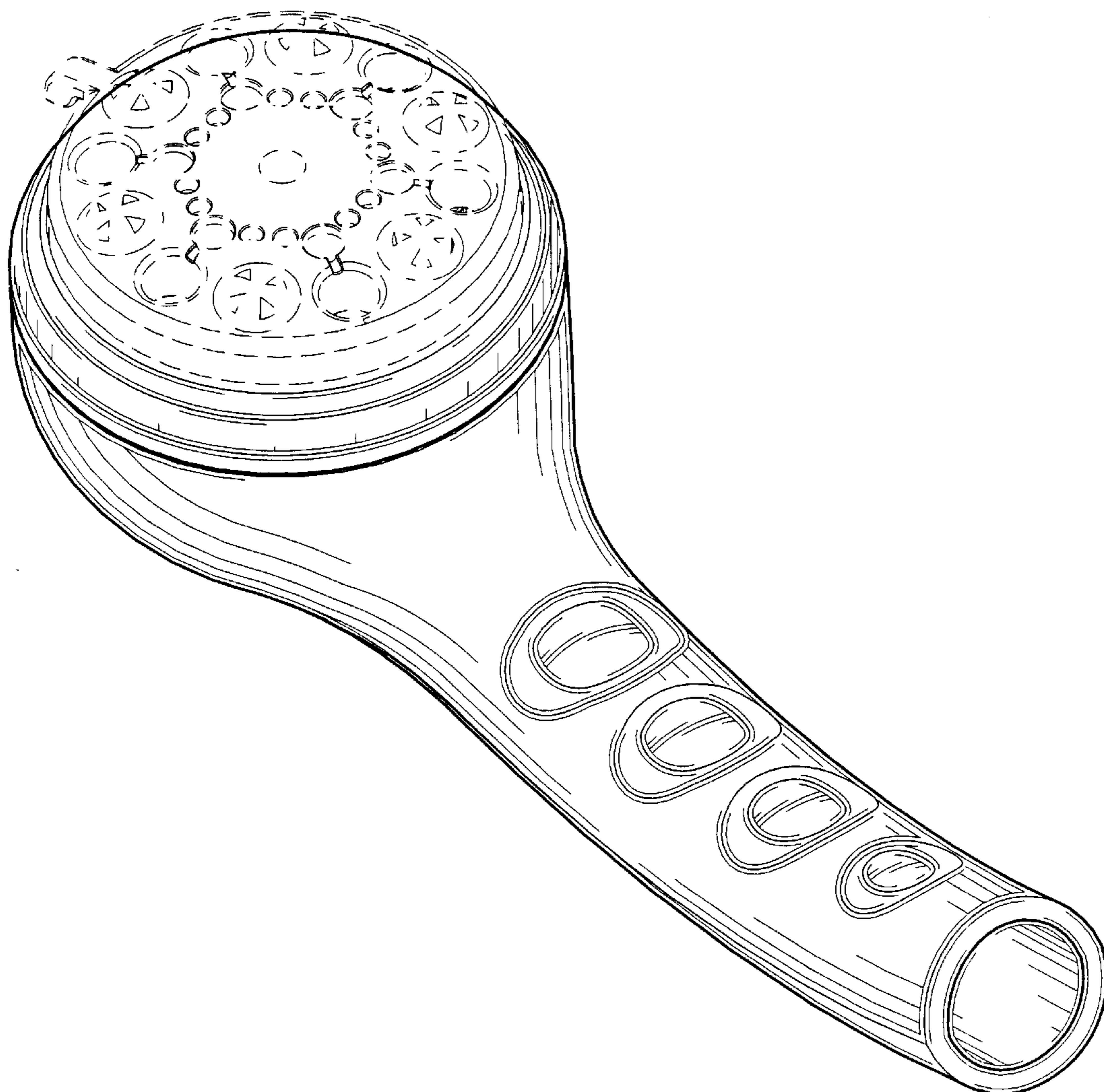

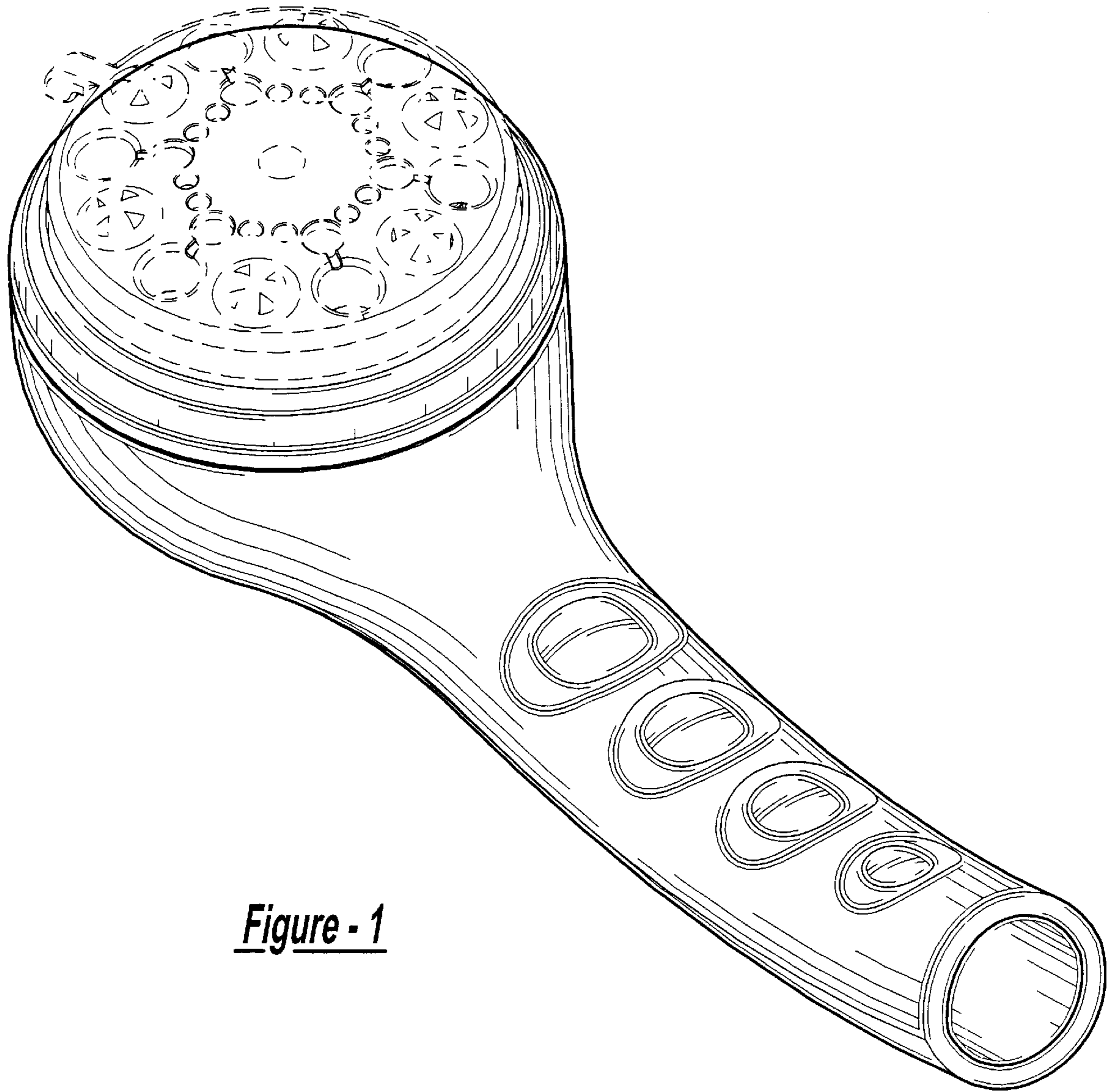

Figure - 1

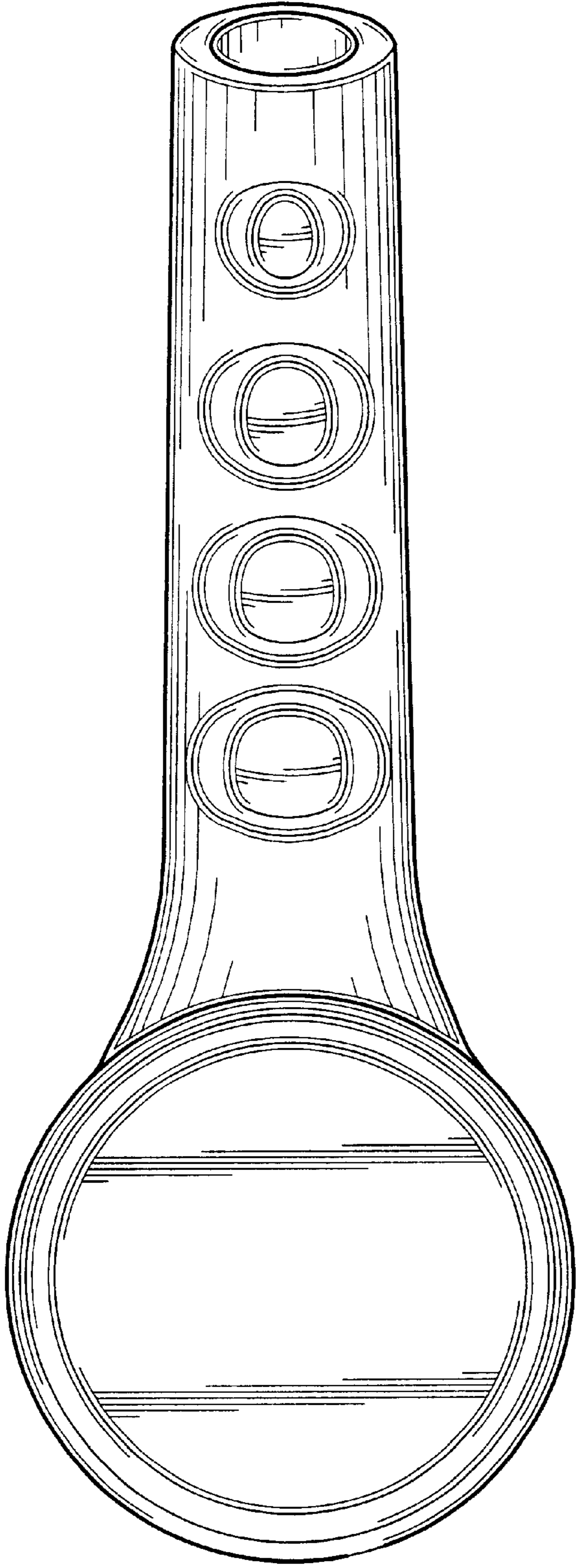

Figure - 2

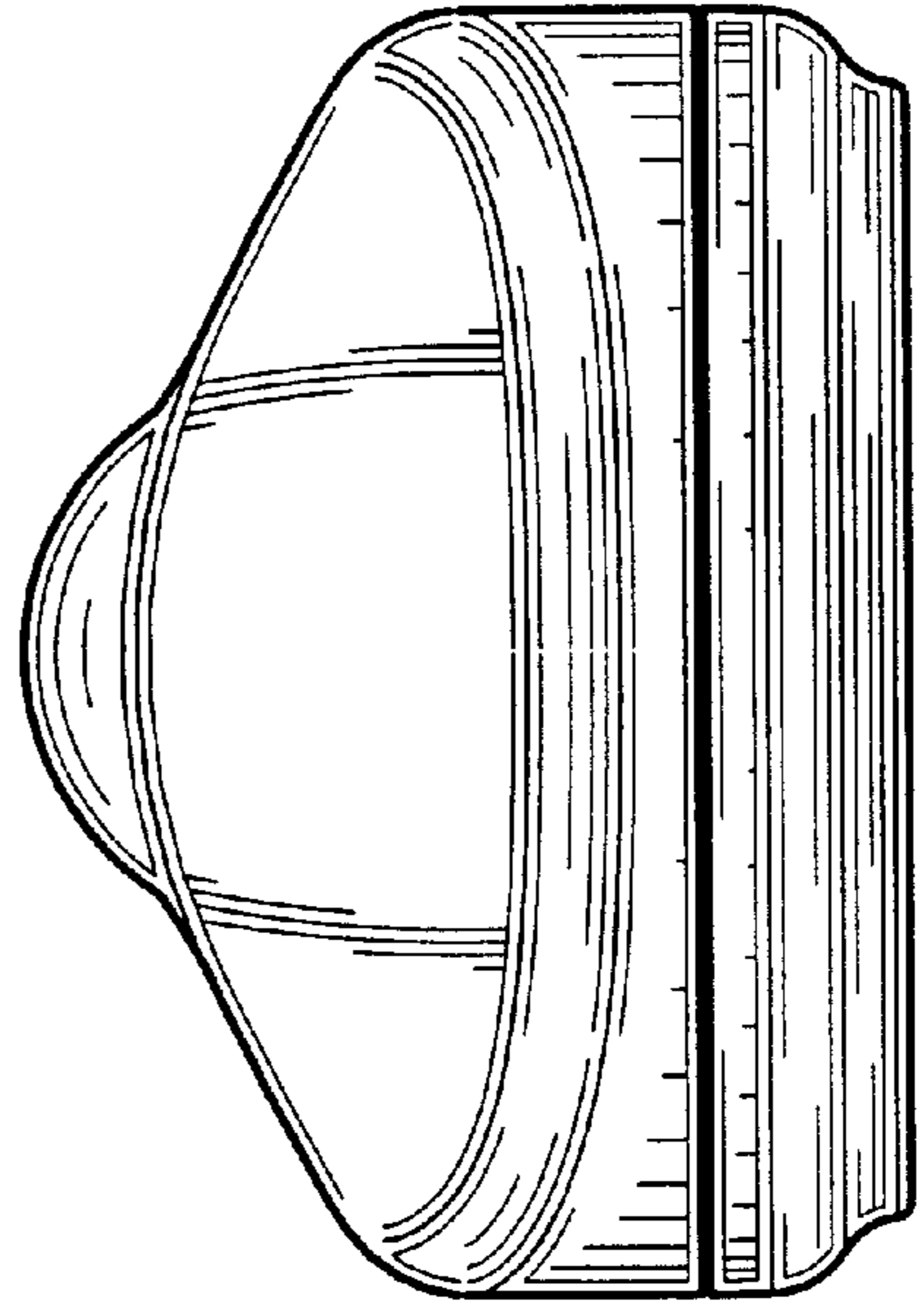

Figure - 3

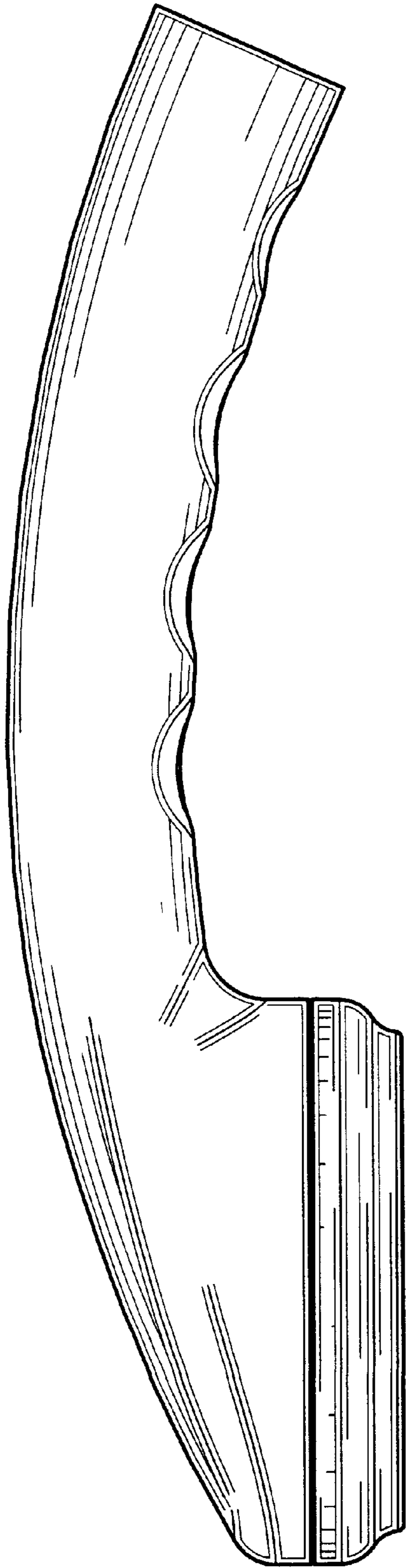

Figure - 4

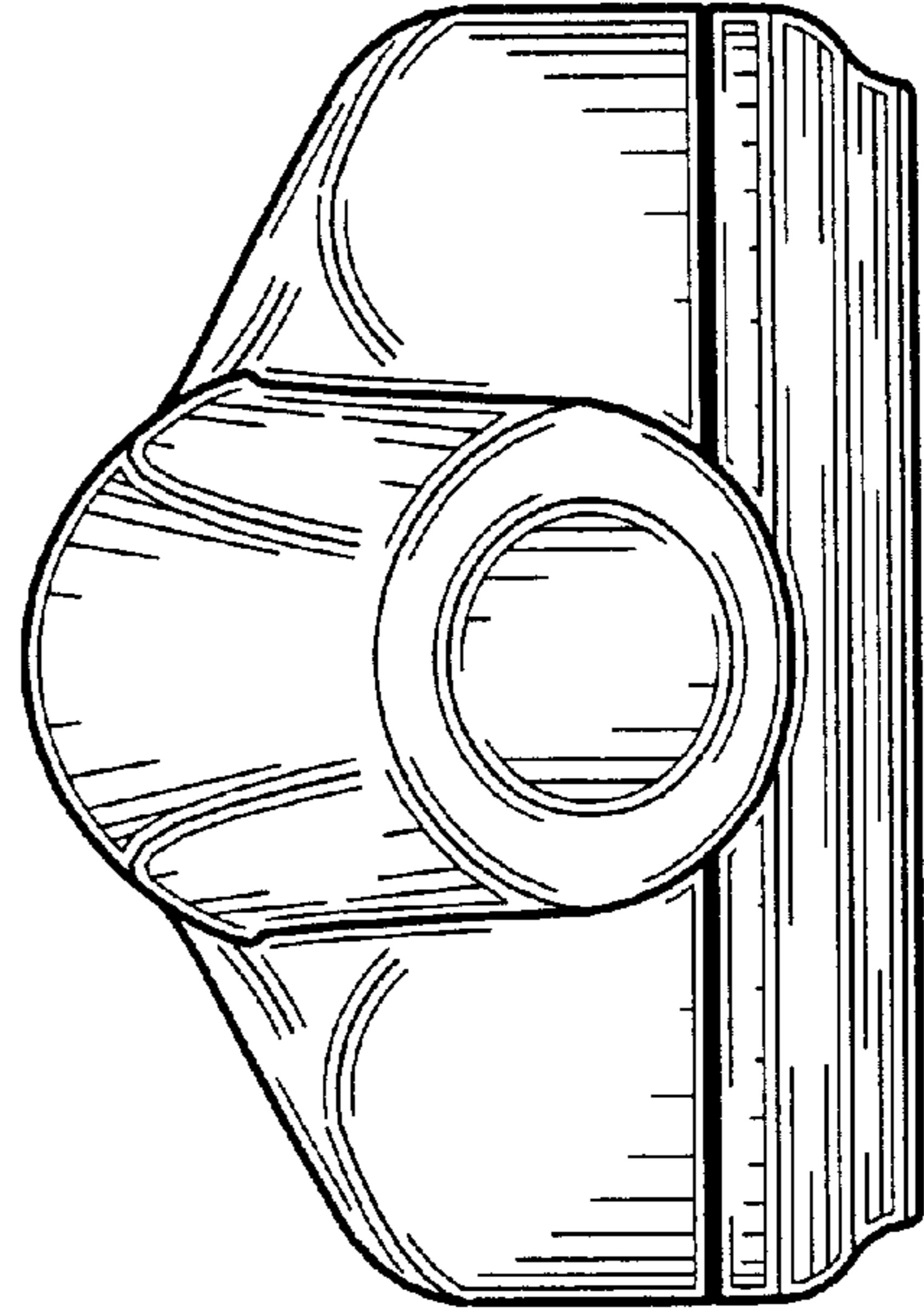

Figure - 5

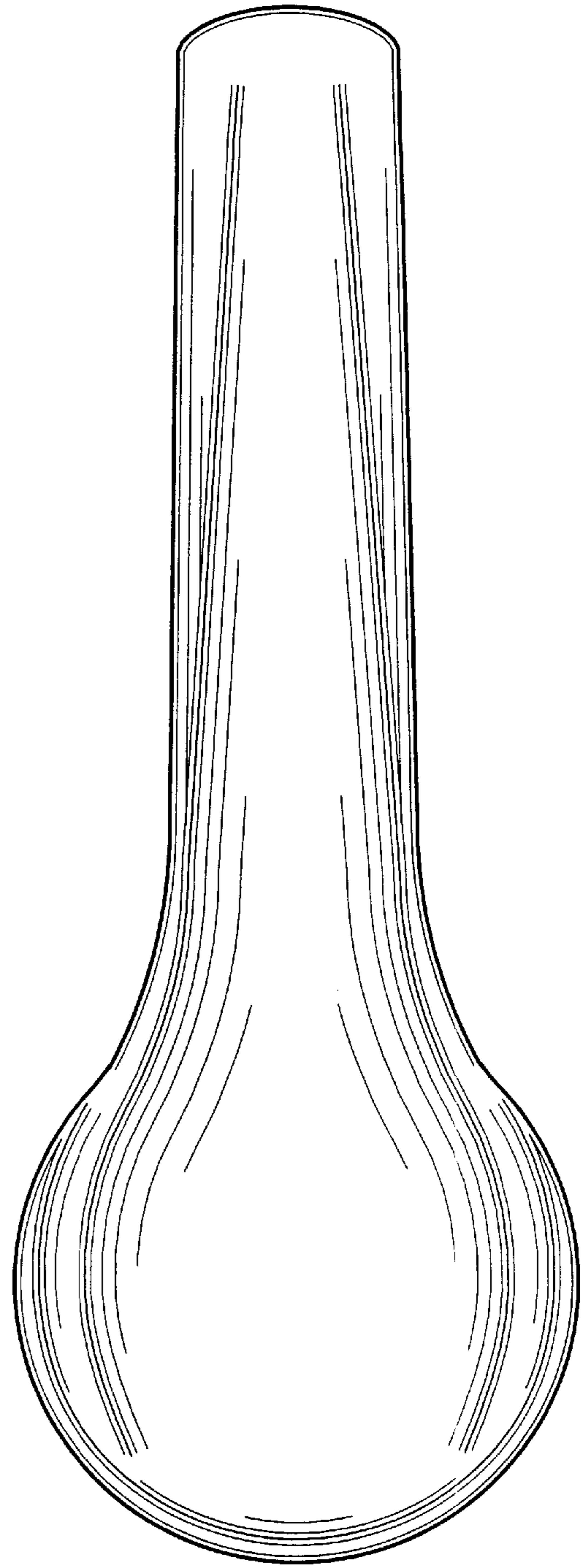
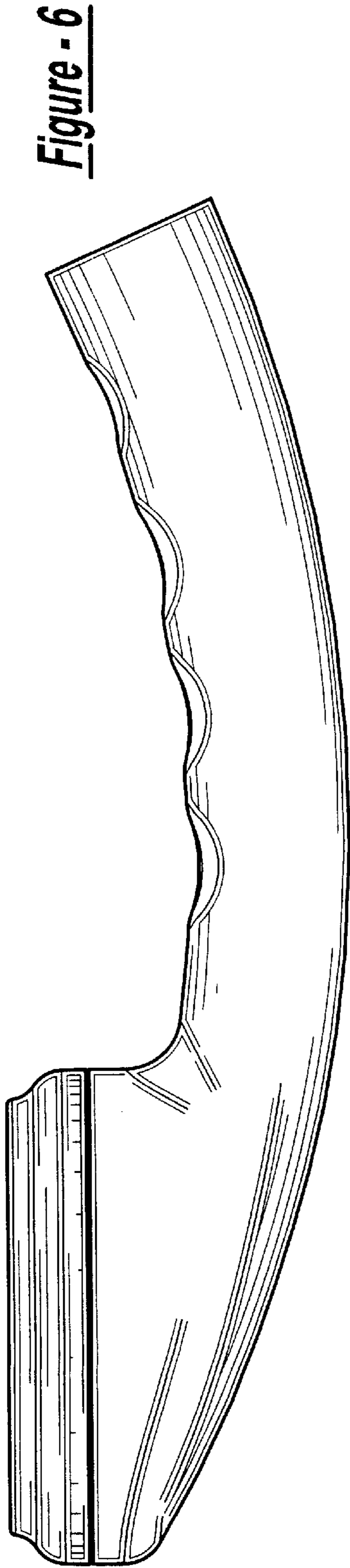

Figure - 7