



US00D434600S

United States Patent [19]

Garcia et al.

[11] Patent Number: **Des. 434,600**

[45] Date of Patent: **** Dec. 5, 2000**

[54] **COFFEE POT HOLDER**

D. 393,780 4/1998 Stocco D7/619
4,038,914 8/1977 Crespo et al. 99/279

[76] Inventors: **Pablo Garcia**, 210 NW. 87 Ave.,
L-224, Miami, Fla. 33172; **Mario R. Benitez**, 13717 SW. 154 St., Miami,
Fla. 33177

Primary Examiner—M. N. Pandozzi
Attorney, Agent, or Firm—J. Sanchelima

[**] Term: **14 Years**

[57] **CLAIM**

The ornamental design for coffee pot holder, as shown and described.

[21] Appl. No.: **29/113,185**

DESCRIPTION

[22] Filed: **Oct. 29, 1999**

[51] **LOC (7) Cl.** **07-99**

[52] **U.S. Cl.** **D7/397; D7/388**

[58] **Field of Search** D7/387, 397, 619,
D7/624, 388, 553.3, 553.2, 552.2, 305,
601, 311, 399; D6/406.5, 406.6, 484, 408;
99/279, 275, 306; 248/346.5

FIG. 1 is a top plan view of a coffee pot holder showing our new design;
FIG. 2 is a front elevational view thereof;
FIG. 3 is a bottom plan view thereof;
FIG. 4 is a left side elevational view thereof;
FIG. 5 is a back view thereof;
FIG. 6 is a right side elevational view thereof; and,
FIG. 7 is an isometric view of our design, showing the coffee pot in phantom.

[56] References Cited

U.S. PATENT DOCUMENTS

- D. 160,930 11/1950 Duff D6/484
- D. 256,757 9/1980 Stahel, II D7/624
- D. 275,926 10/1984 Corona D7/399
- D. 315,082 3/1991 Liberty, II D7/601

The broken line showing of a coffee pot in FIG. 7 is for illustrative purposes only and forms no part of the claimed design.

1 Claim, 3 Drawing Sheets

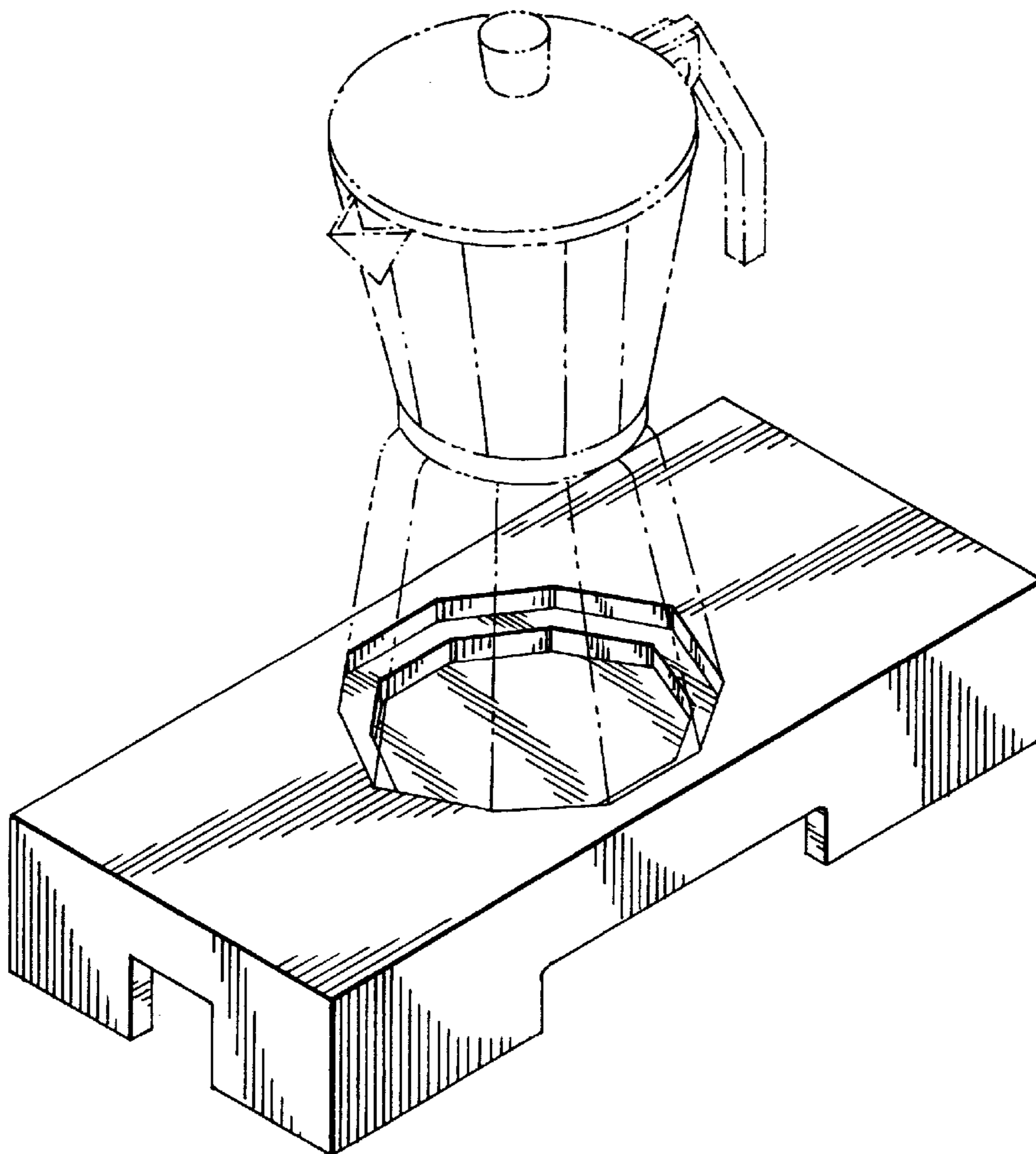

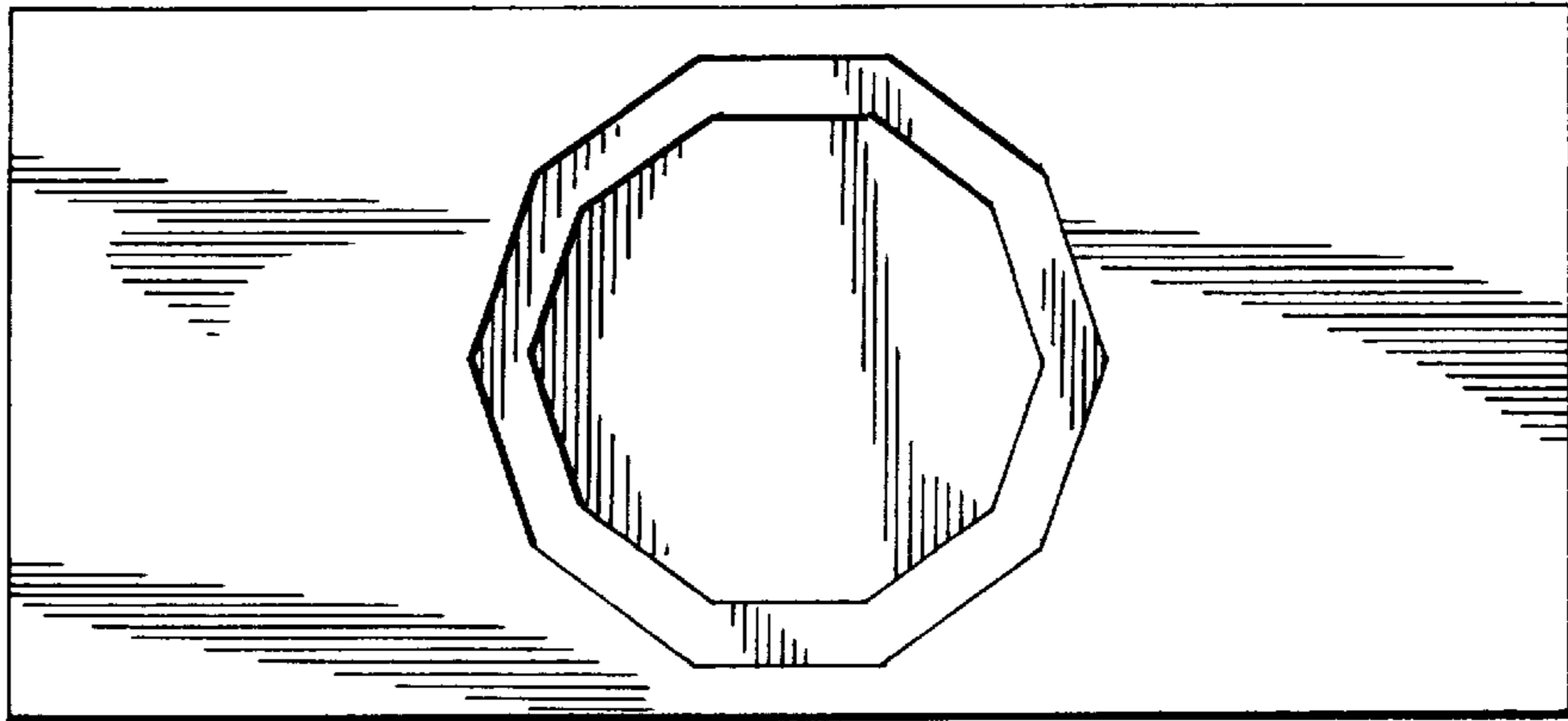

FIG. 1.

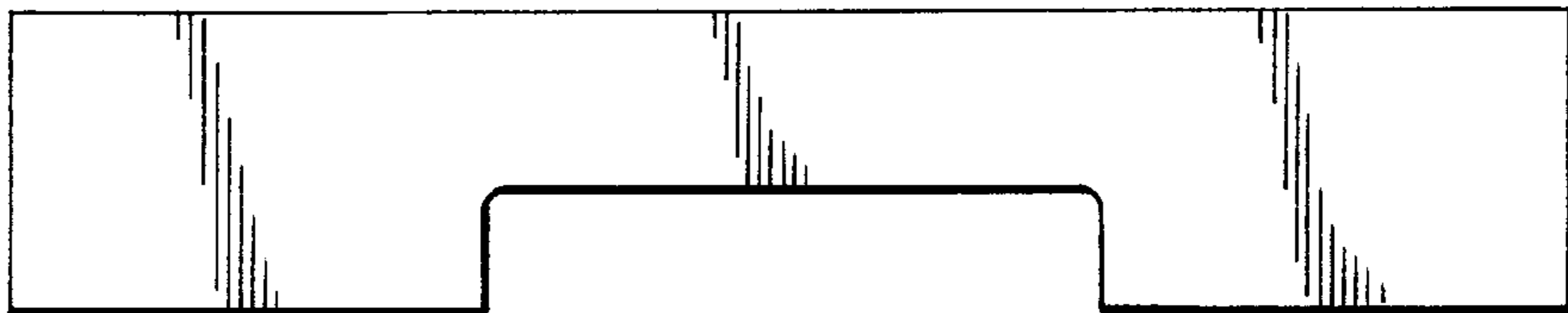

FIG. 2.

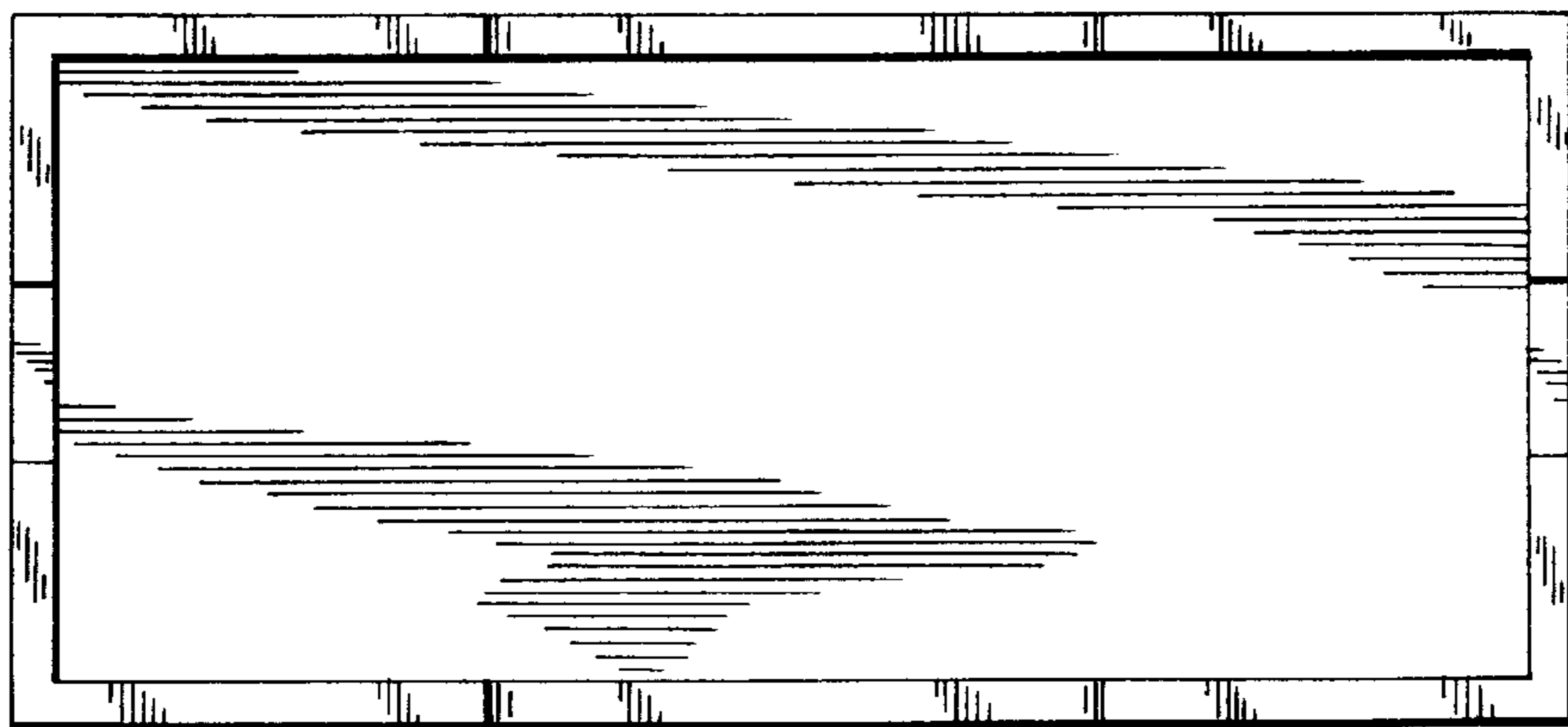

FIG. 3.

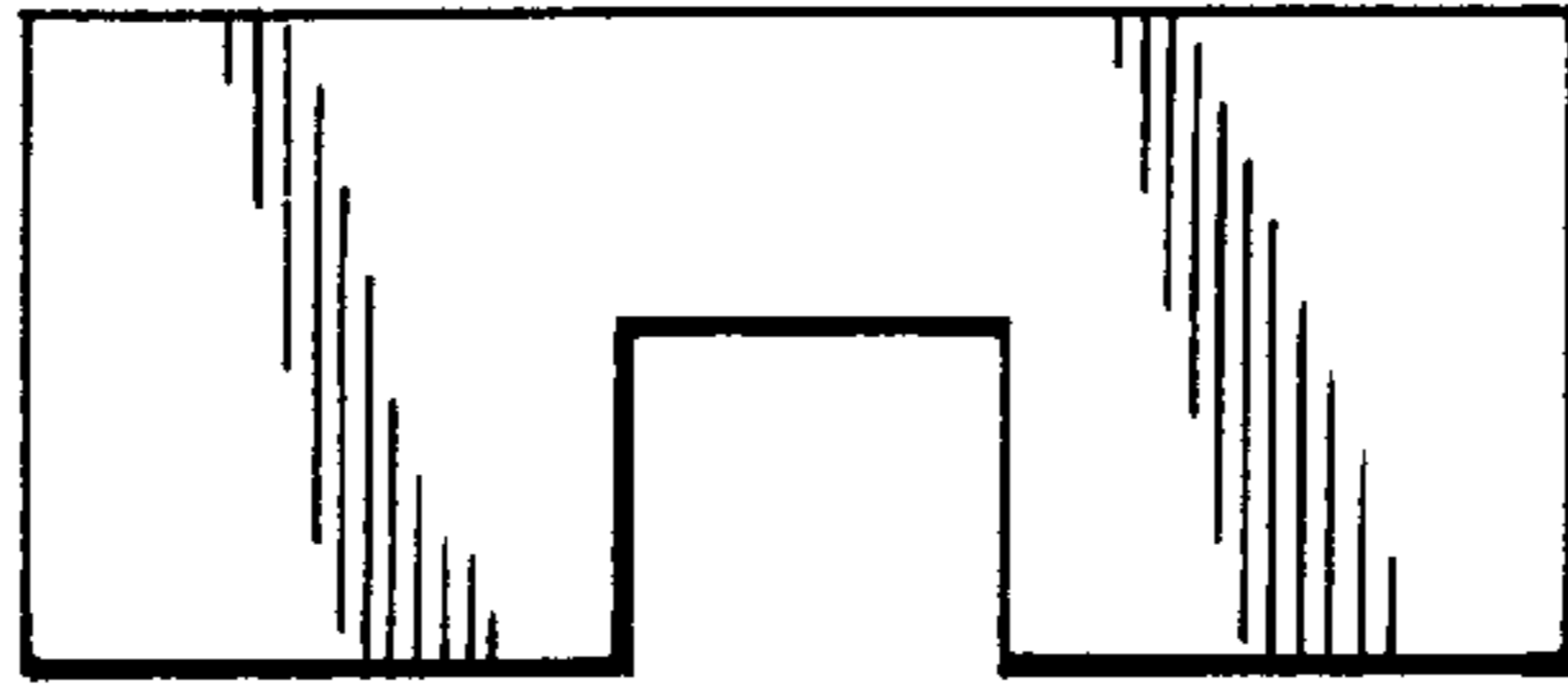

FIG. 4

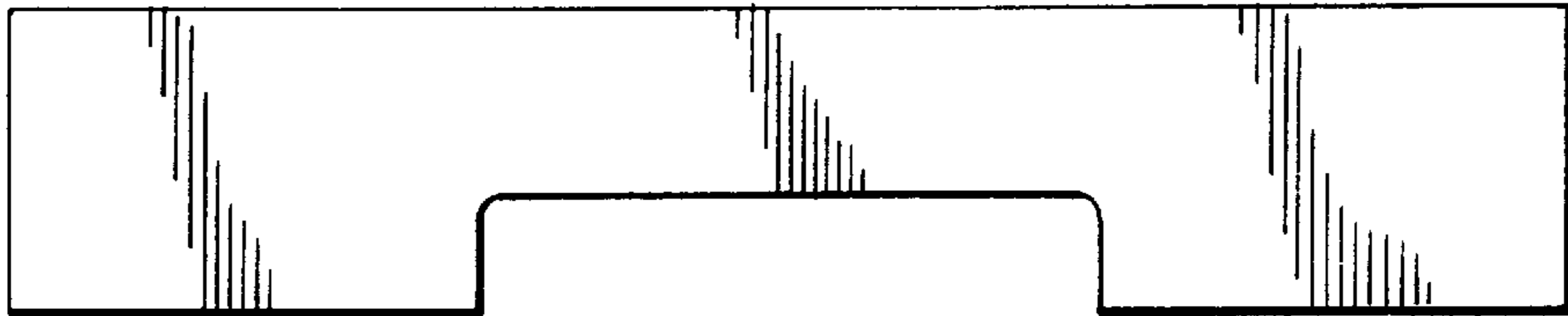

FIG. 5

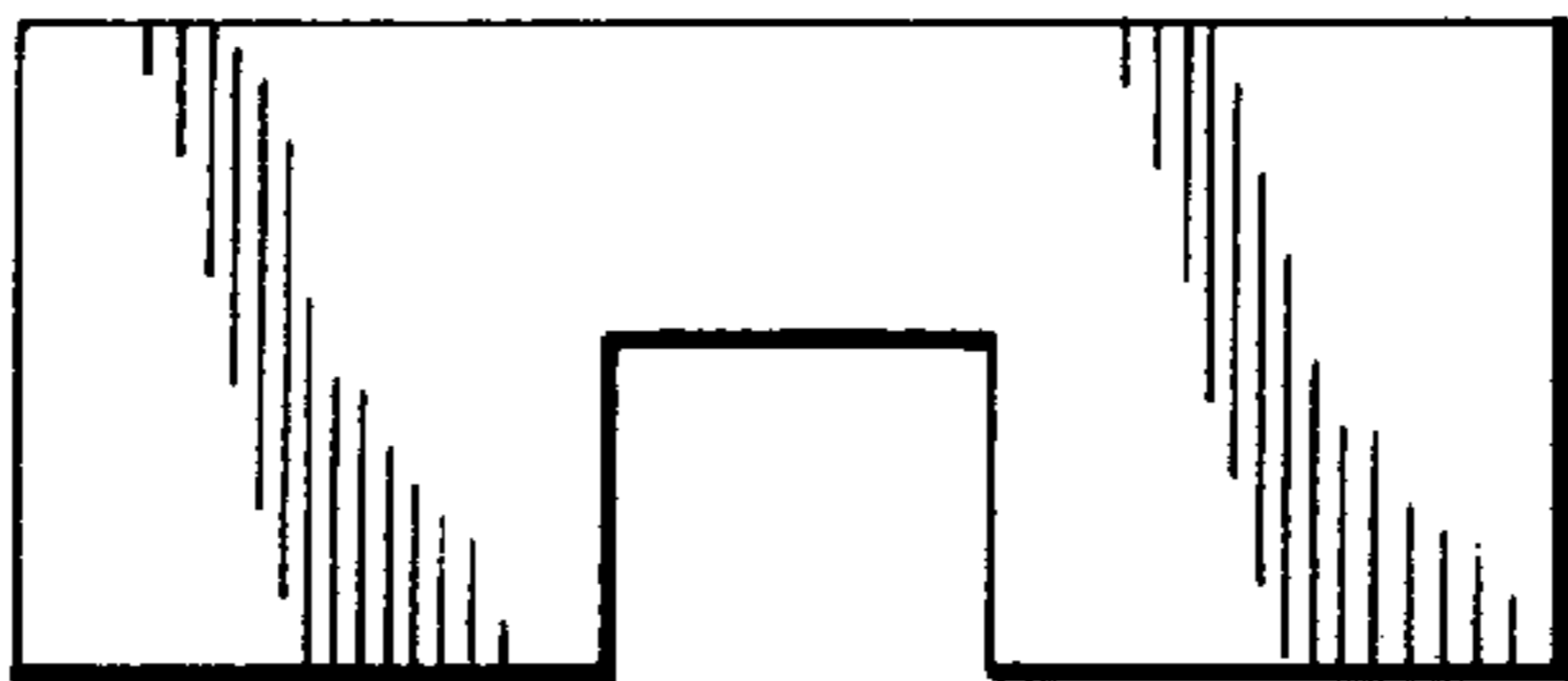

FIG. 6

