



US00D434530S

United States Patent [19] Rieser

[11] Patent Number: **Des. 434,530**

[45] Date of Patent: **** Nov. 28, 2000**

[54] **MANICURING TOOL**

264815 10/1912 Germany 30/28

[76] Inventor: **Udo Rieser**, Taunusring 28, 65205 Wiesbaden-Delkenheim, Germany

Primary Examiner—Catherine Tuttle
Attorney, Agent, or Firm—Milde, Hoffberg & Macklin, LLP

[**] Term: **14 Years**

[57] **CLAIM**

[21] Appl. No.: **29/085,056**

The ornamental design for a manicuring tool, as shown and described.

[22] Filed: **Mar. 16, 1998**

DESCRIPTION

[30] **Foreign Application Priority Data**

Sep. 19, 1997 [DE] Germany M 97 08 871
Nov. 5, 1997 [DE] Germany M 97 10 364

FIG. 1 is a top, right and rear perspective view of a manicuring tool according to a first embodiment of my design;

[51] **LOC (7) Cl.** **28-03**

FIG. 2 is a bottom, left and rear perspective view of the manicuring tool of FIG. 1;

[52] **U.S. Cl.** **D28/57**

[58] **Field of Search** D28/56, 57, 60;
D8/52-54, 58, 57, 5; 132/73, 75.4, 75.5;
30/26-29, 173, 175, 176, 134, 135, 186,
232, 234, 239, 252, 254, 261, 262, 266,
271

FIG. 3 is a top view of the manicuring tool of the FIGS. 1 and 2;

FIG. 4 is a right side view of the manicuring tool of the FIGS. 1 to 3;

FIG. 5 is a top, right and rear perspective view of the manicuring tool according to a second embodiment of my design;

[56] **References Cited**

U.S. PATENT DOCUMENTS

79,216 6/1868 Earle 7/134
D. 125,260 2/1941 Covey D8/5
D. 296,822 7/1988 Fenton D24/153
387,283 8/1888 Ducommun 30/254 X
1,727,760 9/1929 Forney et al. 30/254
2,146,132 2/1939 Scholl 30/28
2,239,314 4/1941 Connors 30/186
2,529,949 11/1950 Jones et al. 30/186
3,430,340 3/1969 Perles 30/28
3,772,783 11/1973 Averitt 30/186
3,833,953 9/1974 Fisher et al. 7/133
4,627,164 12/1986 Mikic et al. 30/135
5,522,290 6/1996 Visser et al. 81/427

FIG. 6 is a bottom, left and rear perspective view of FIG. 5;

FIG. 7 is a top view of the manicuring tool of the FIGS. 5 and 6;

FIG. 8 is a right side view of the manicuring tool of the FIGS. 5 to 7;

FIG. 9 is a top view of the manicuring tool according to a third embodiment of my design;

FIG. 10 is a right side view of the manicuring tool of FIG. 9;

FIG. 11 is a rear end view of FIGS. 1-4; and,
FIG.12 is a rear end view of FIGS. 5-8.

The surface(s) or portion(s) of the article not known in the drawing or described in the specification form(s) no part of the claimed design.

FOREIGN PATENT DOCUMENTS

711687 9/1931 France 132/75.5

1 Claim, 8 Drawing Sheets

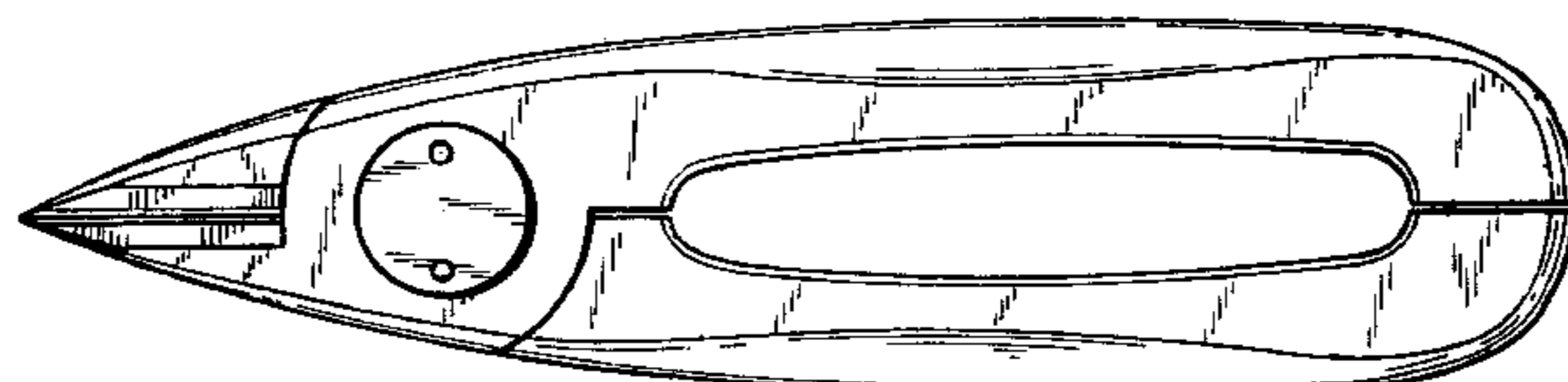
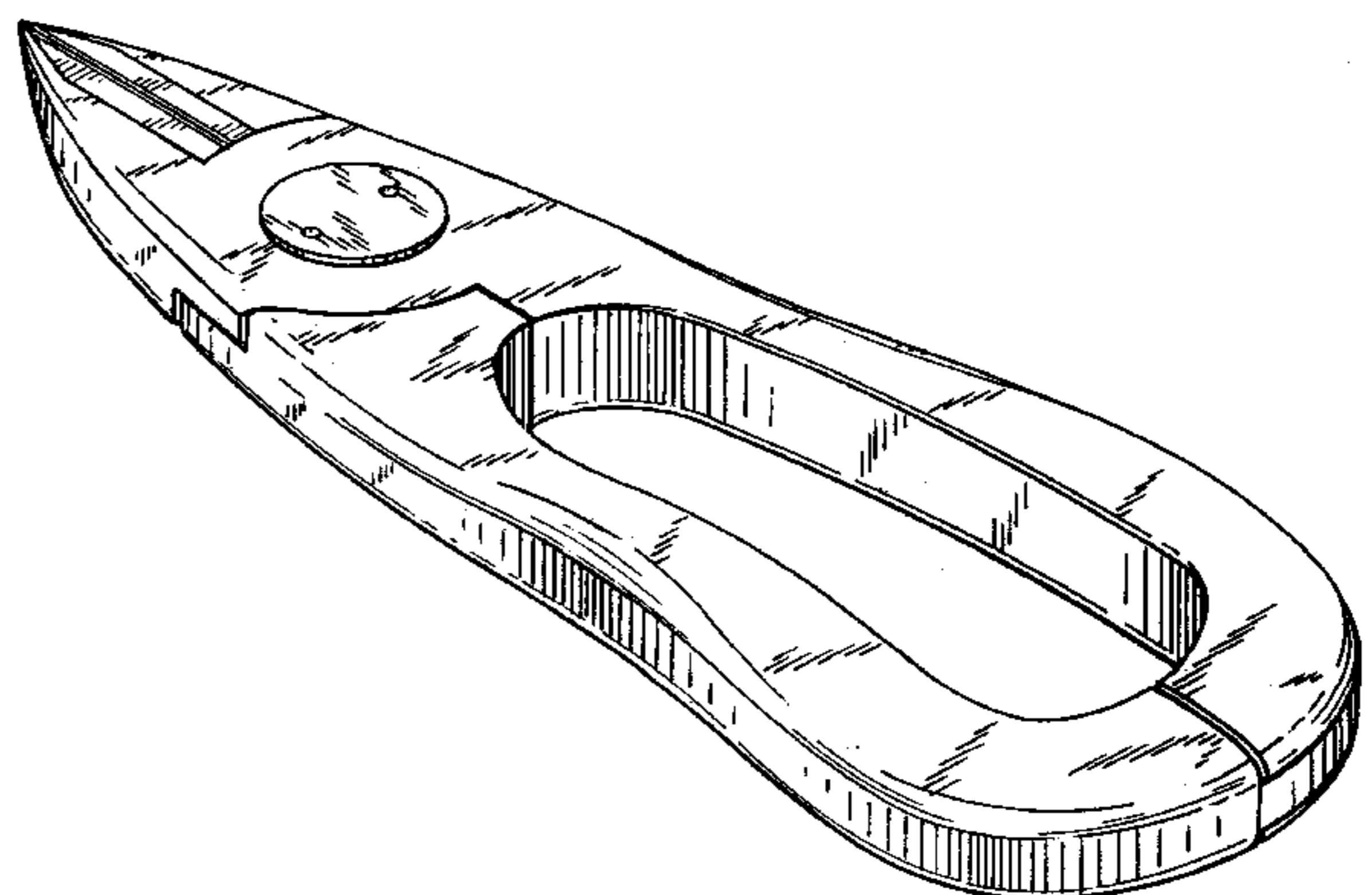
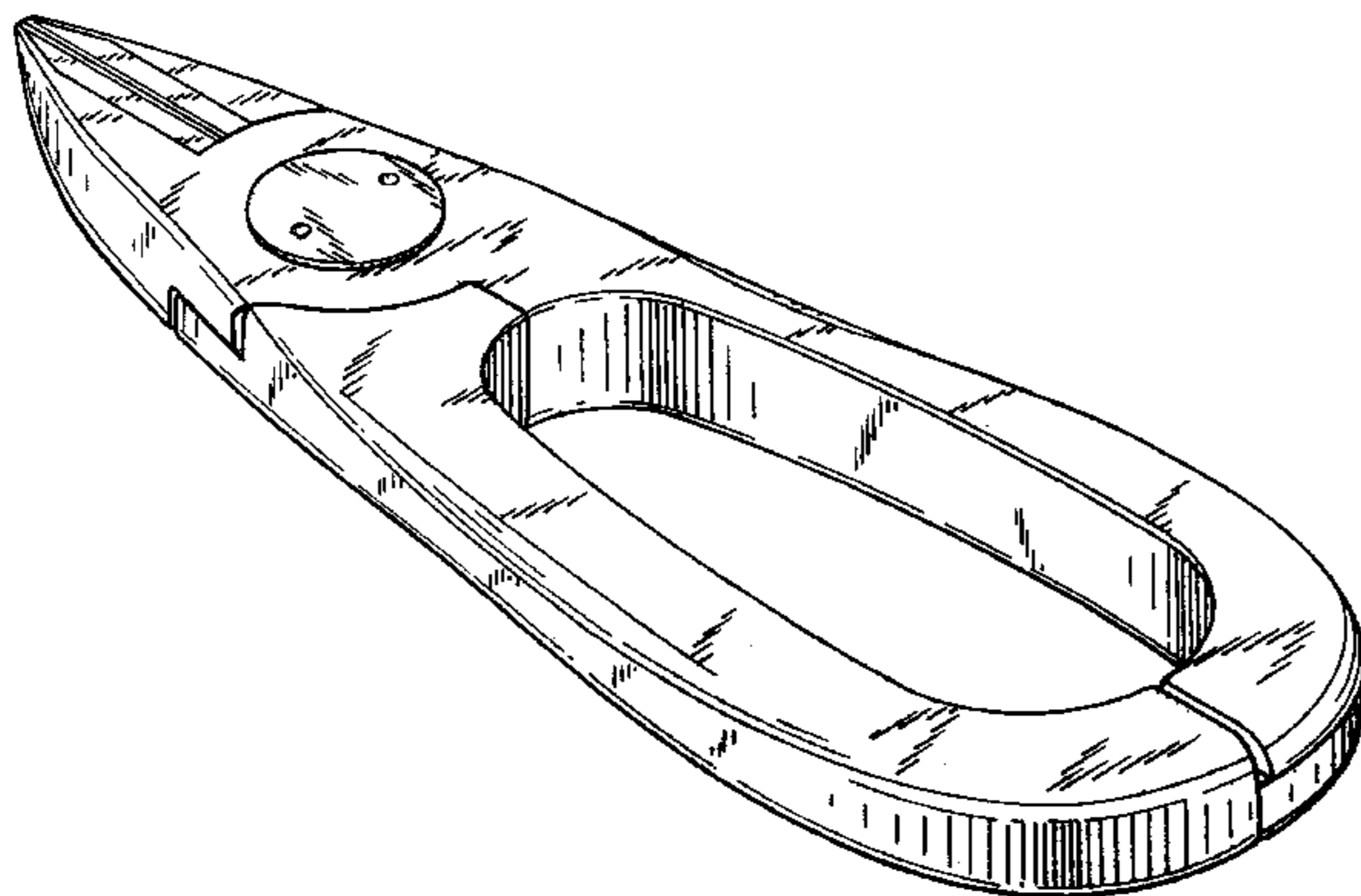

FIG.1

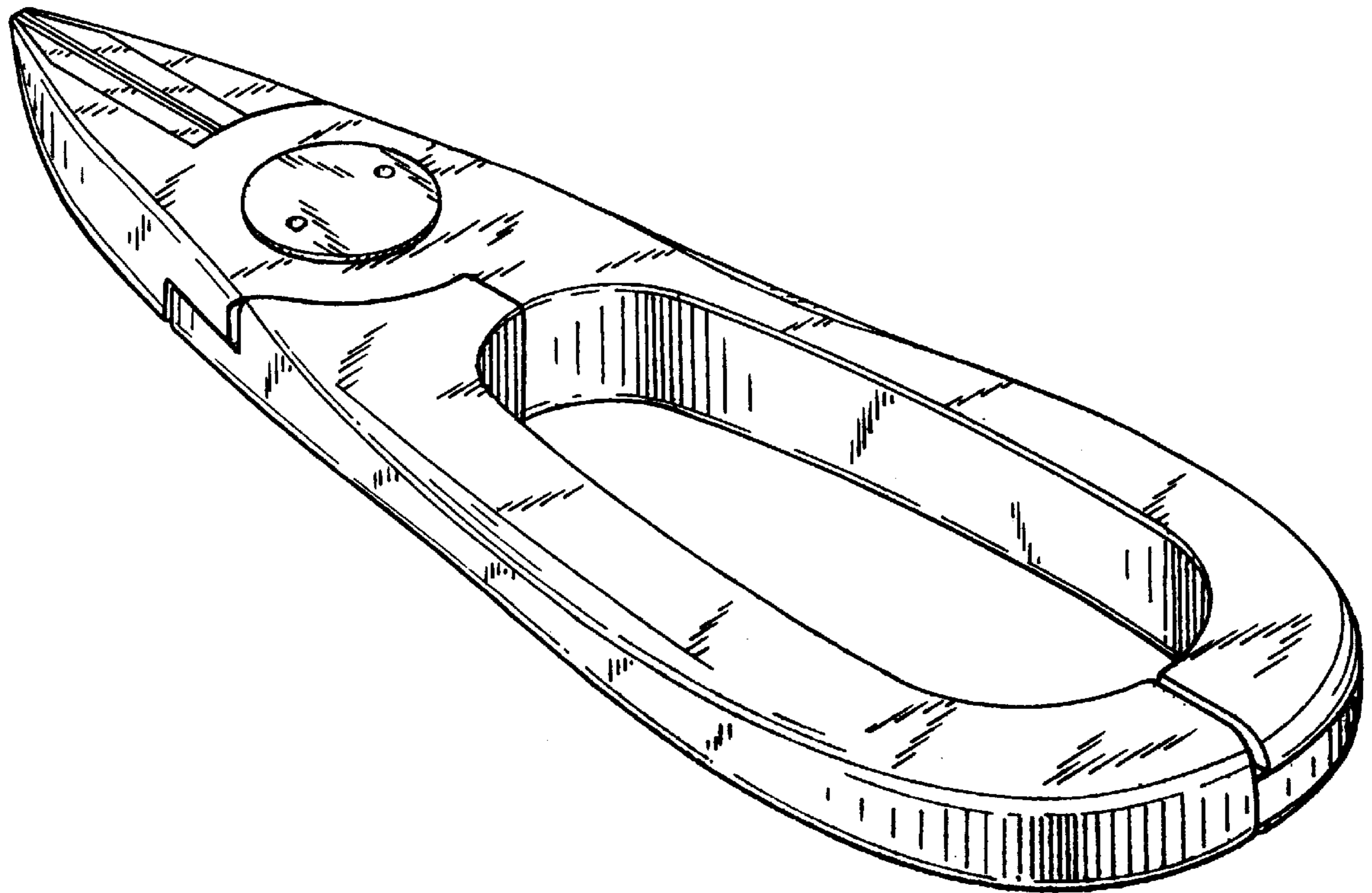

FIG.2

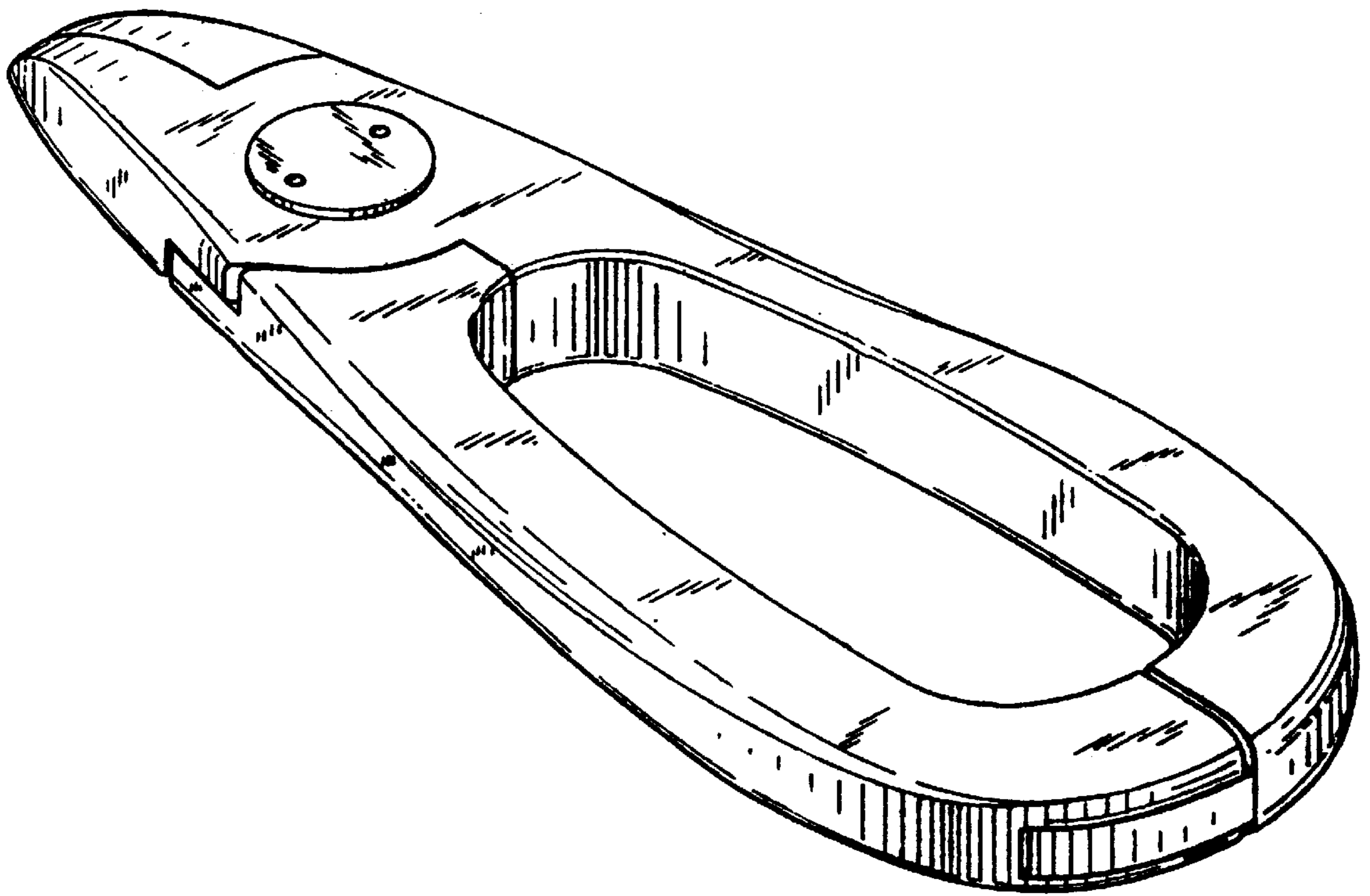

FIG.3

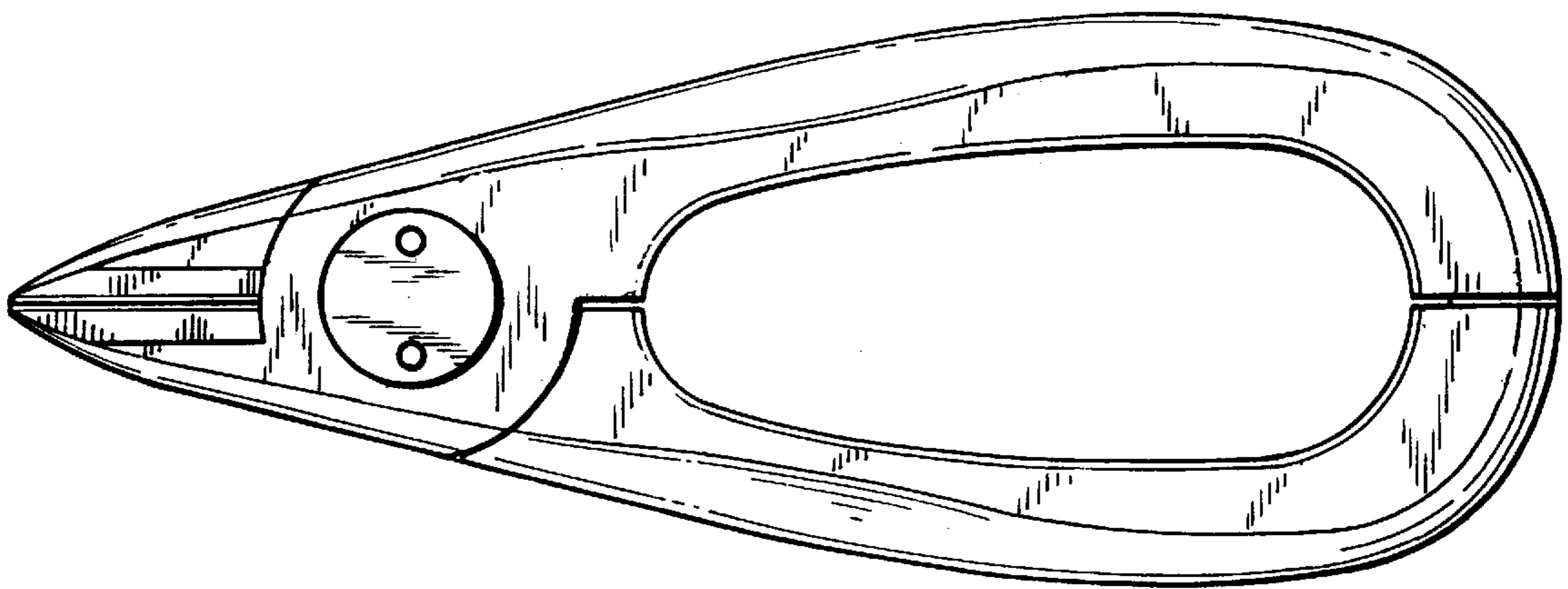

FIG.4

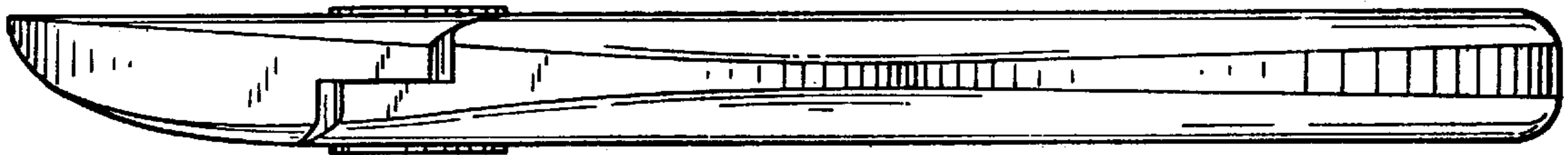

FIG.5

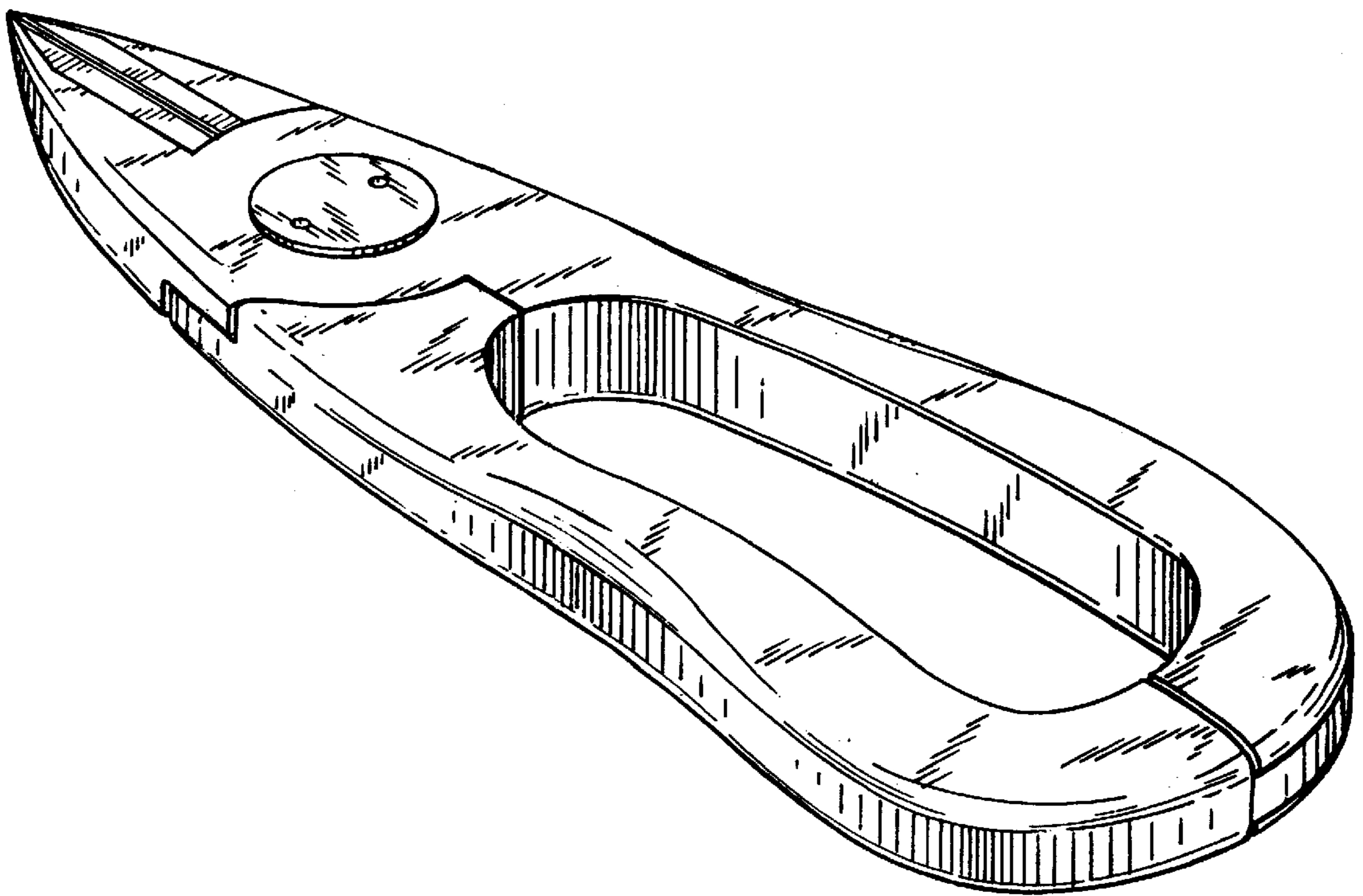

FIG.6

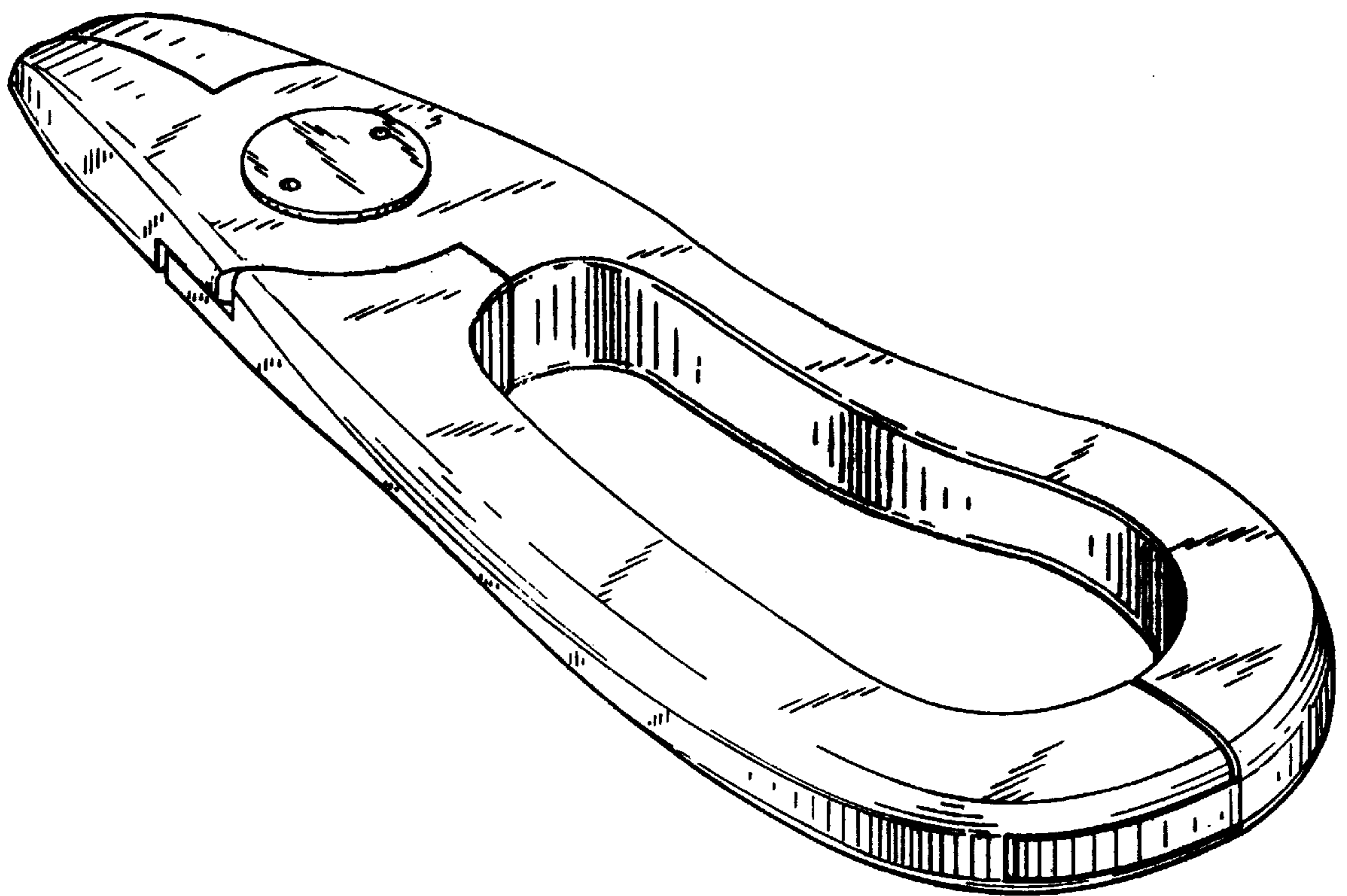

FIG.7

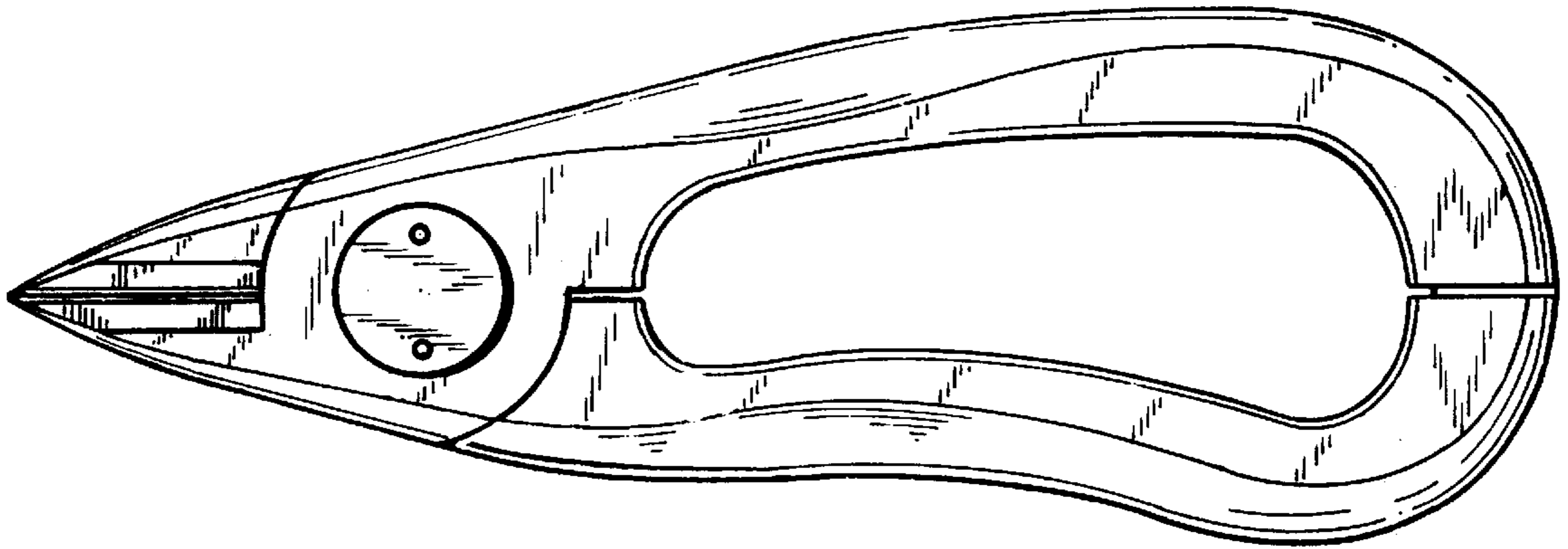

FIG.8

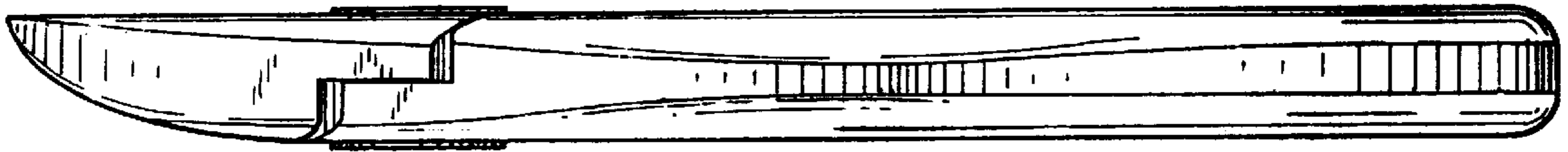

FIG.9

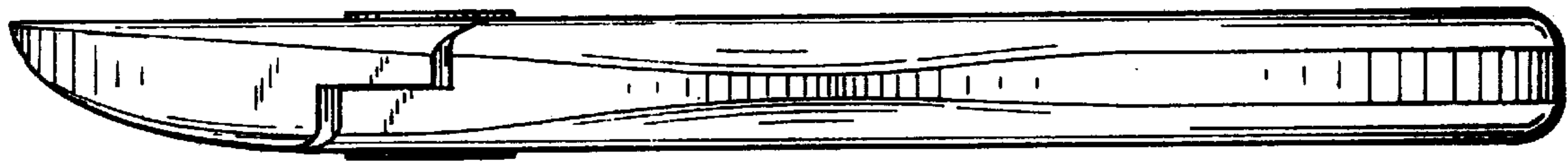
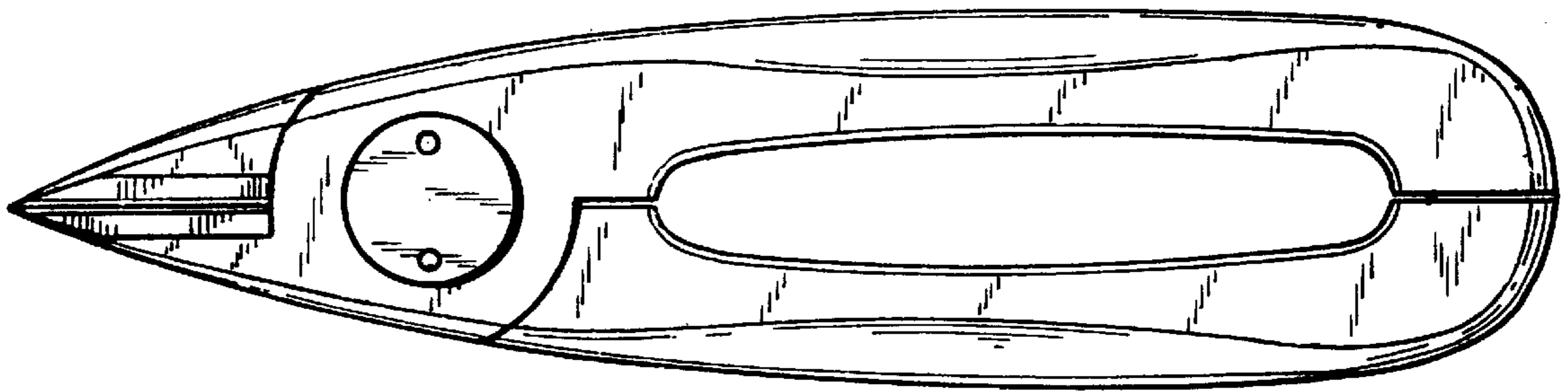

FIG.10

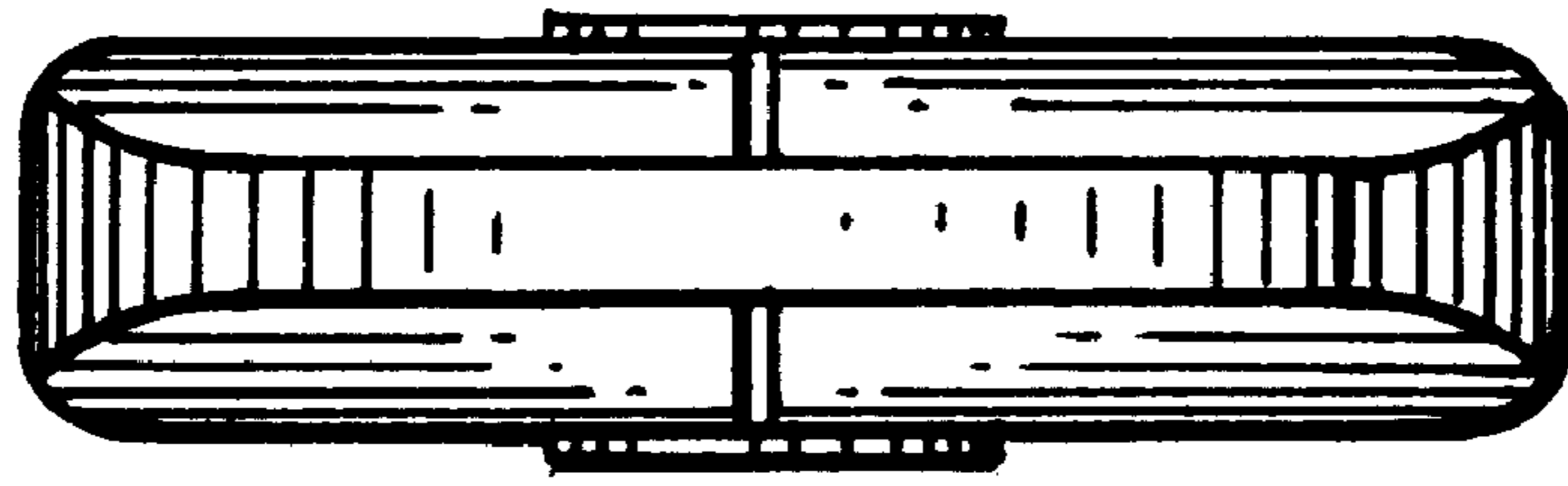

FIG. 11

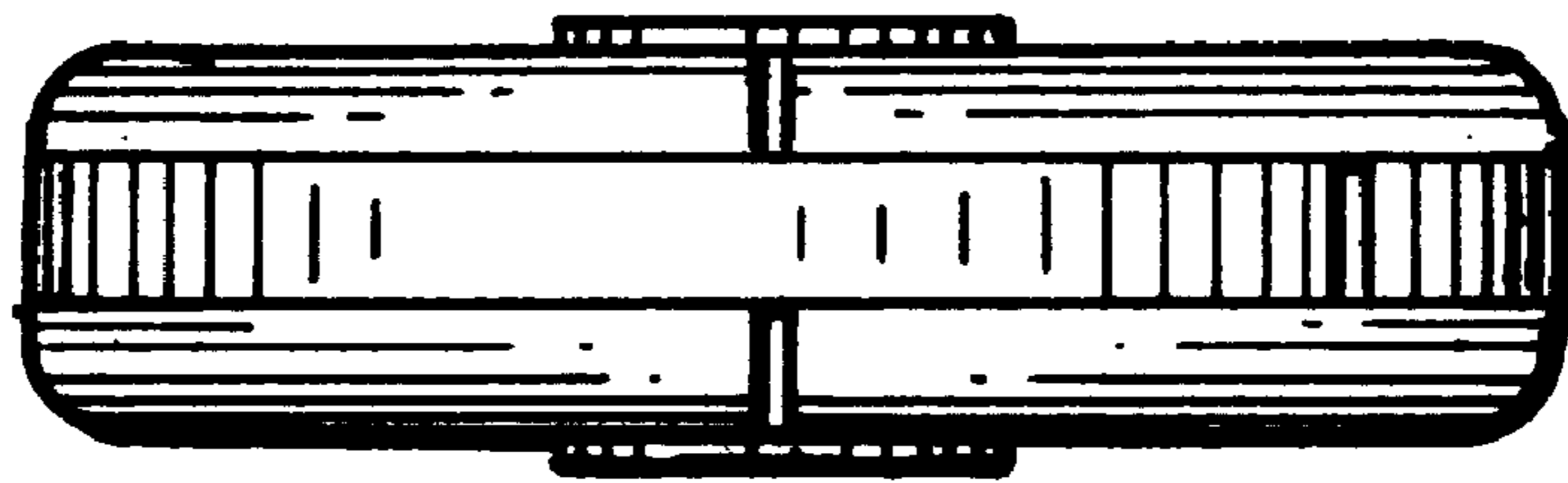

FIG. 12