



US00D434512S

United States Patent [19]

Yuen

[11] Patent Number: Des. 434,512

[45] Date of Patent: ** Nov. 28, 2000

[54] RECHARGEABLE EMERGENCY LIGHT

[75] Inventor: **John Se-Kit Yuen**, Kowloon, The Hong Kong Special Administrative Region of the People's Republic of China

[73] Assignee: **John Manufacturing Limited**, Kowloon, The Hong Kong Special Administrative Region of the People's Republic of China

[**] Term: **14 Years**

[21] Appl. No.: **29/088,052**

[22] Filed: **May 14, 1998**

[30] Foreign Application Priority Data

Nov. 17, 1997 [GB] United Kingdom 2070564

[51] LOC (7) Cl. **26-02**

[52] U.S. Cl. **D26/37**

[58] Field of Search D26/37-50; 362/157, 362/158, 183-191, 194-208

[56] References Cited

U.S. PATENT DOCUMENTS

- D. 336,531 6/1993 Kwong D26/37
- D. 343,015 1/1994 Yuen .
- D. 350,407 9/1994 Yuen D26/37
- D. 361,633 8/1995 Chabria D26/37
- D. 366,127 1/1996 Yuen .
- D. 374,492 10/1996 Coe D26/37

- D. 378,617 3/1997 Yuen D26/37
- D. 380,566 7/1997 Chen D26/37
- D. 384,175 9/1997 Liu D26/38
- D. 390,678 2/1998 Matthes D26/37

FOREIGN PATENT DOCUMENTS

- 2018079 10/1991 United Kingdom .
- 2038382 4/1994 United Kingdom .
- 2051292 10/1995 United Kingdom .

Primary Examiner—Marcus A. Jackson
Attorney, Agent, or Firm—Fay, Sharpe, Beall, Fagan, Minnich & McKee

[57] CLAIM

The ornamental design for a rechargeable emergency light, as shown and described.

DESCRIPTION

FIG. 1 is a front elevational view of a rechargeable emergency light showing my new design;
 FIG. 2 is a left side elevational view thereof;
 FIG. 3 is a rear elevational view thereof;
 FIG. 4 is a right side elevational view thereof;
 FIG. 5 is a top plan view thereof;
 FIG. 6 is an underneath plan view thereof;
 FIG. 7 is a rear elevational view with plug extended thereof;
 FIG. 8 is a right side elevational view with plug extended thereof; and,
 FIG. 9 is an underneath plan view with plug extended.

1 Claim, 3 Drawing Sheets

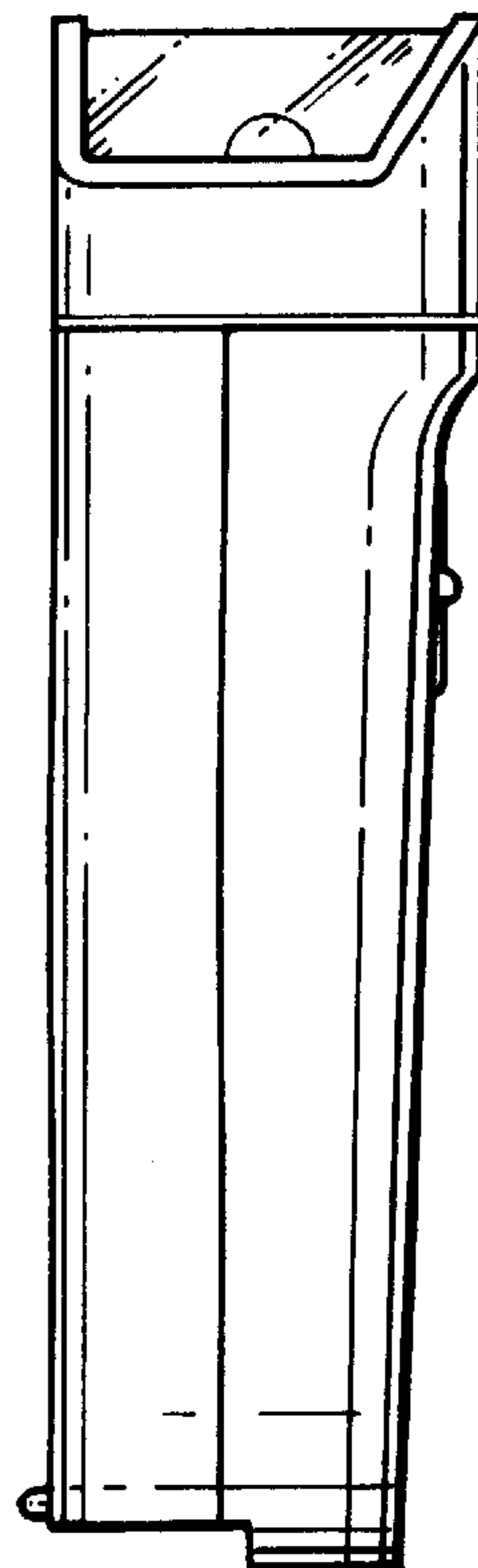
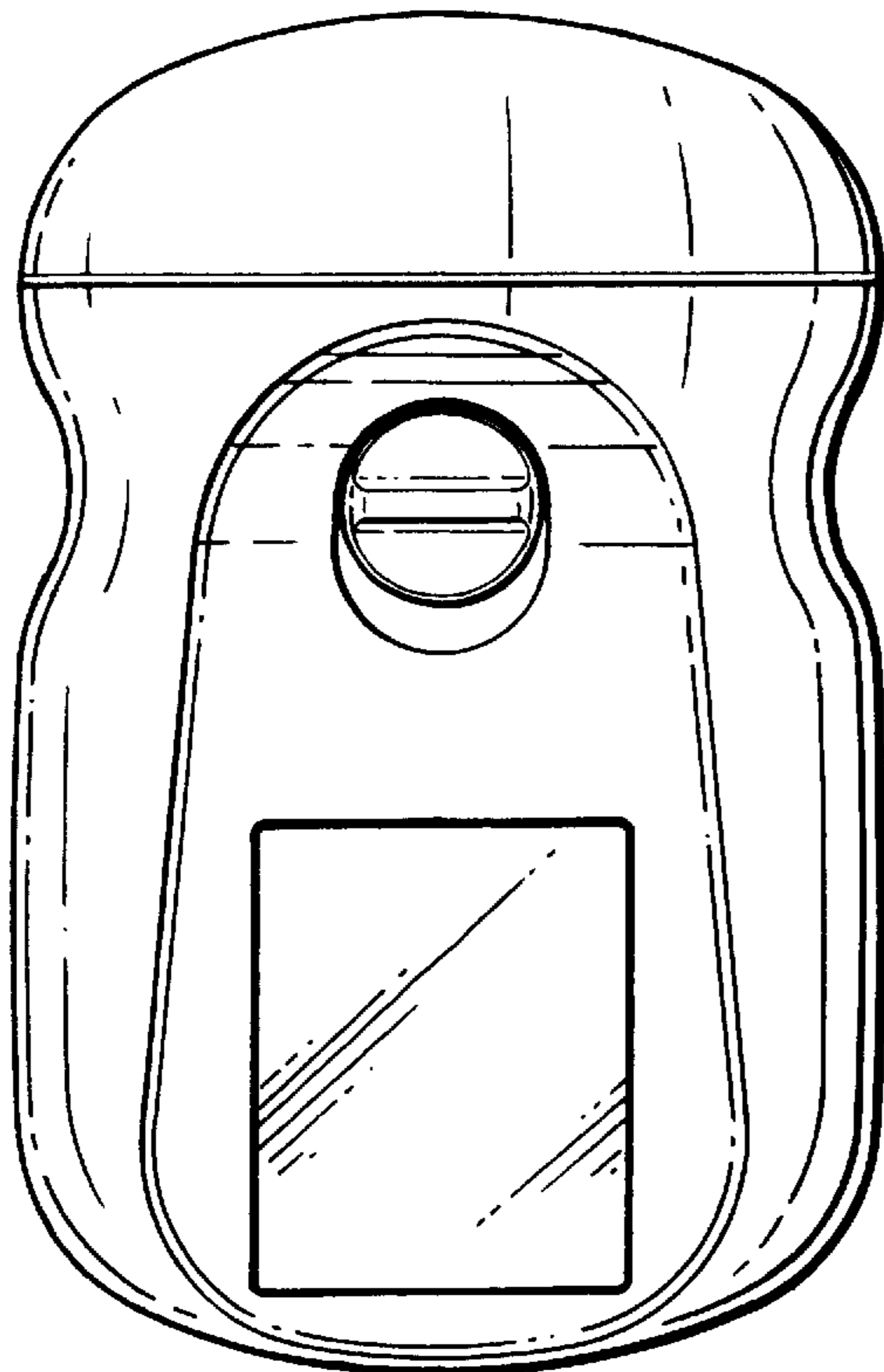

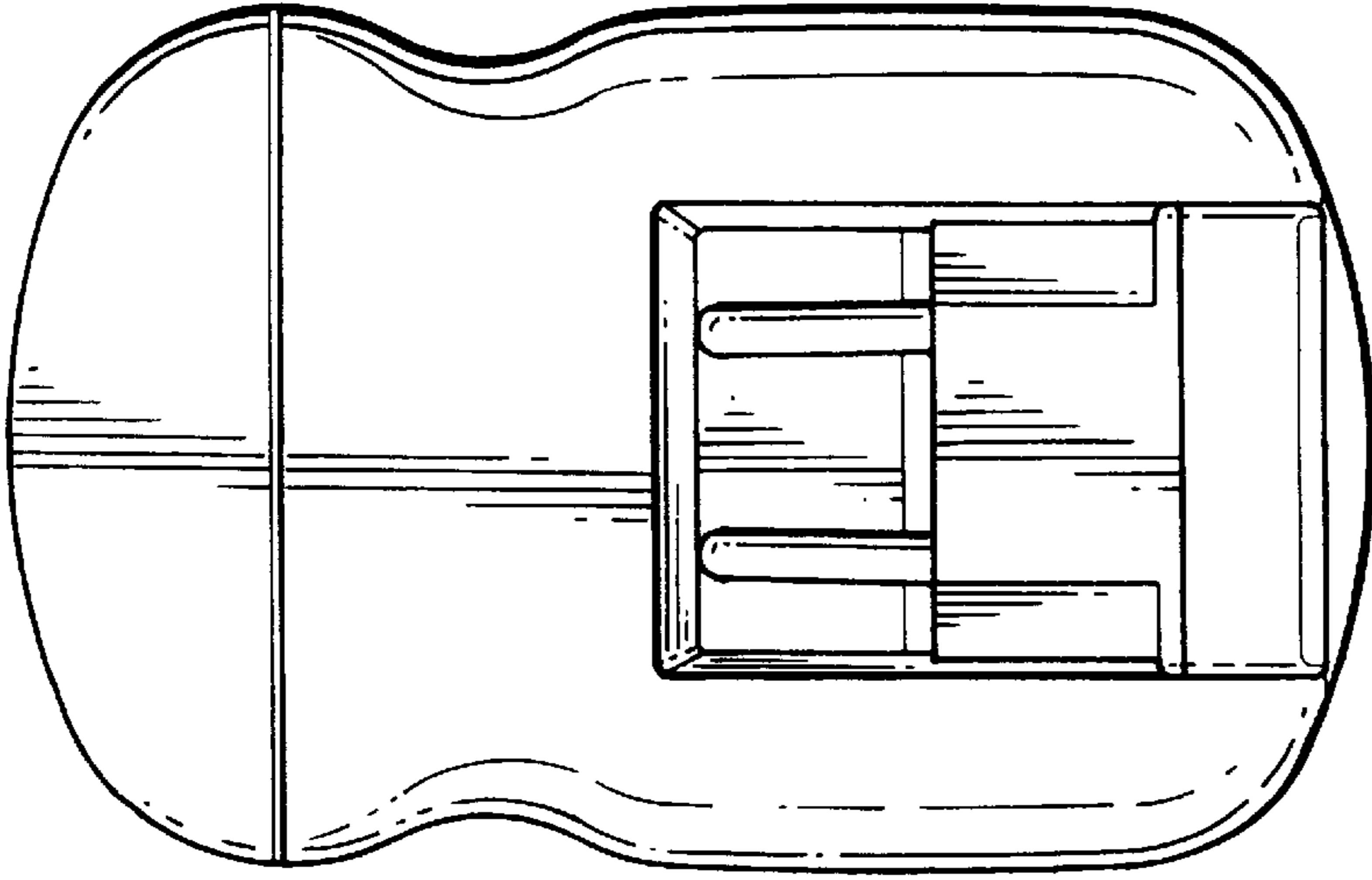

FIG. 1

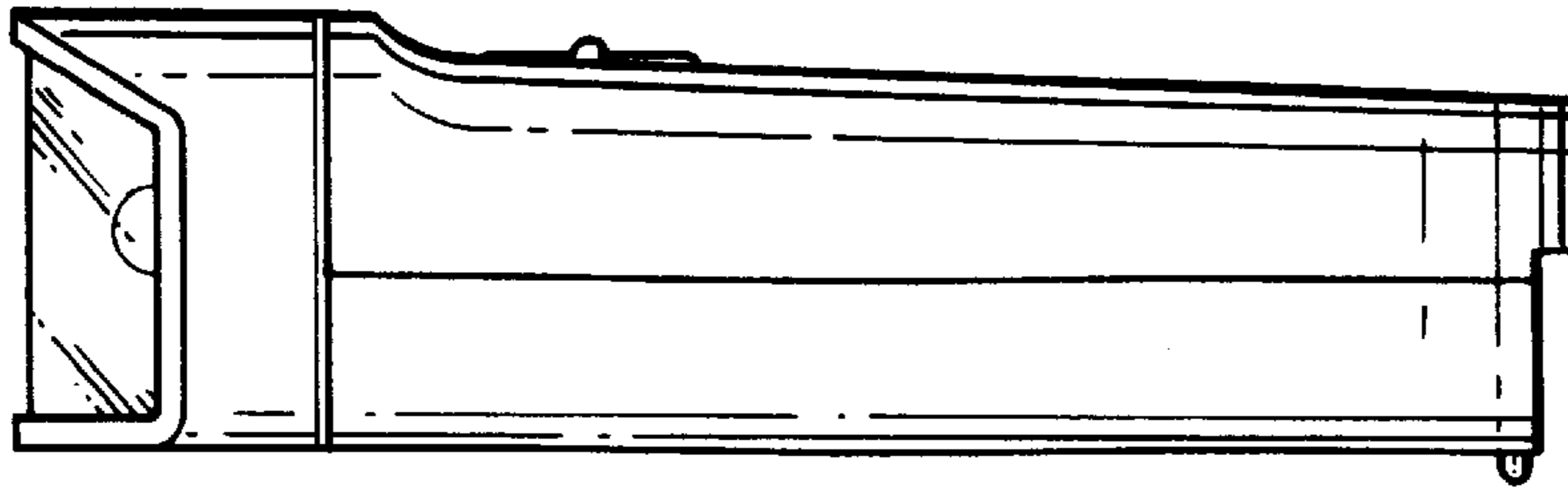

FIG. 2

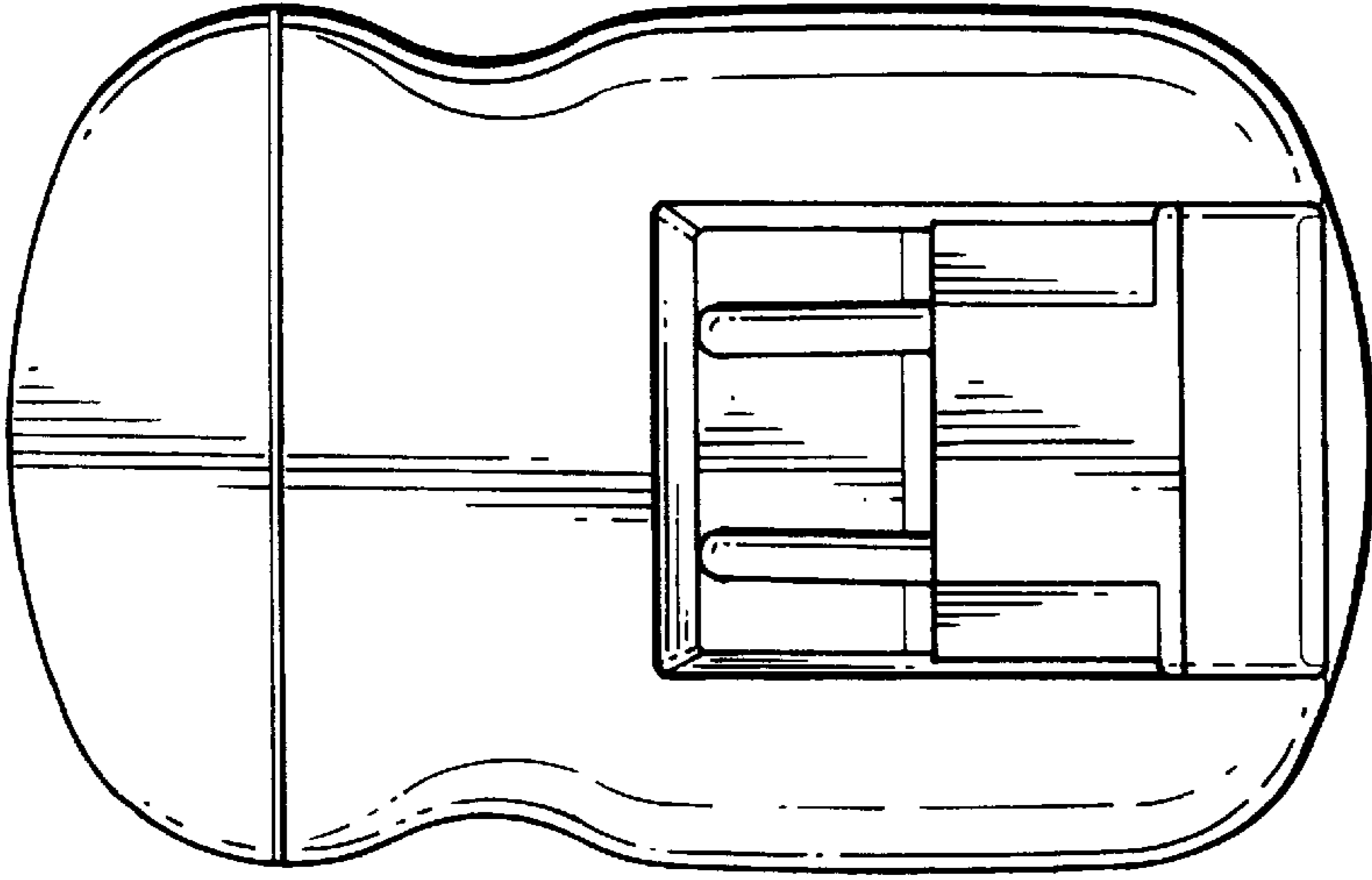

FIG. 3

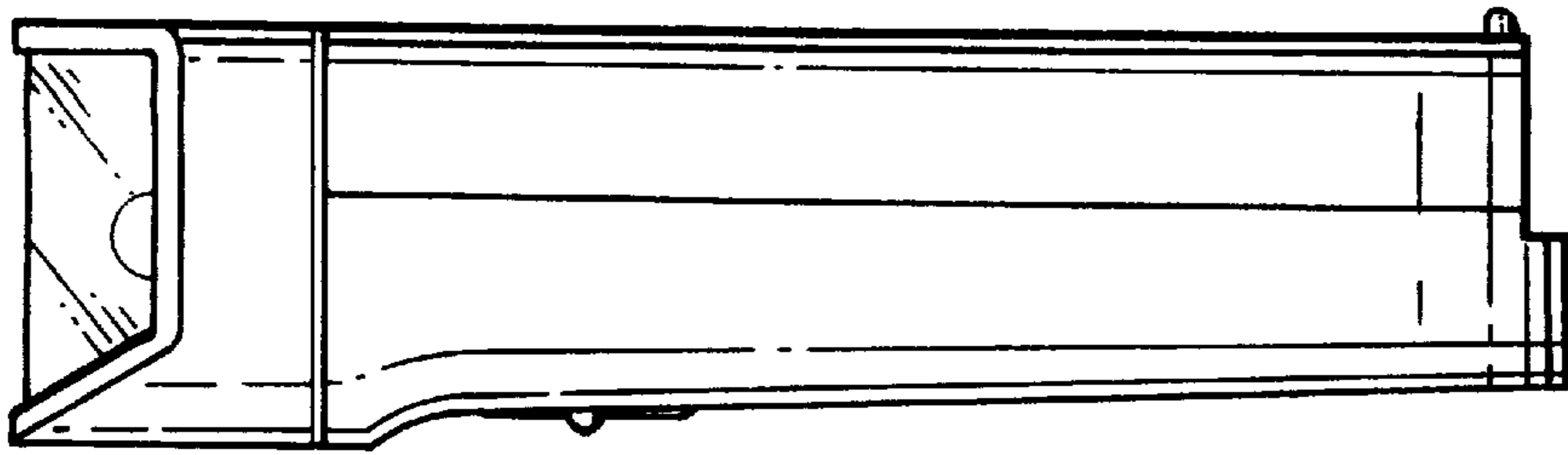

FIG. 4

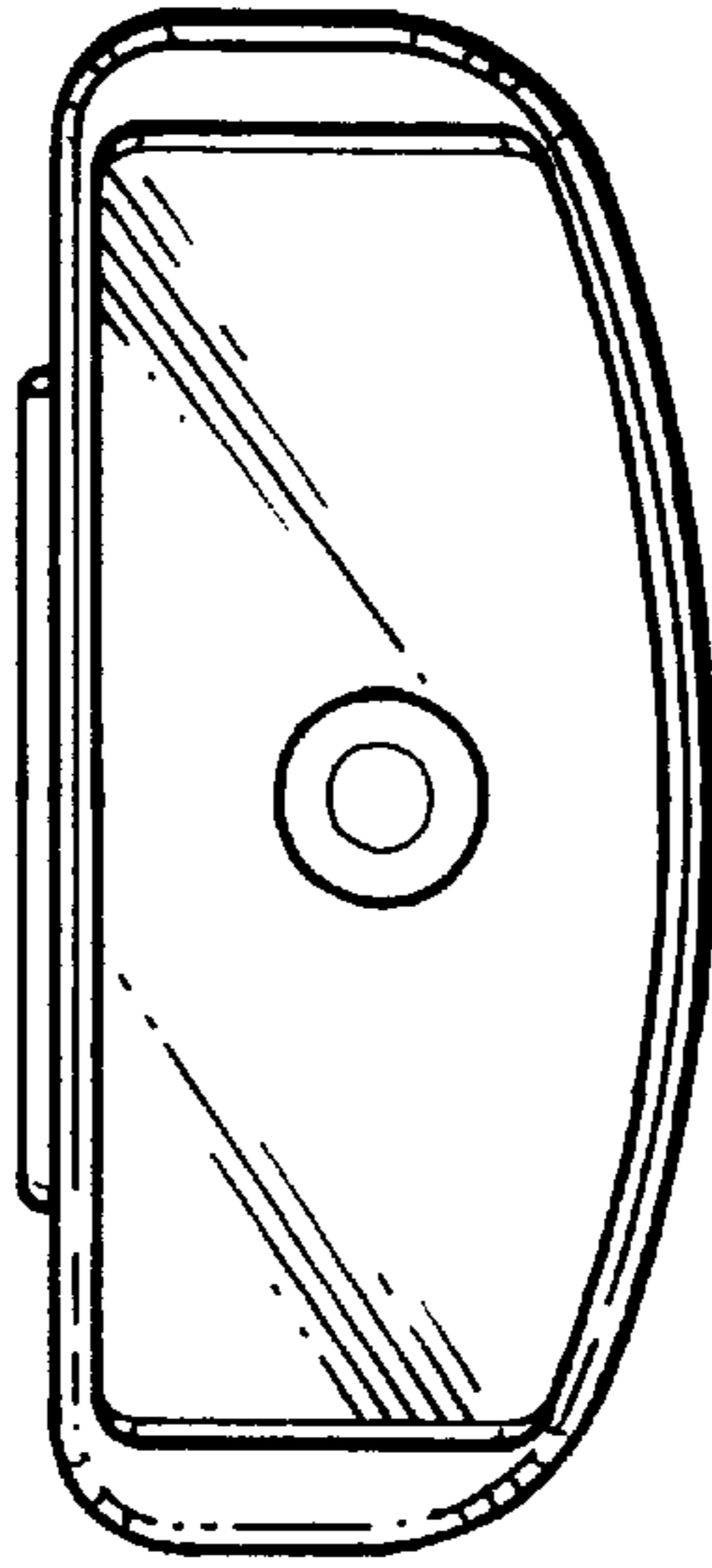

FIG. 5

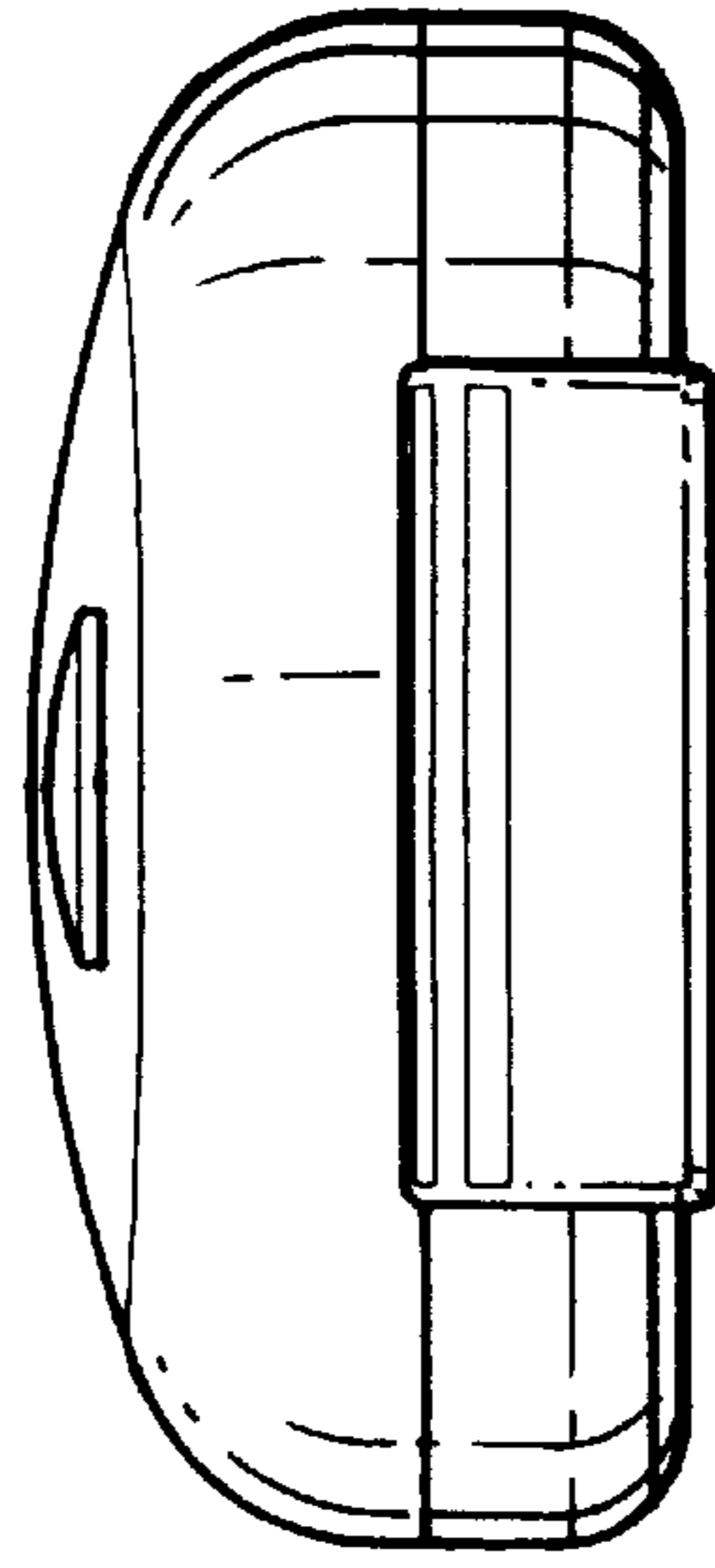

FIG. 6

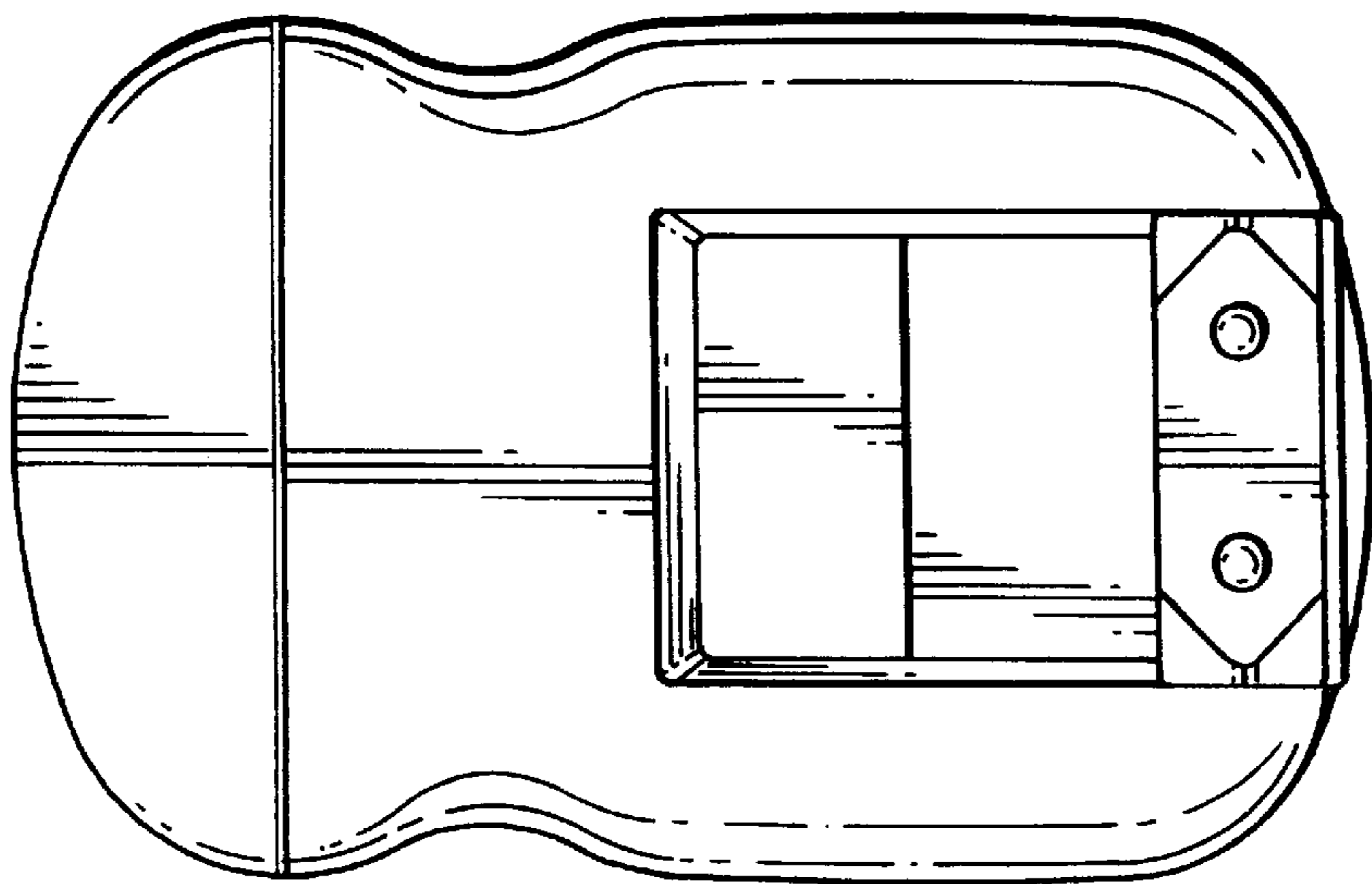

FIG. 7

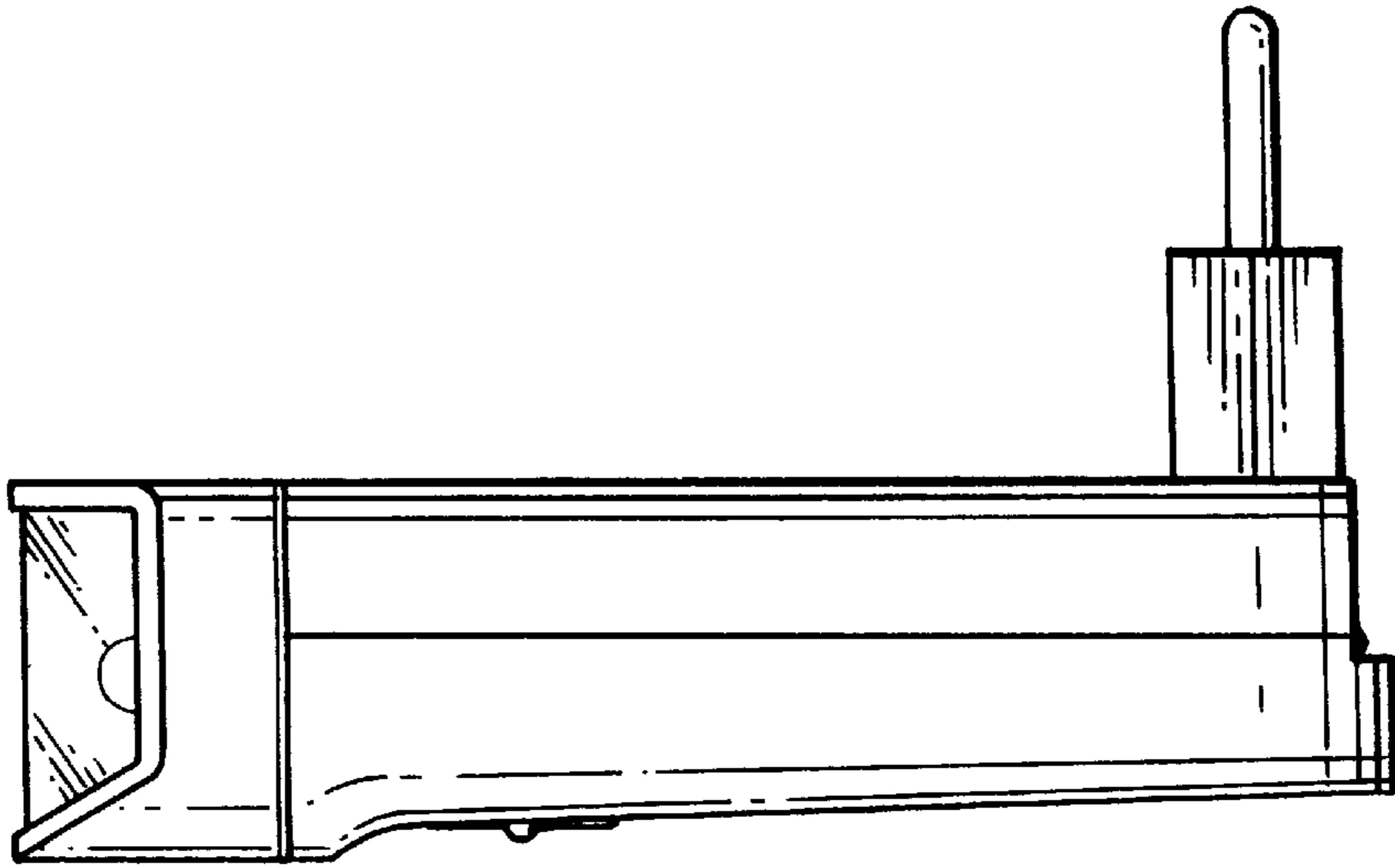

FIG. 8

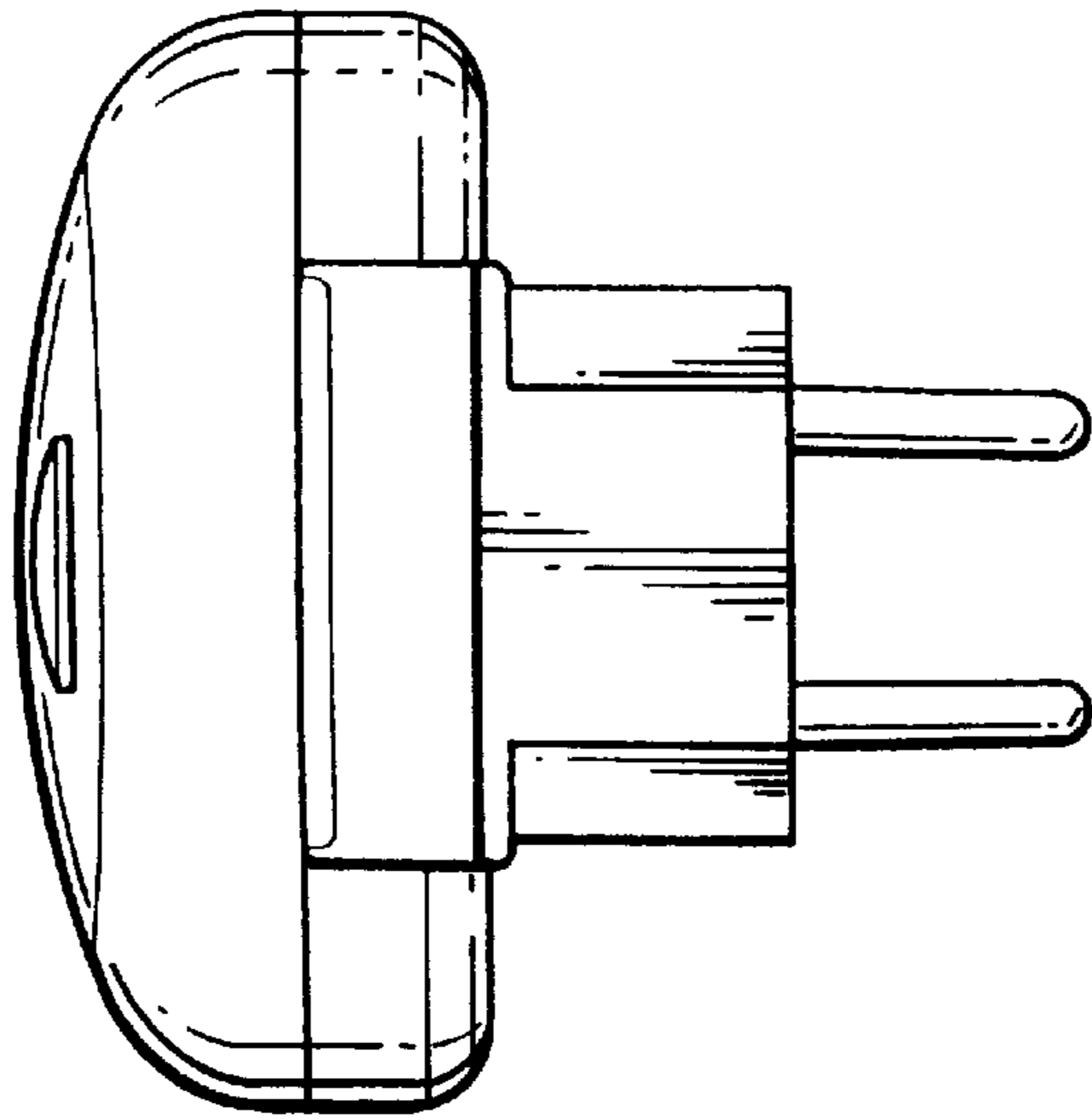

FIG. 9