



US00D434437S

# United States Patent [19]

[11] Patent Number: Des. 434,437

Mackevicius et al.

[45] Date of Patent: \*\* Nov. 28, 2000

[54] DAMPING WATER CONDITIONING AND RECIRCULATING APPARATUS FOR A DAMPING WATER OFFSET PRINTING MACHINE

Primary Examiner—Robin V. Taylor  
Attorney, Agent, or Firm—Ostrolenk, Faber, Gerb & Soffen, LLP

[75] Inventors: Angelika Mackevicius, Augsburg;  
Georg Lechner, Aichach, both of Germany

### [57] CLAIM

The ornamental design for a damping water conditioning and recirculating apparatus for a damping water offset printing machine, as shown and described.

[73] Assignee: Baldwin Grafotec GmbH, Germany

### DESCRIPTION

[\*\*] Term: 14 Years

[21] Appl. No.: 29/112,769

[22] Filed: Oct. 22, 1999

### [30] Foreign Application Priority Data

Apr. 23, 1999	[DE]	Germany	.....	4 99 04 162
May 3, 1999	[DE]	Germany	.....	4 99 04 552

FIG. 1 is a front view of a damping water conditioning and recirculating apparatus for a damping water offset printing machine showing our new design;  
 FIG. 2 is a right side view thereof;  
 FIG. 3 is a rear view thereof;  
 FIG. 4 is a top view thereof;  
 FIG. 5 is a left side view thereof;  
 FIG. 6 is a bottom view thereof;  
 FIG. 7 is a front view of a second embodiment of a damping water conditioning and recirculating apparatus for a damping water offset printing machine showing our new design;  
 FIG. 8 is a right side view thereof;  
 FIG. 9 is a rear view thereof;  
 FIG. 10 is a top view thereof;  
 FIG. 11 is a left side view thereof;  
 FIG. 12 is a bottom view thereof;  
 FIG. 13 is a front view of a third embodiment of a damping water conditioning and recirculating apparatus for a damping water offset printing machine showing our new design;  
 FIG. 14 is a right side view thereof;  
 FIG. 15 is a rear view thereof;  
 FIG. 16 is a top view thereof;  
 FIG. 17 is a left side view thereof; and,  
 FIG. 18 is a bottom view thereof.

[51] LOC (7) Cl. .... 18-02

[52] U.S. Cl. .... D18/56; D23/200

[58] Field of Search ..... D23/200, 207,  
D23/209; D18/50, 53, 56; 101/147, 148,  
487

### [56] References Cited

#### U.S. PATENT DOCUMENTS

D. 249,052	8/1978	Hansrote	.....	D23/207
D. 370,050	5/1996	Dea et al.	.....	D23/207
D. 412,734	8/1999	Schroer	.....	D23/207
4,146,474	3/1979	Kagatani	.....	101/147
5,177,975	1/1993	Mertens	.....	101/487

#### OTHER PUBLICATIONS

*Refrigerated Fountain Solution Circulators*, published May 1999.

*Programa general*, published May 1992.

1 Claim, 6 Drawing Sheets

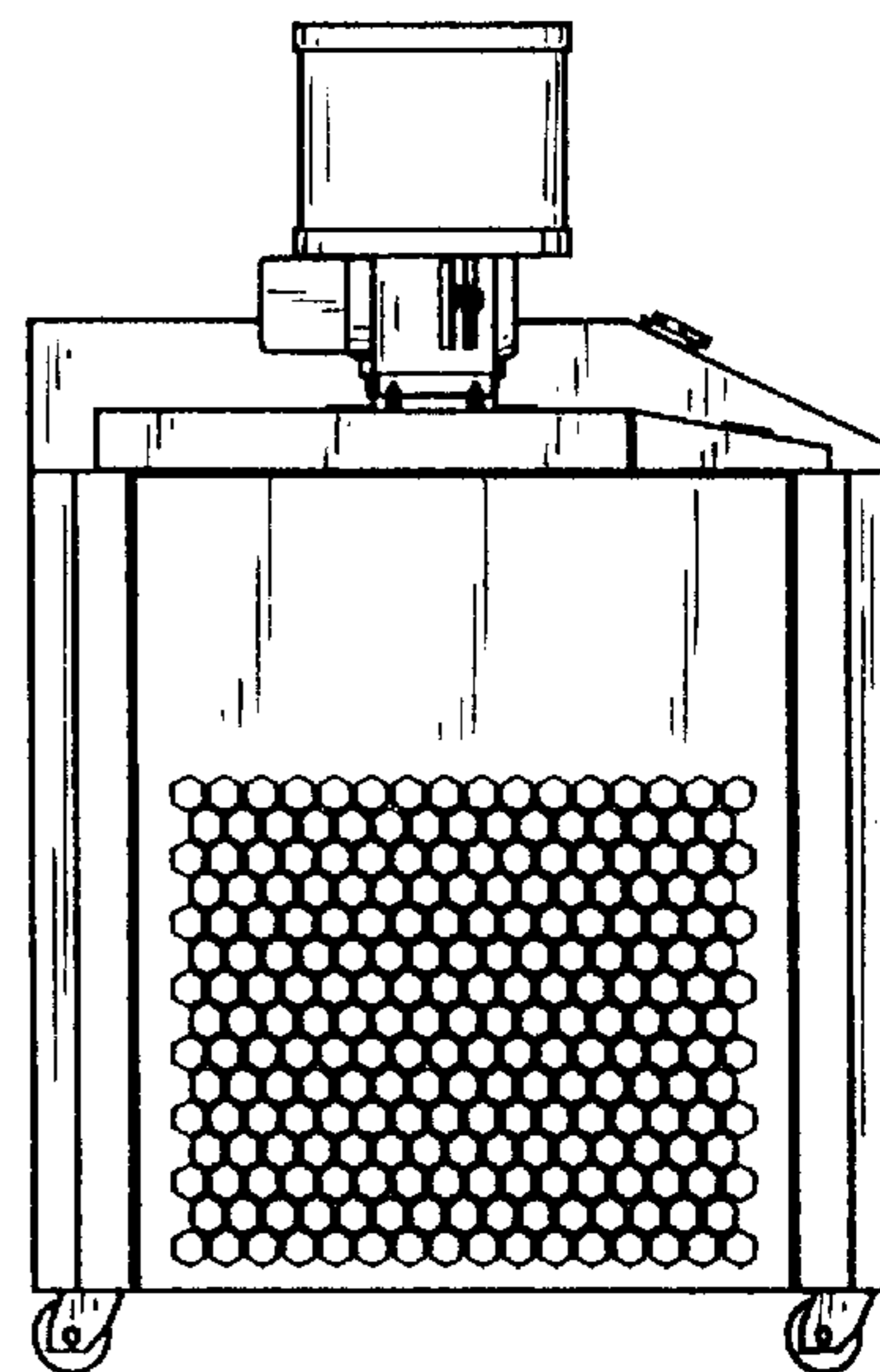
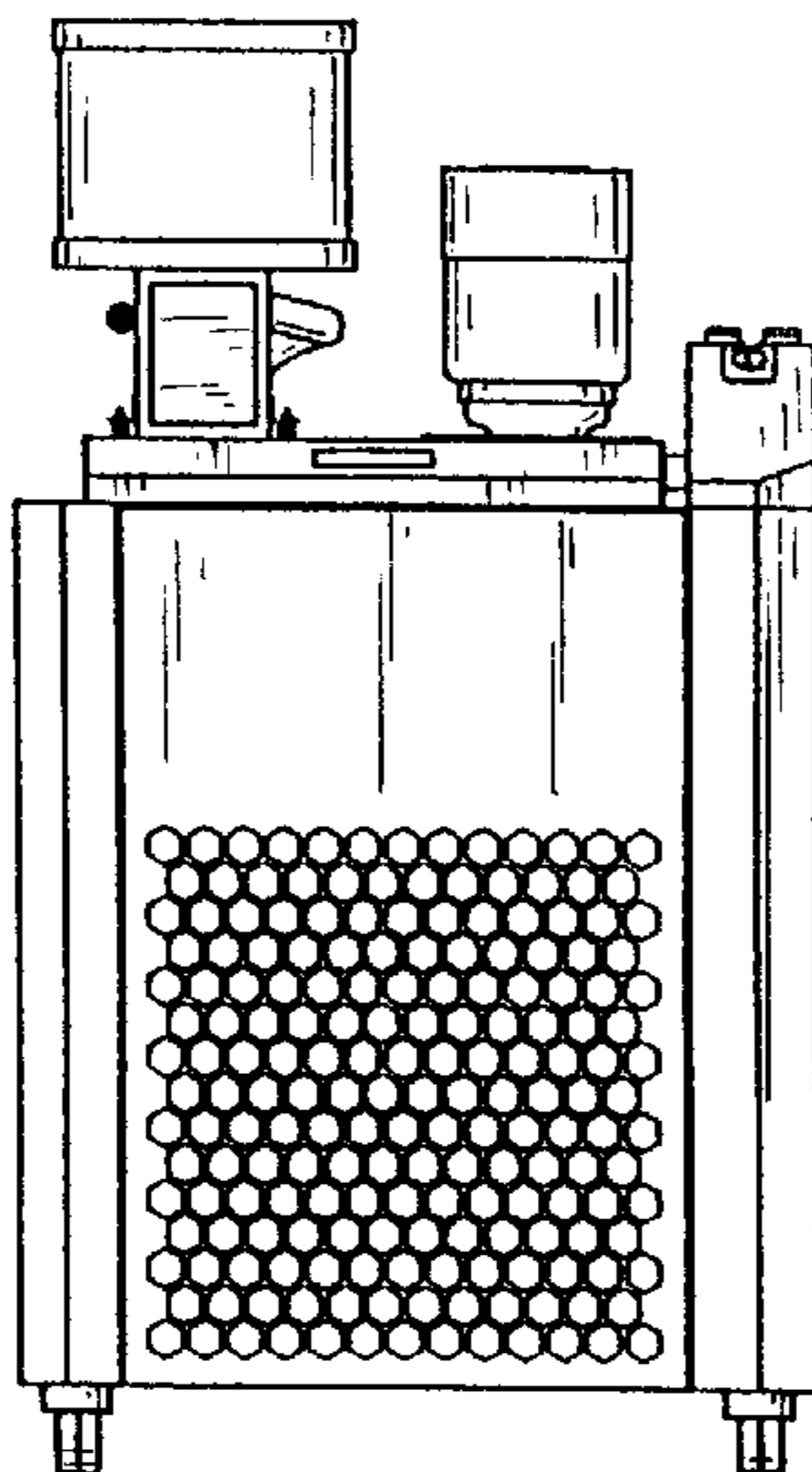
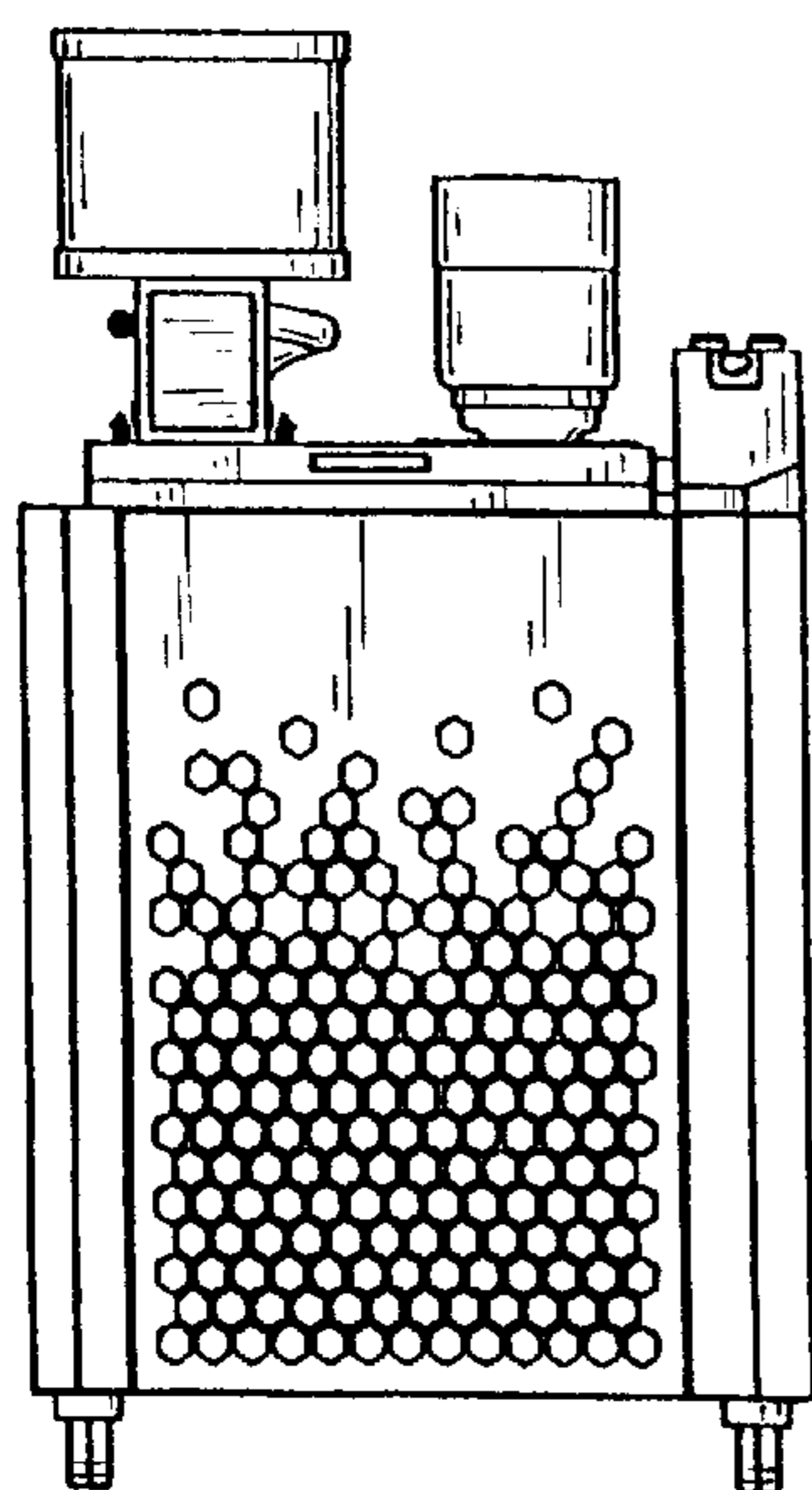

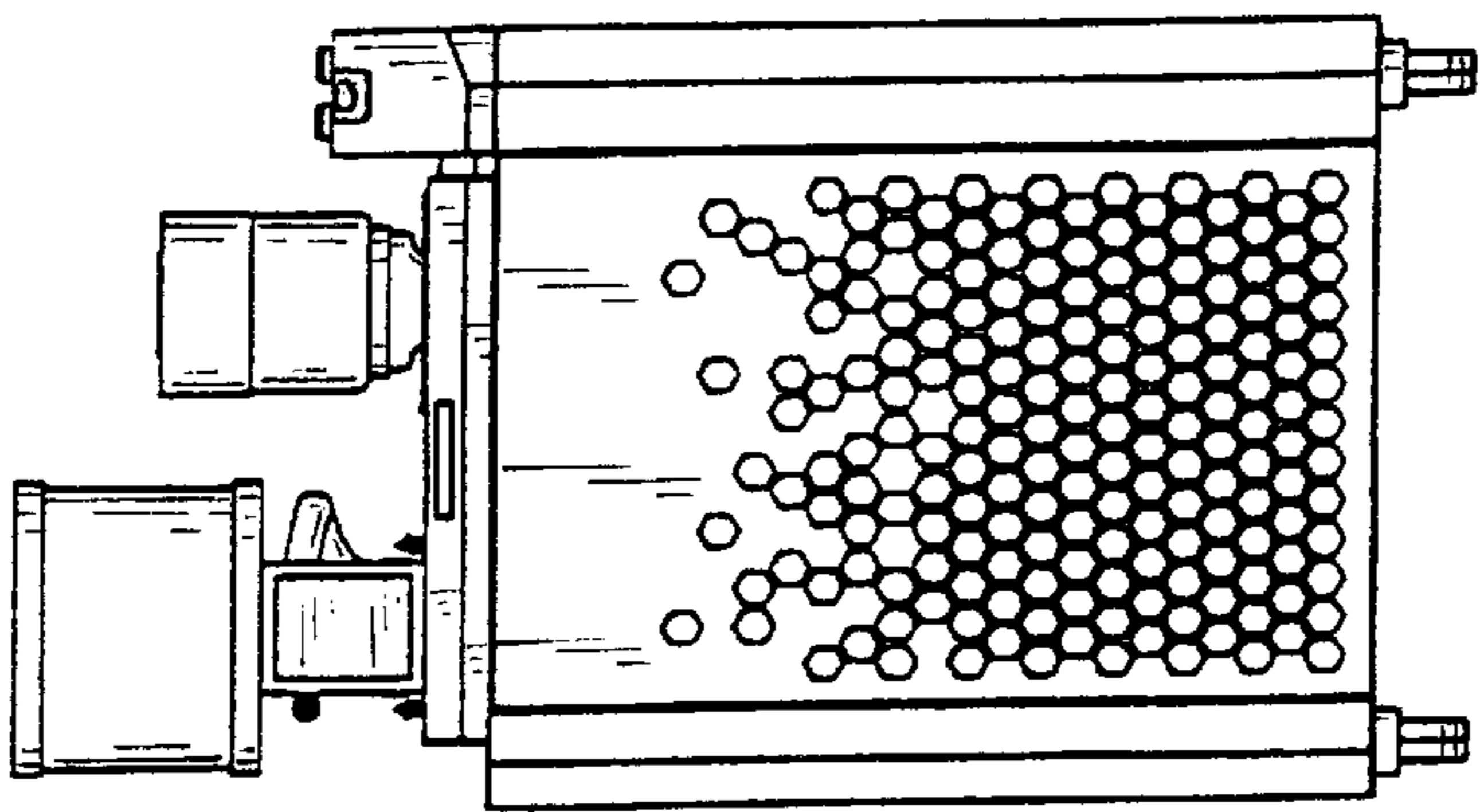

Fig. 1

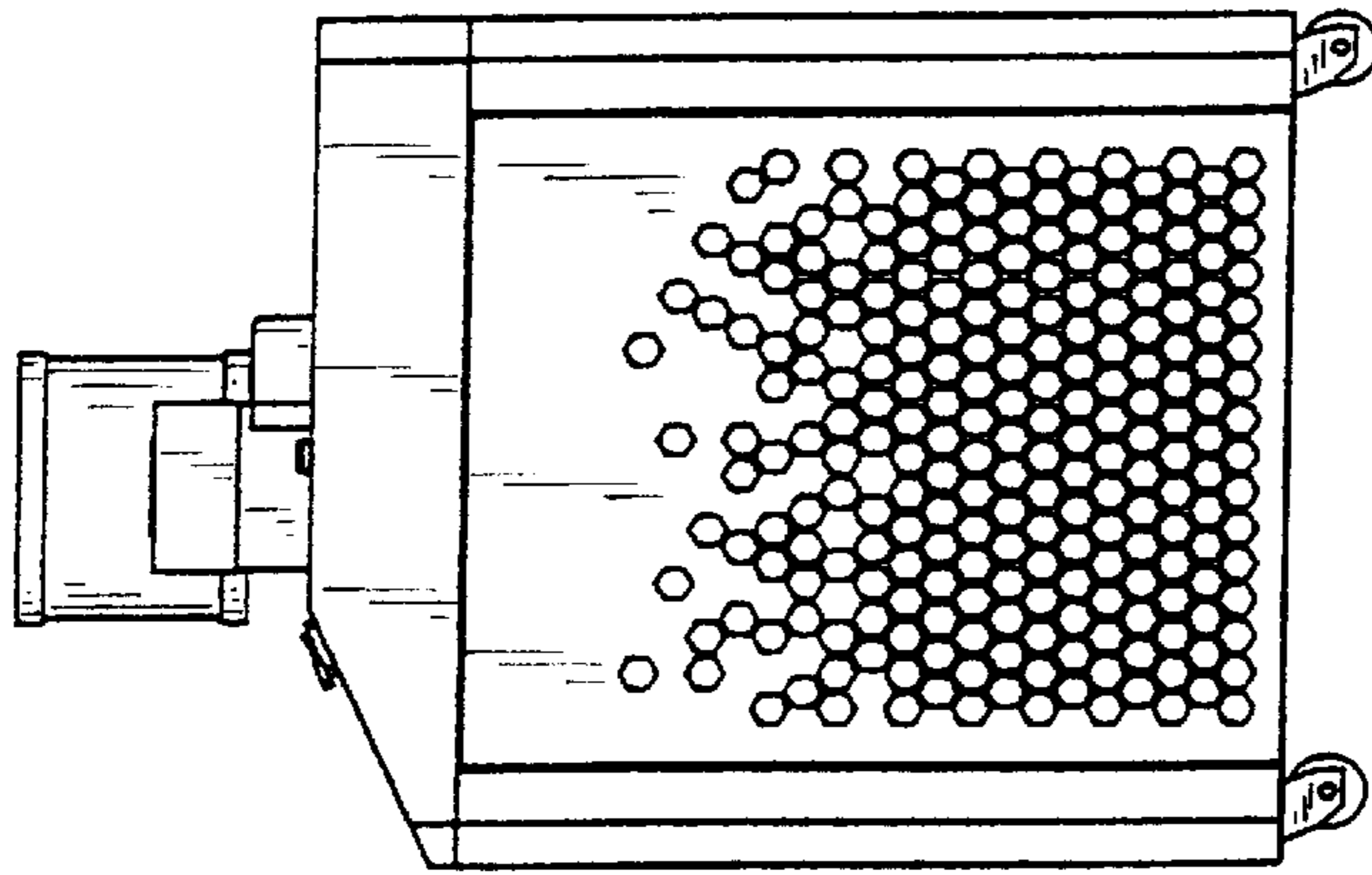

Fig. 2

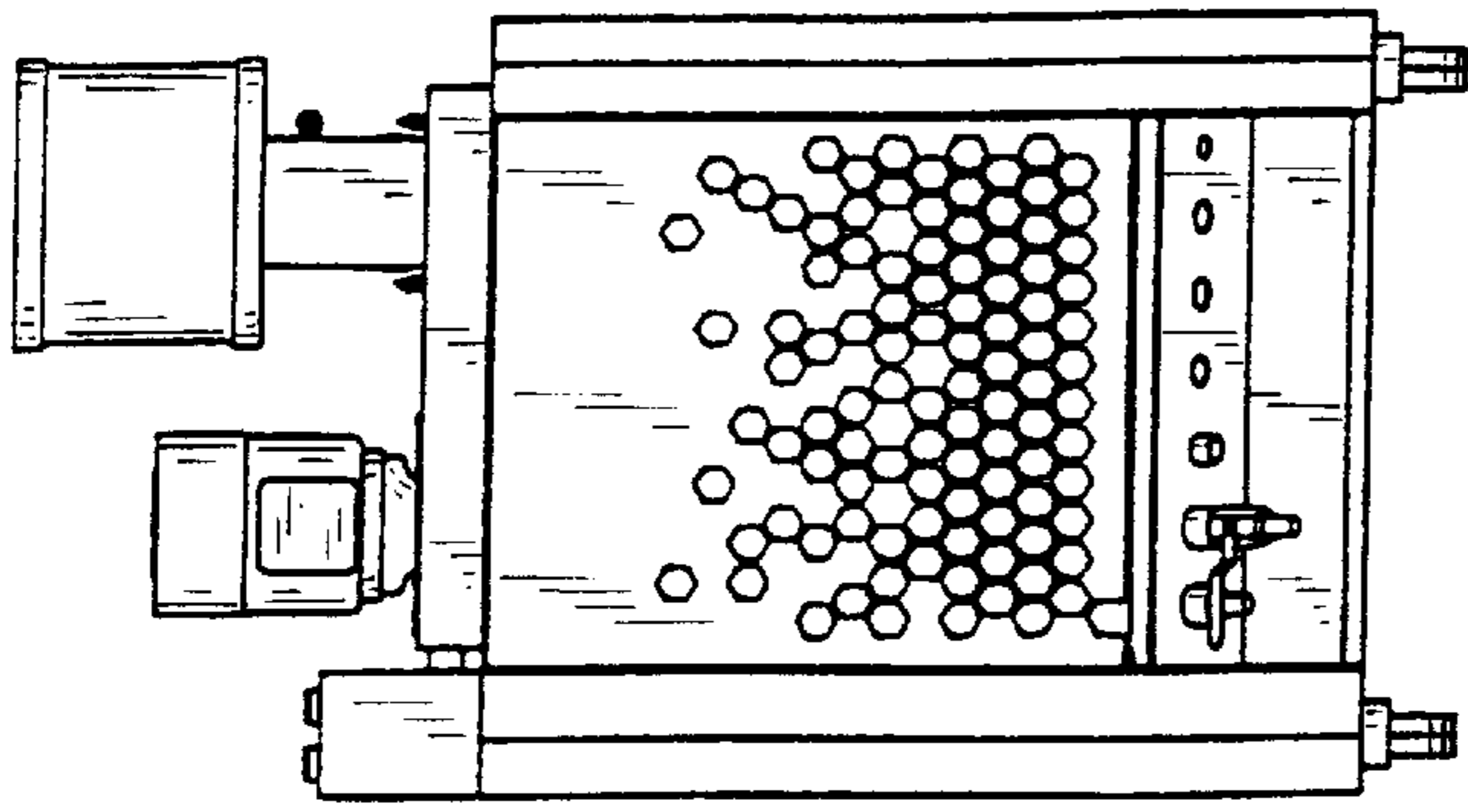

Fig. 3

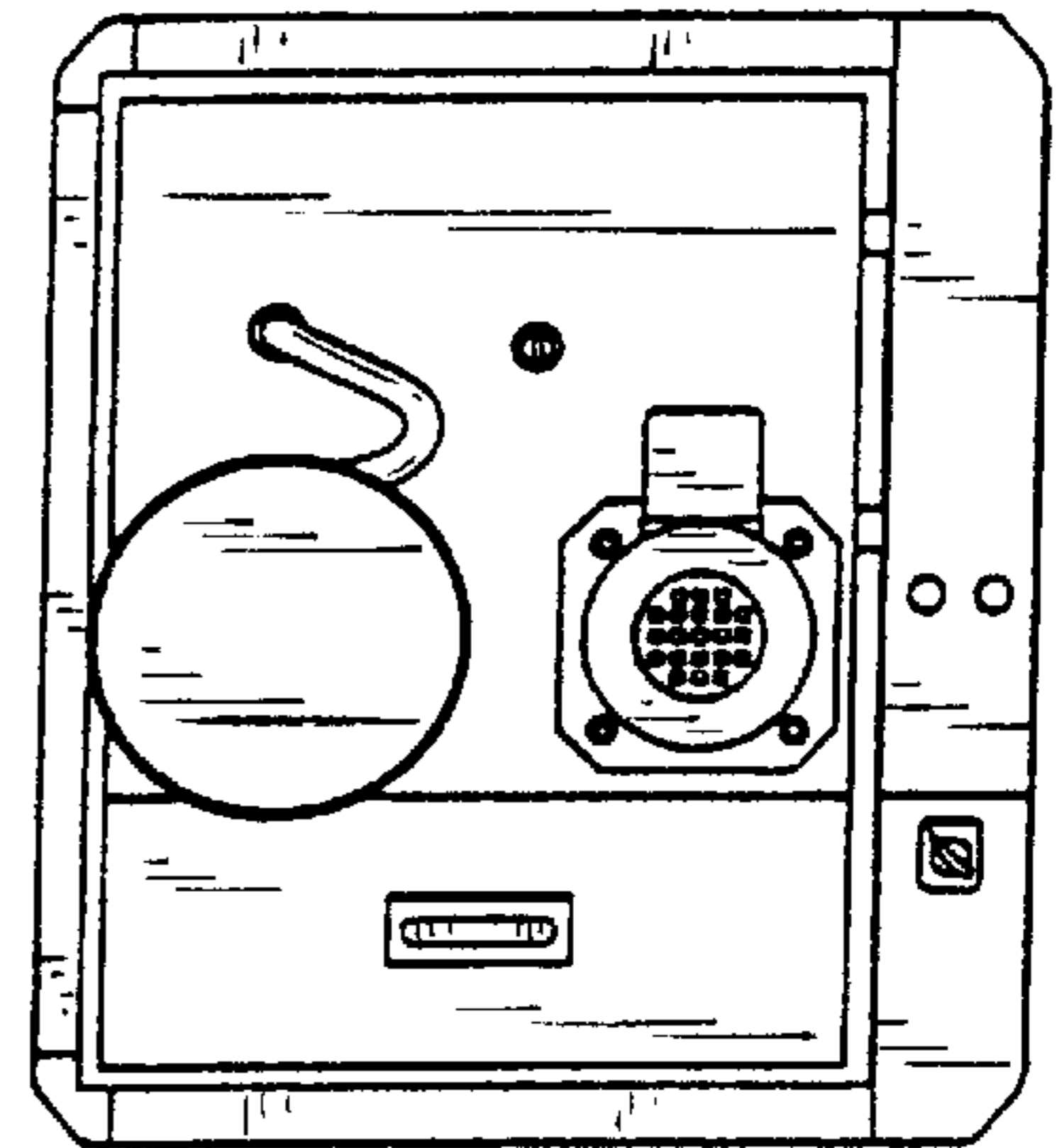

Fig. 4

Fig. 5

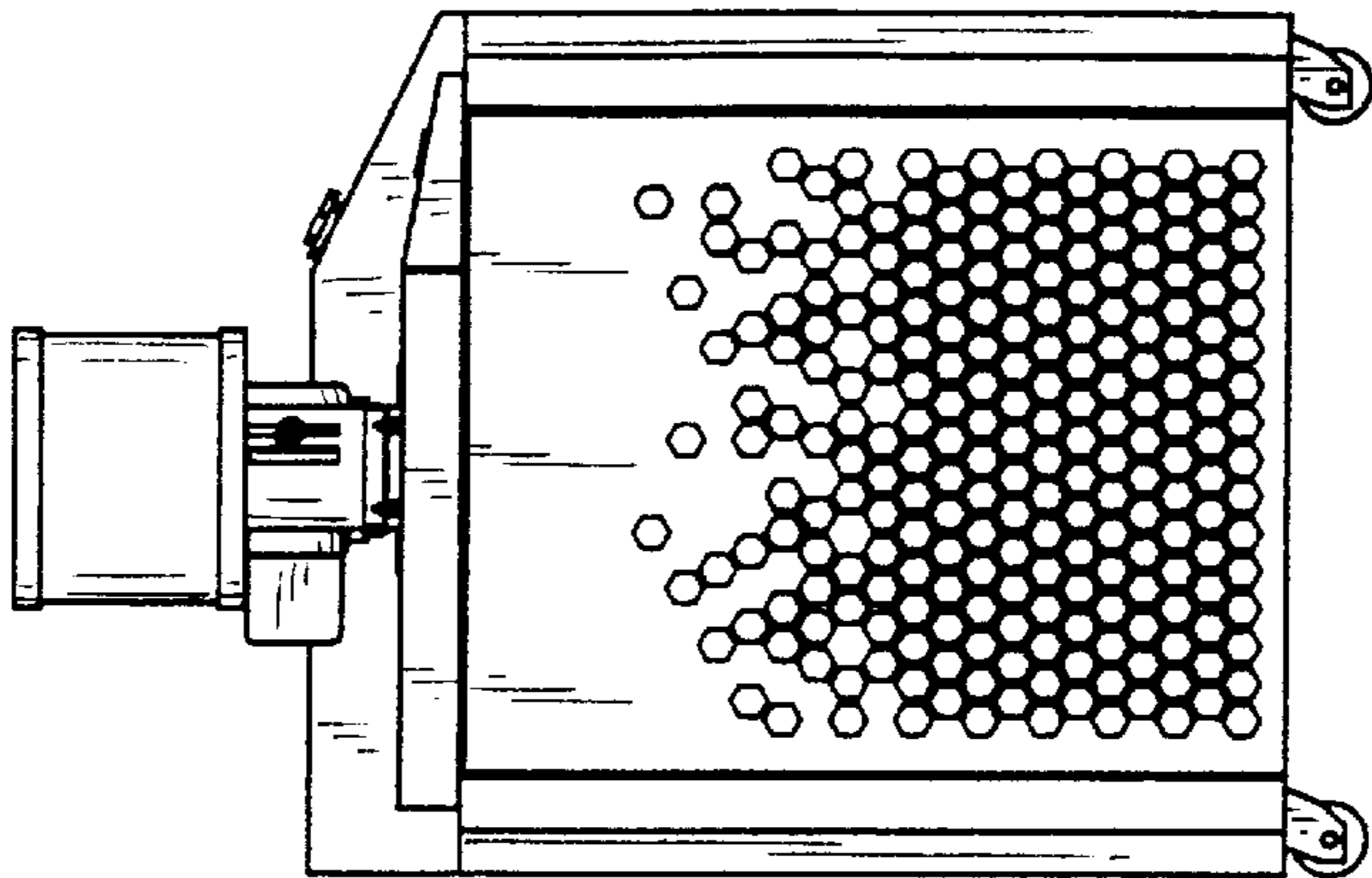
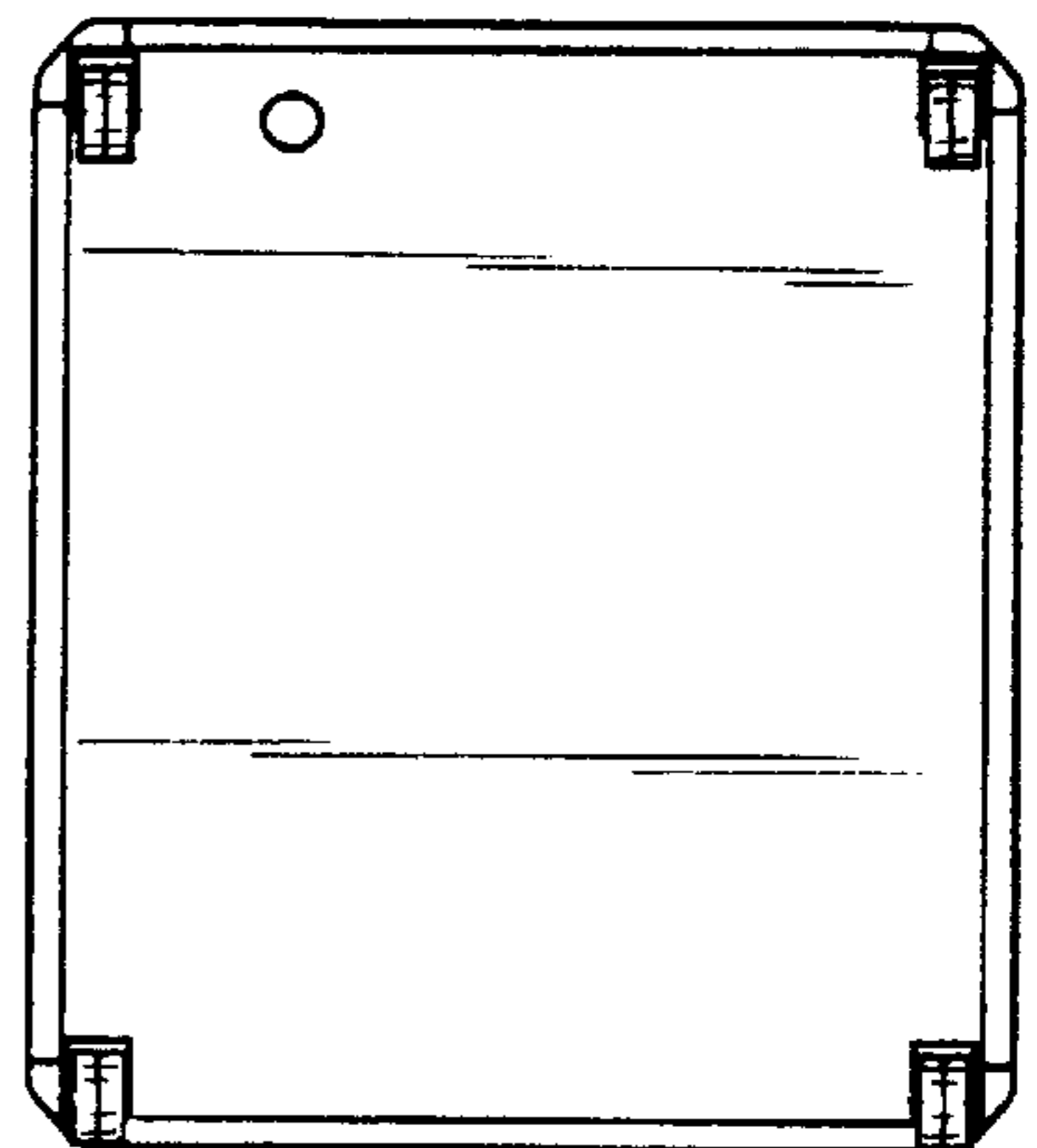

Fig. 6



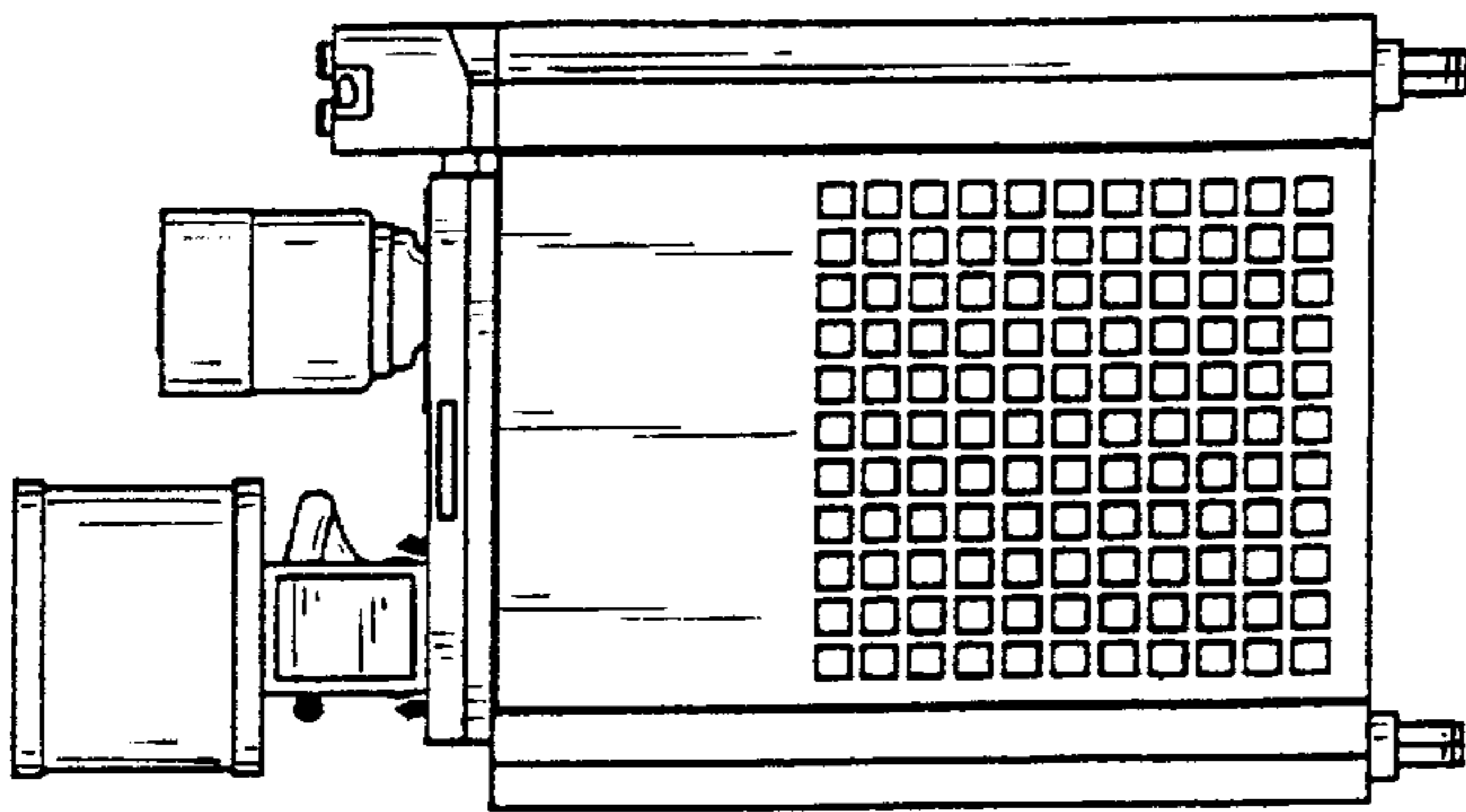

Fig. 7

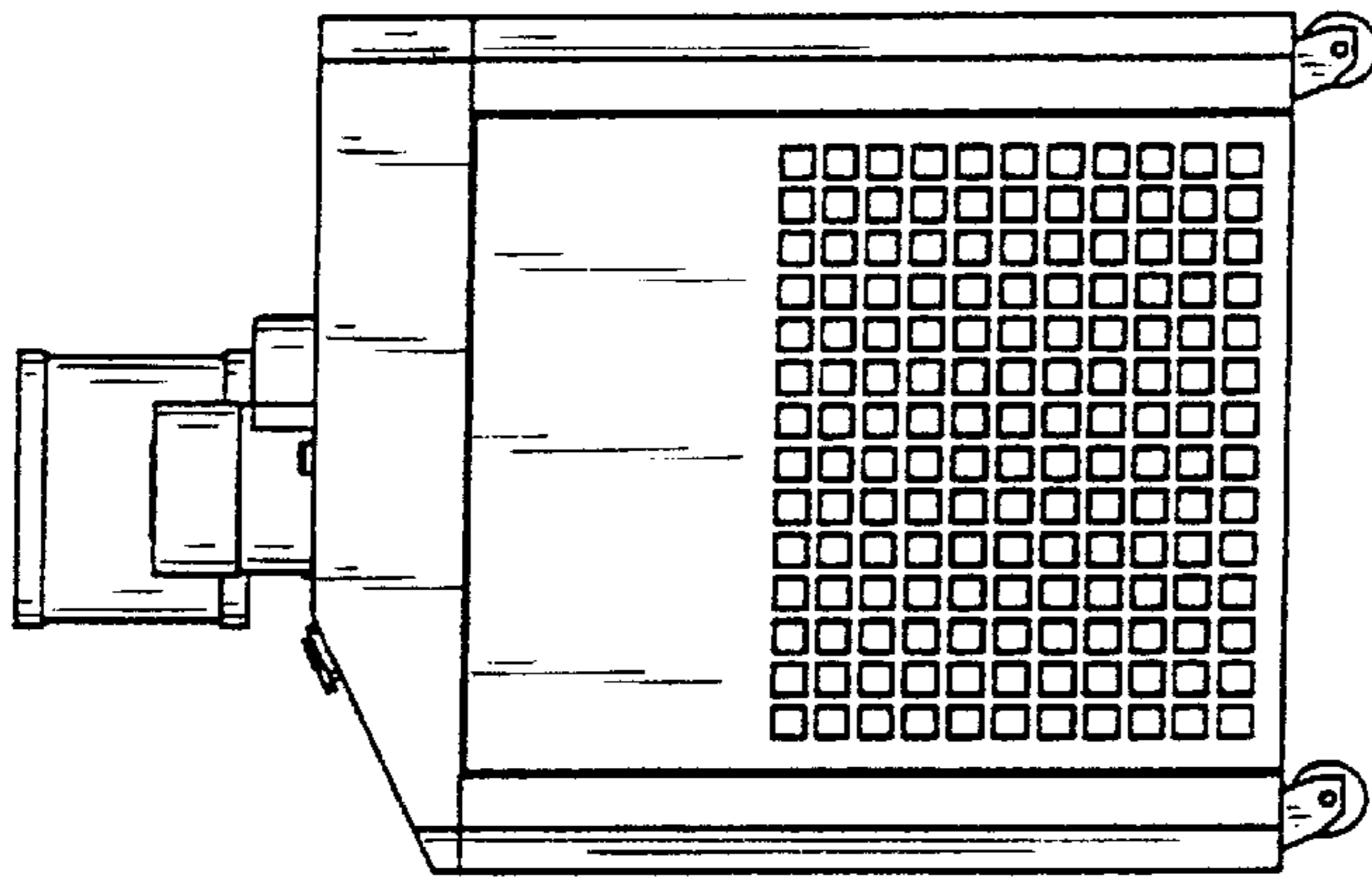

Fig. 8

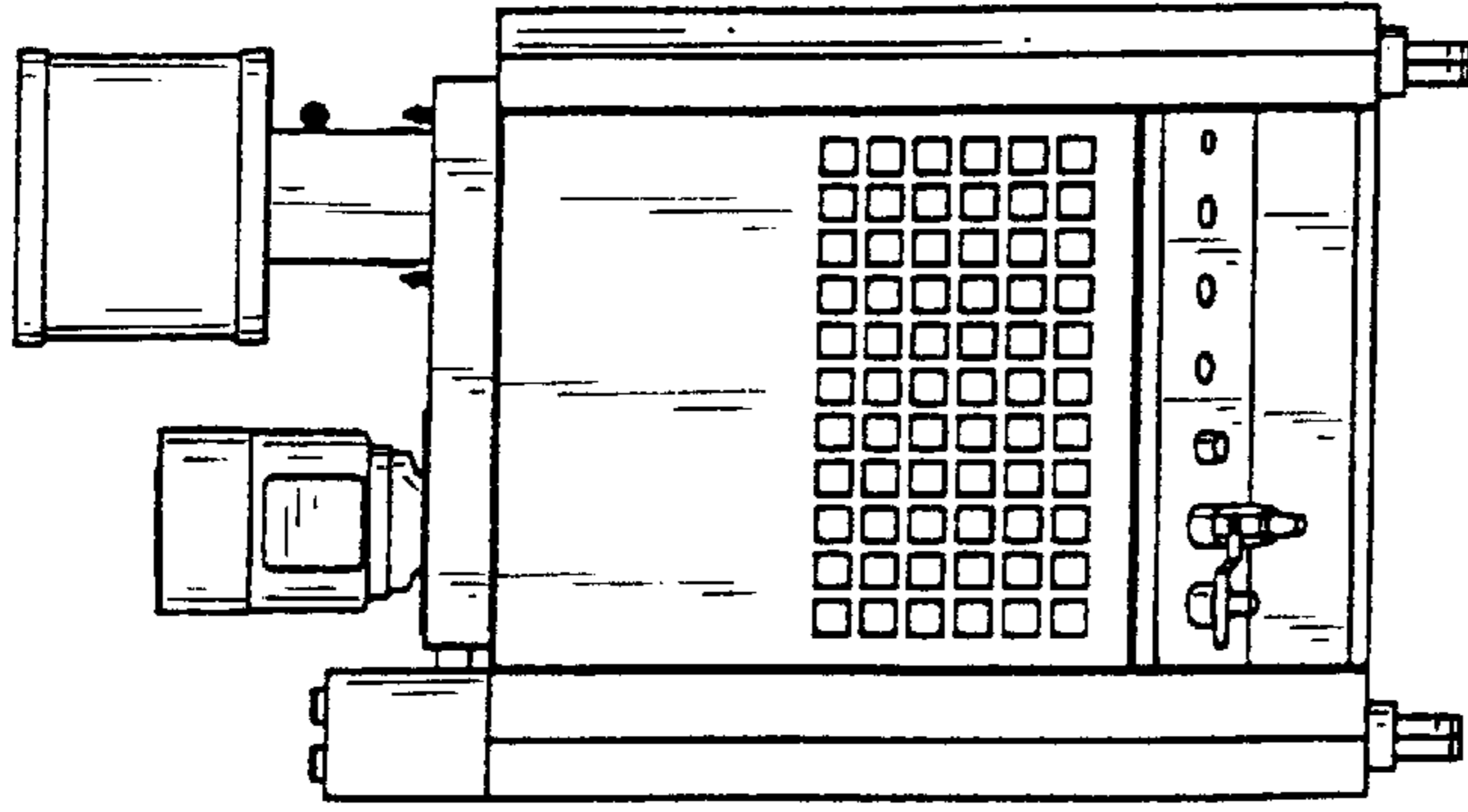

Fig. 9

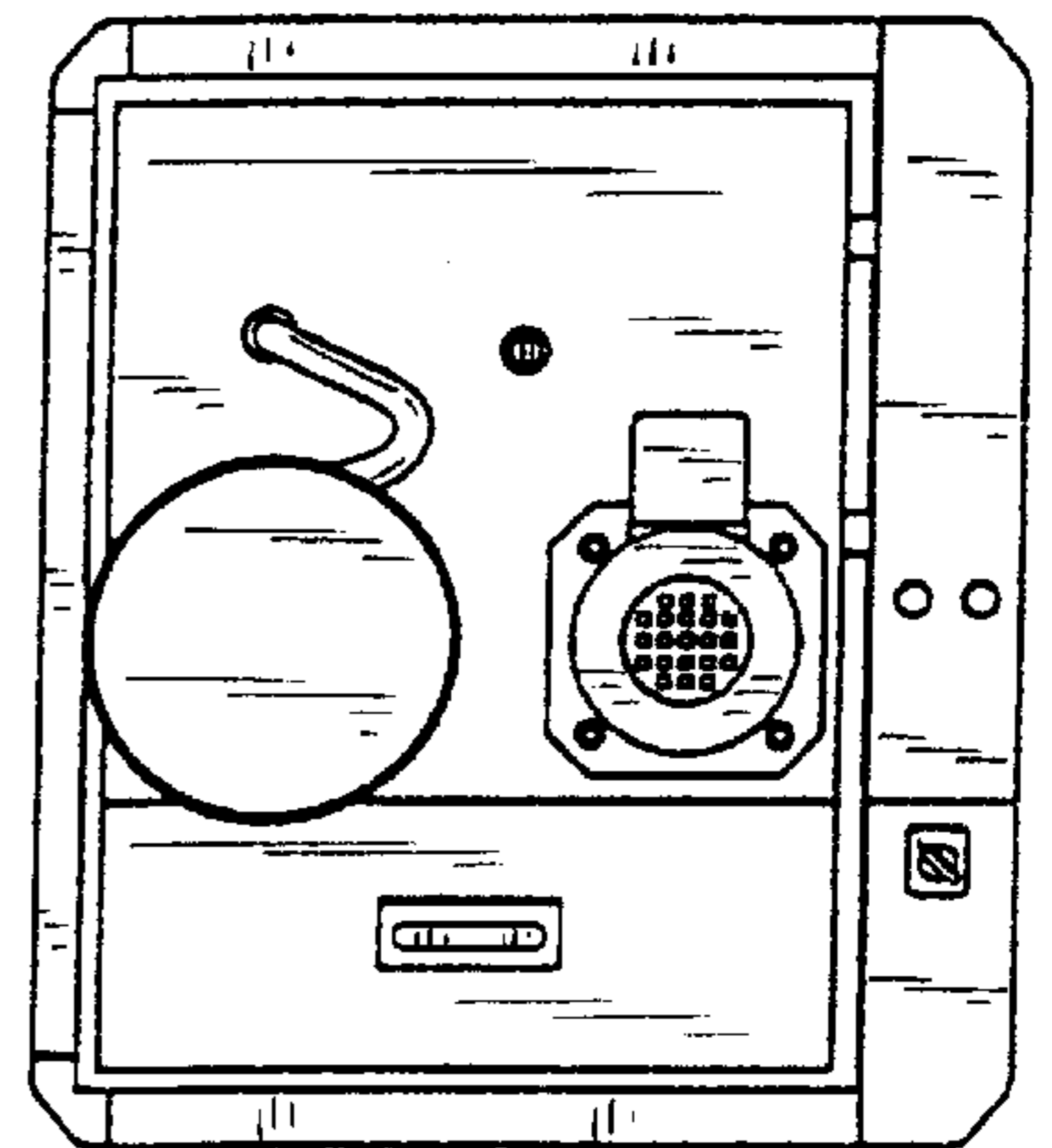

Fig. 10

Fig. 11

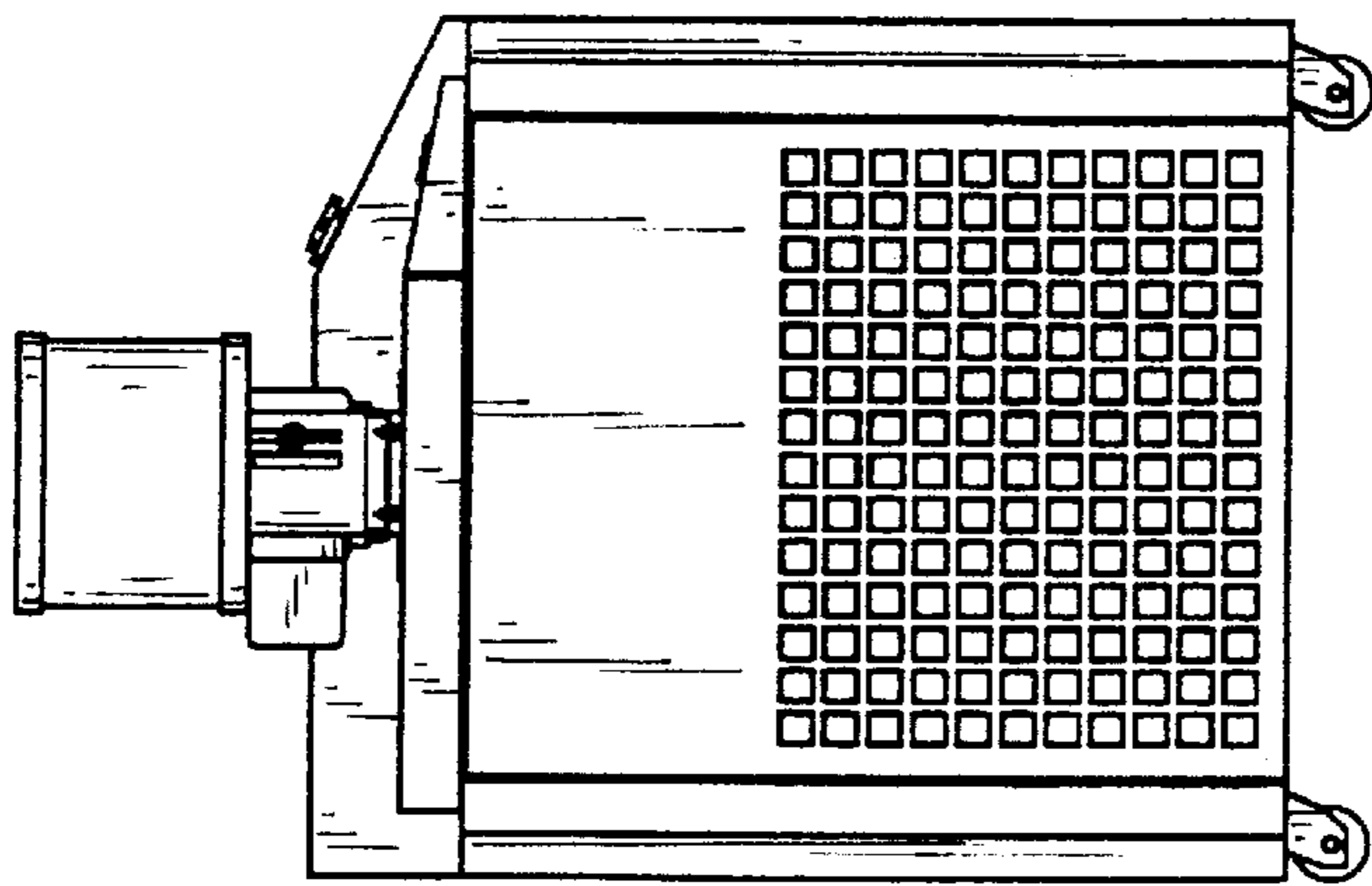
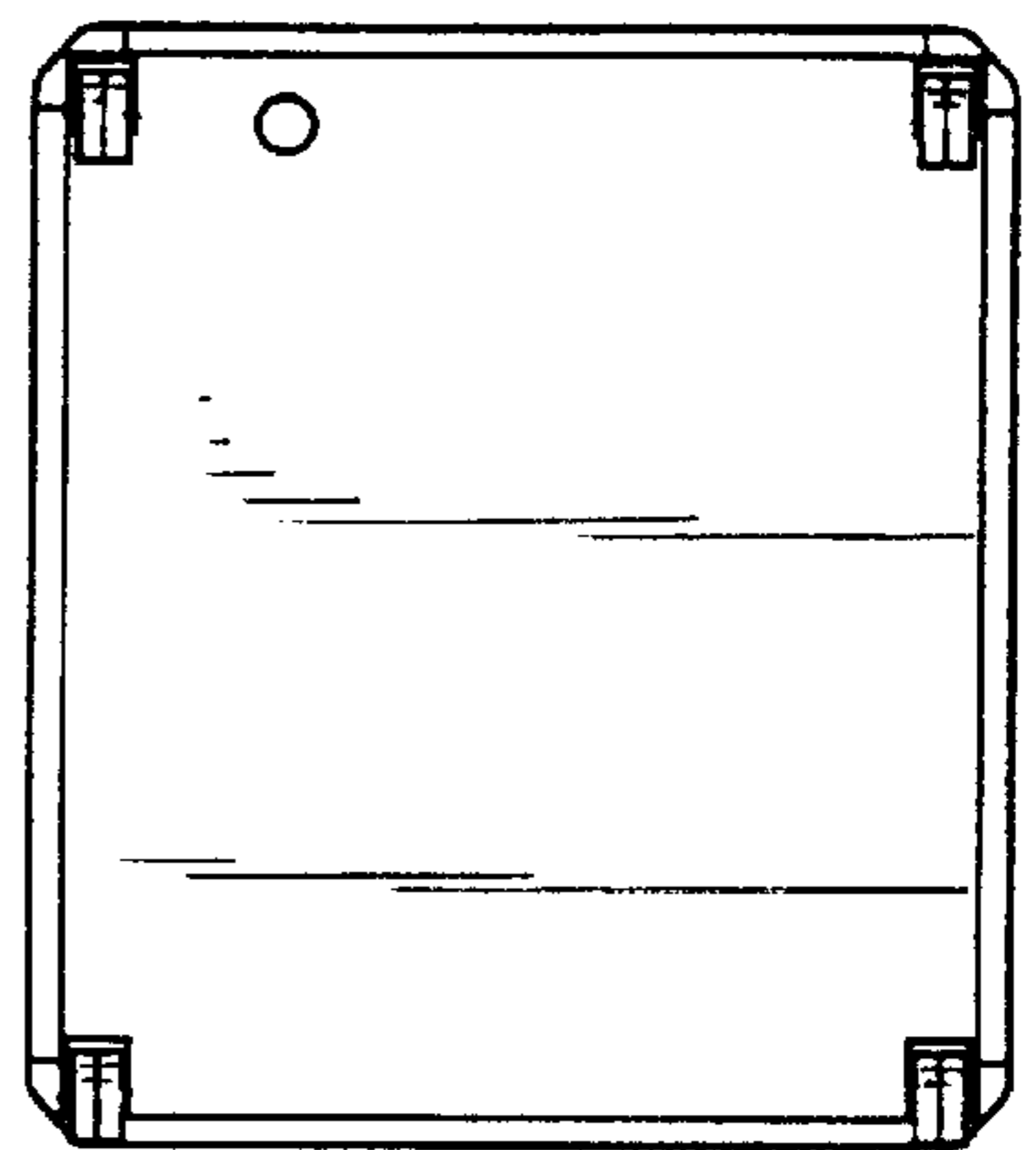

Fig. 12



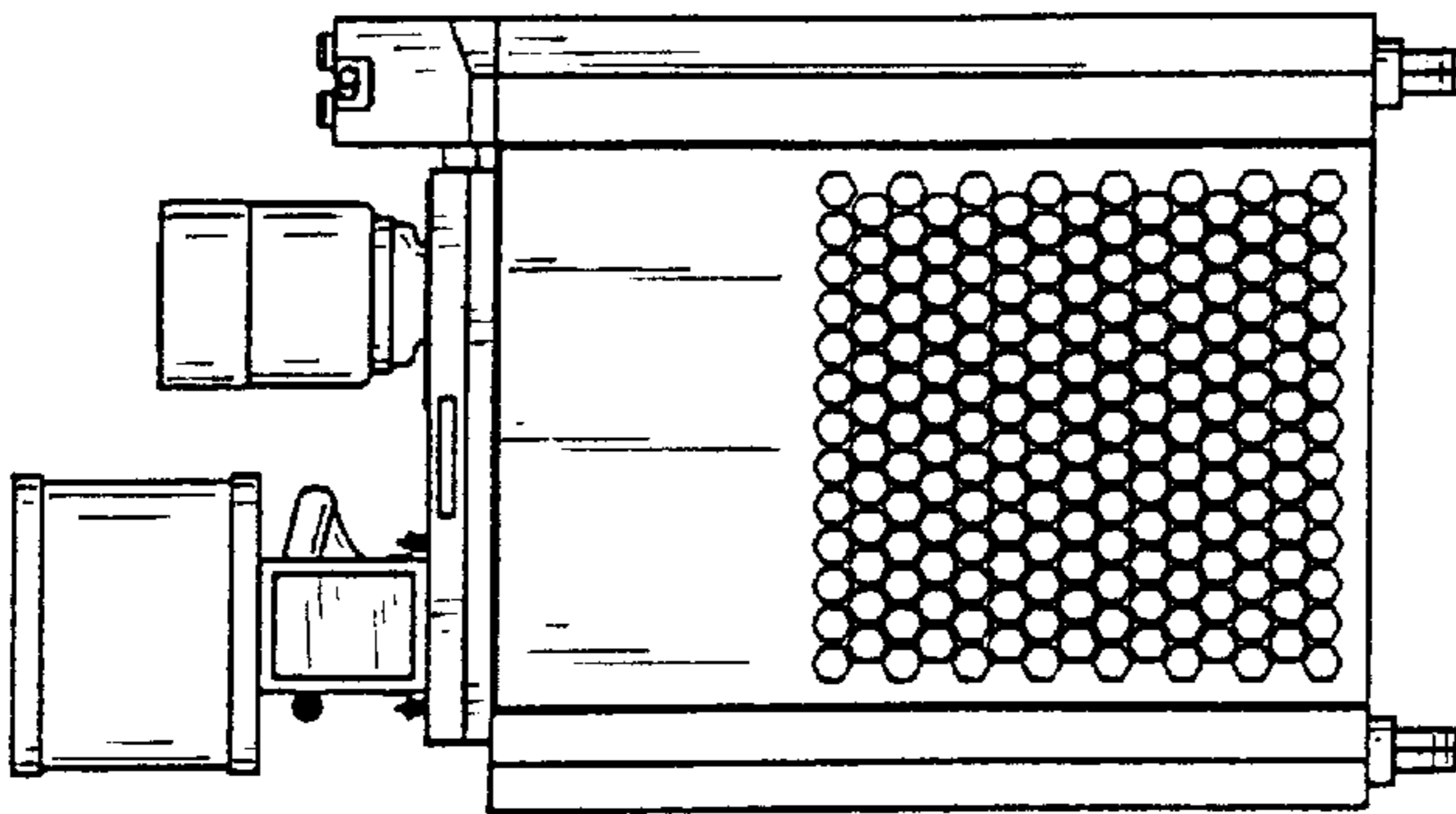

Fig. 13

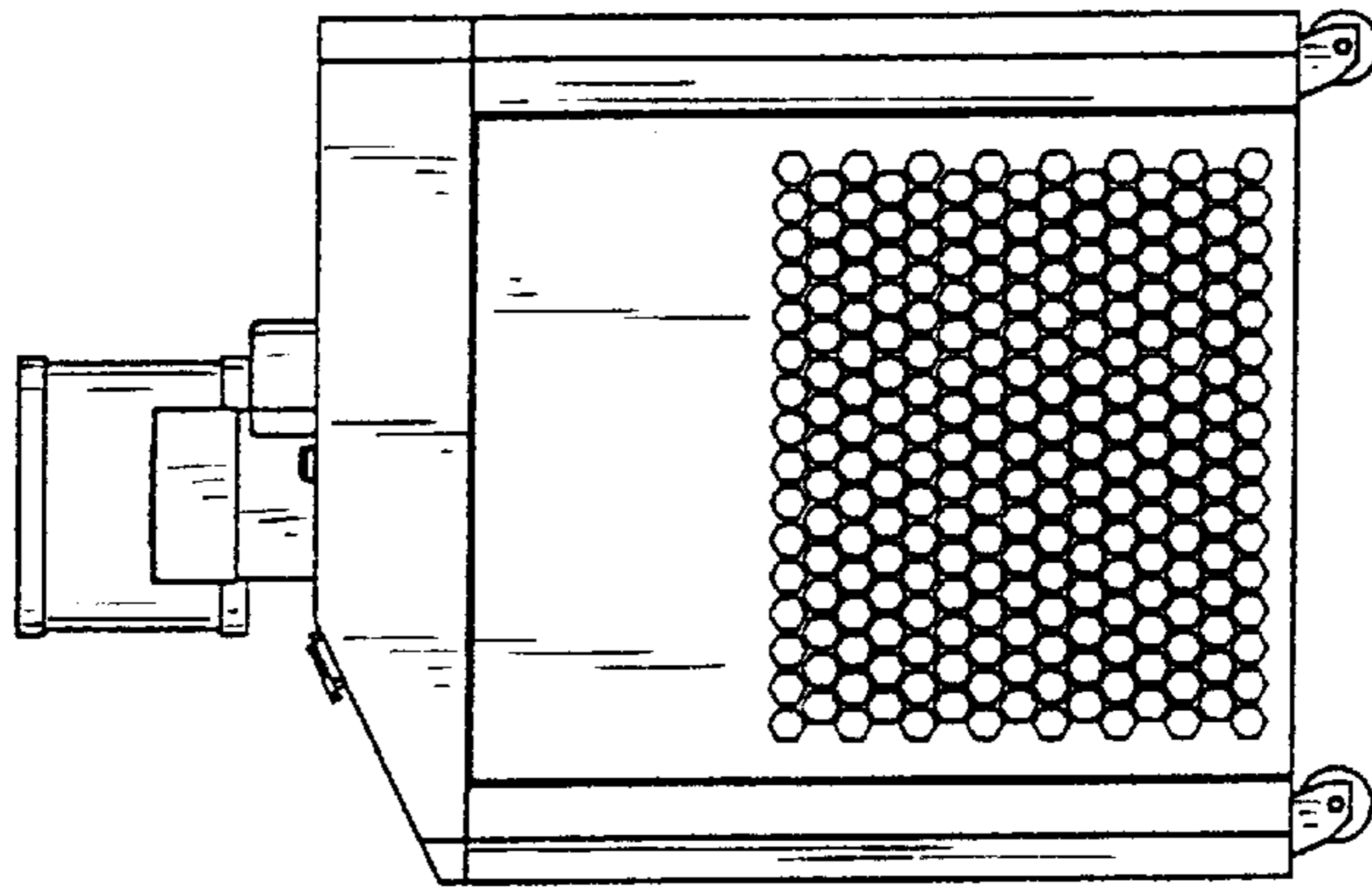

Fig. 14

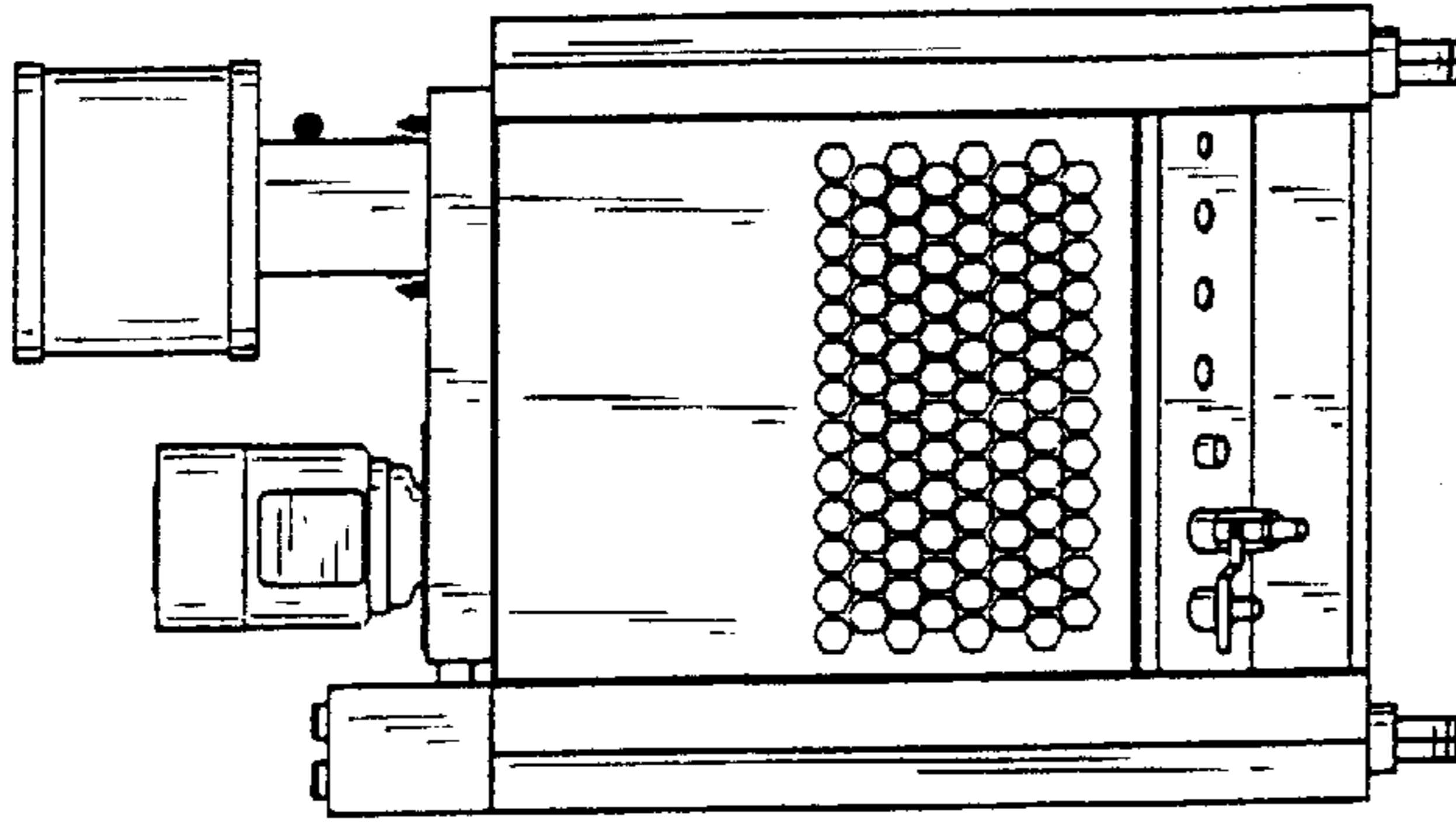

Fig. 15

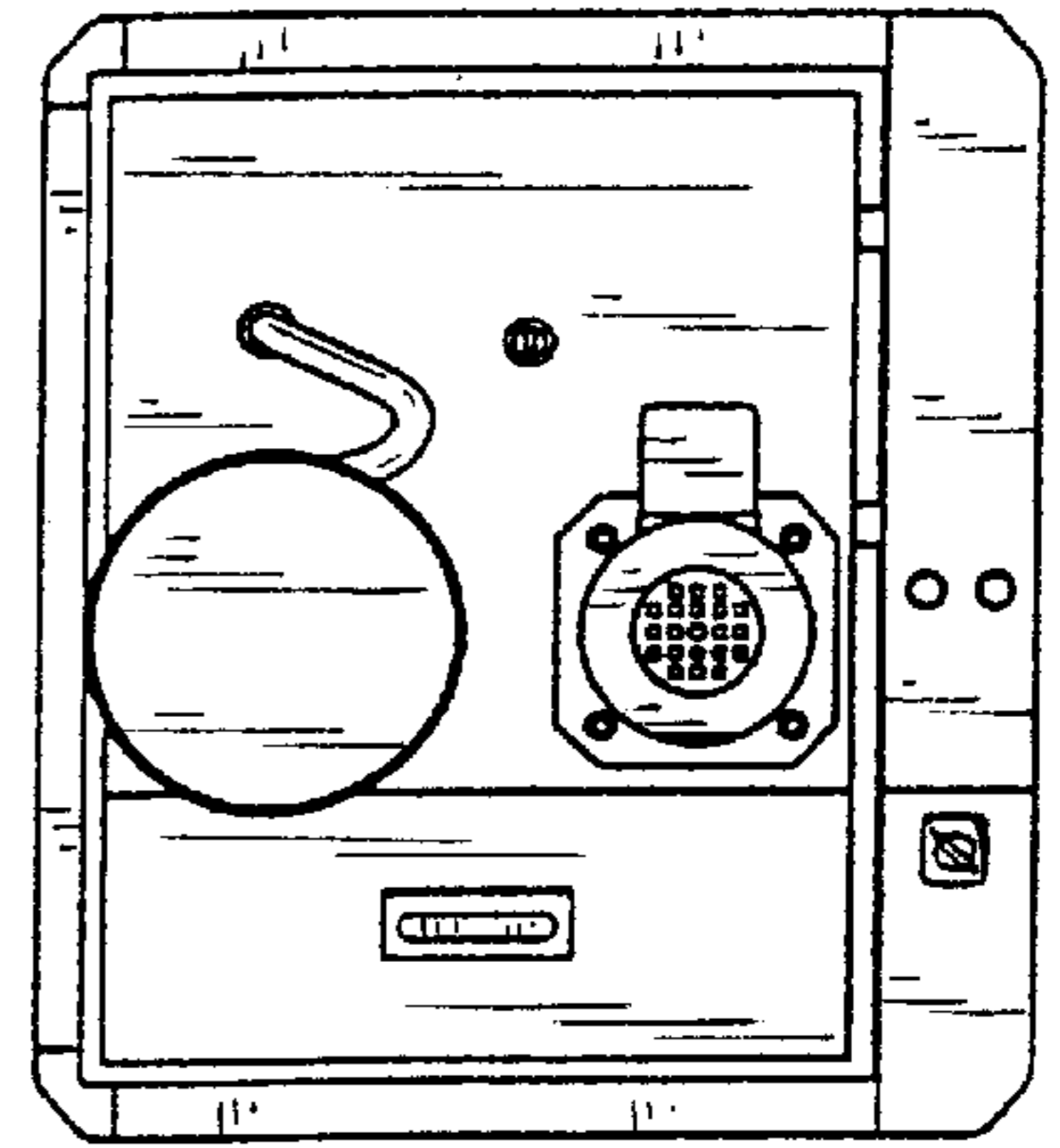

Fig. 16

Fig. 17

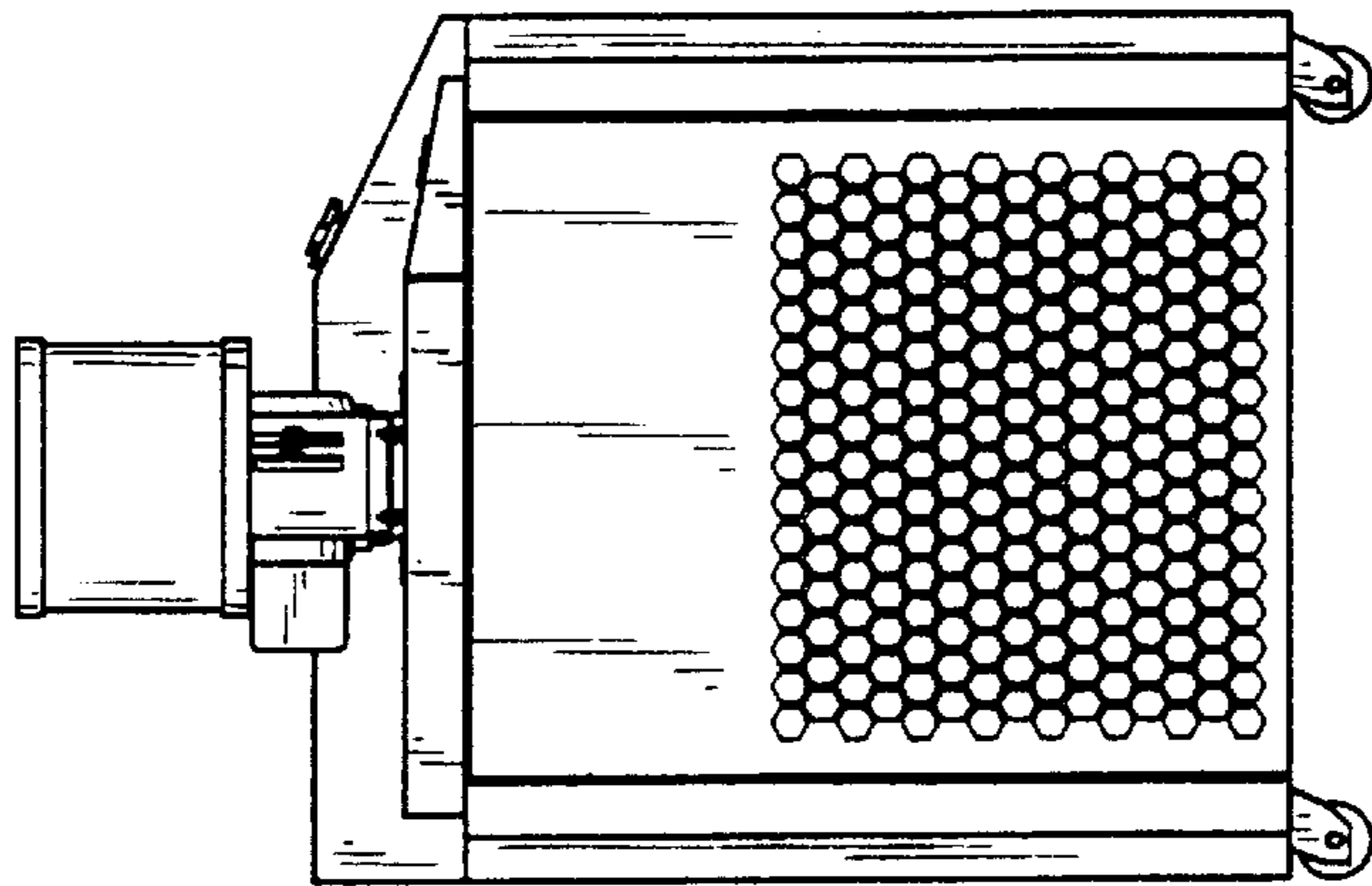

Fig. 18

