



US00D434416S

United States Patent [19] Goto

[11] **Patent Number: Des. 434,416**

[45] **Date of Patent: ** Nov. 28, 2000**

[54] **COMPUTER MOUSE**

Attorney, Agent, or Firm—Rader, Fishman & Grauer

[75] Inventor: **Teiyu Goto**, Tokyo, Japan

[57] **CLAIM**

[73] Assignee: **Sony Corporation**, Japan

The ornamental design for a computer mouse, as shown and described.

[**] Term: **14 Years**

[21] Appl. No.: **29/100,698**

DESCRIPTION

[22] Filed: **Feb. 16, 1999**

FIG. 1 is a perspective view of a first embodiment of a computer mouse showing my new design;

[51] **LOC (7) Cl.** **14-02**

[52] **U.S. Cl.** **D14/408**

FIG. 2 is a top plan view thereof;

[58] **Field of Search** D14/114, 117.1–117.9;
D13/158; D21/324–33; 200/5 R, 5 A, 6 R,
6 A; 74/471; 273/148 B; 345/156–67; 463/36–39

FIG. 3 is a left side elevational view thereof;

FIG. 4 is a front elevational view thereof;

[56] **References Cited**

U.S. PATENT DOCUMENTS

D. 349,280	8/1994	Kaneko	D14/114
D. 373,350	9/1996	Verstockt	D14/114
D. 381,968	8/1997	Edwards et al.	D14/114
D. 385,542	10/1997	Kaneko et al.	D14/114
D. 405,072	2/1999	Tso	D14/114
D. 411,189	6/1999	Liao et al.	D14/114
D. 411,190	6/1999	McMahon et al.	D14/114
D. 413,322	8/1999	Sheehan et al.	D14/117.3
D. 414,483	9/1999	Cox et al.	D14/117.3
5,157,381	10/1992	Cheng	.	

FIG. 5 is a bottom plan view thereof;

FIG. 6 is a right side elevational view thereof; and

FIG. 7 is a rear elevational view thereof.

FIG. 8 is a perspective view of a second embodiment of a computer mouse showing my new design;

FIG. 9 is a top plan view thereof;

FIG. 10 is a left side elevational view thereof;

FIG. 11 is a front elevational view thereof;

FIG. 12 is a bottom plan view thereof;

FIG. 13 is a right side elevational view thereof; and ,

FIG. 14 is a rear elevational view thereof.

OTHER PUBLICATIONS

Suntec, "Telaffy No. 16", p. 49, ("inteliMouse–DV"), Nov. 30, 1997).

Yodobashi Camera, "The Point Network No. 41", p. 45 and its portion enlarge (ASCII "Mie–Mouse"), (Jun. 19, 1998).

Primary Examiner—M. H. Tung

1 Claim, 8 Drawing Sheets

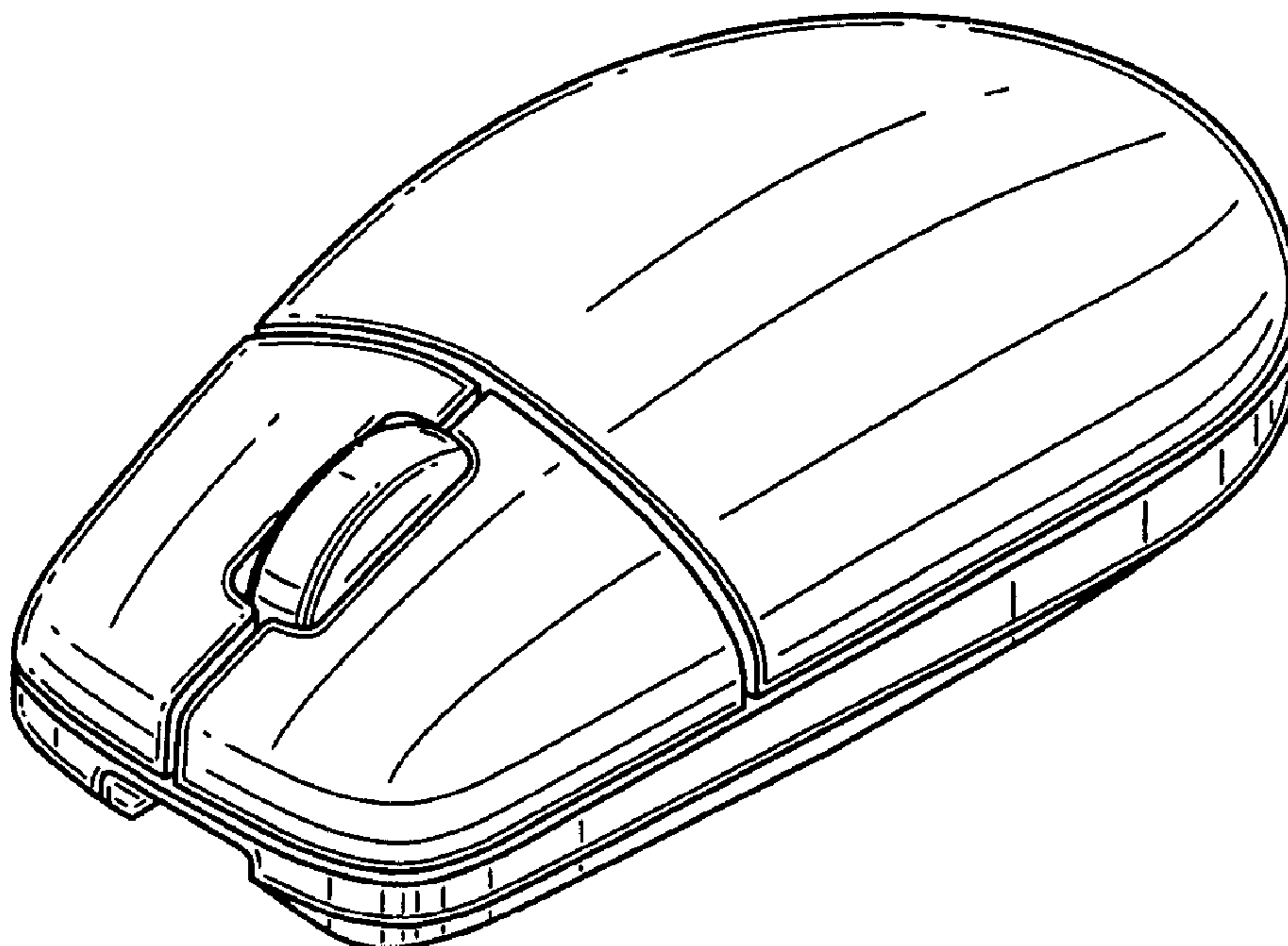

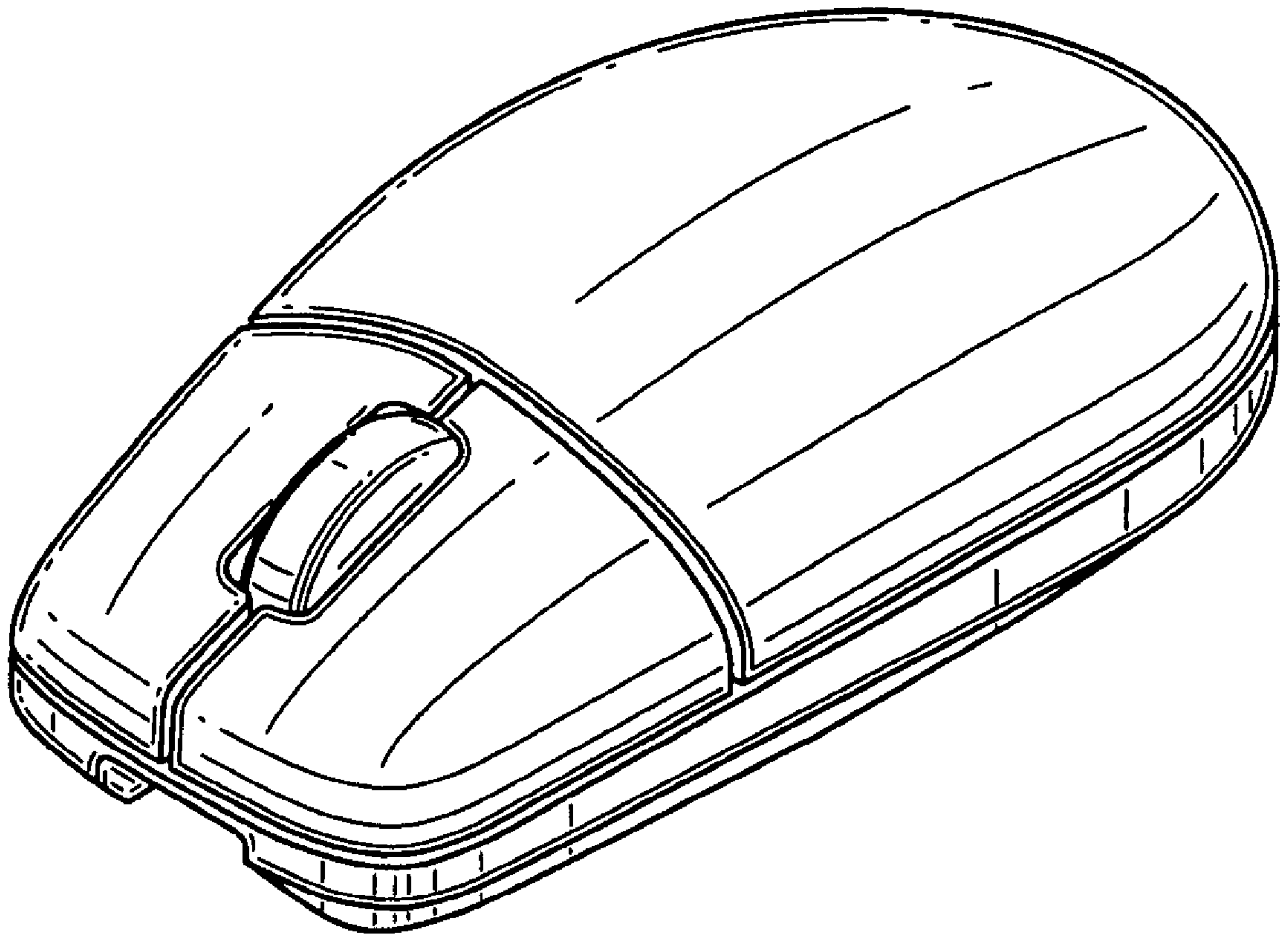

FIG. 1

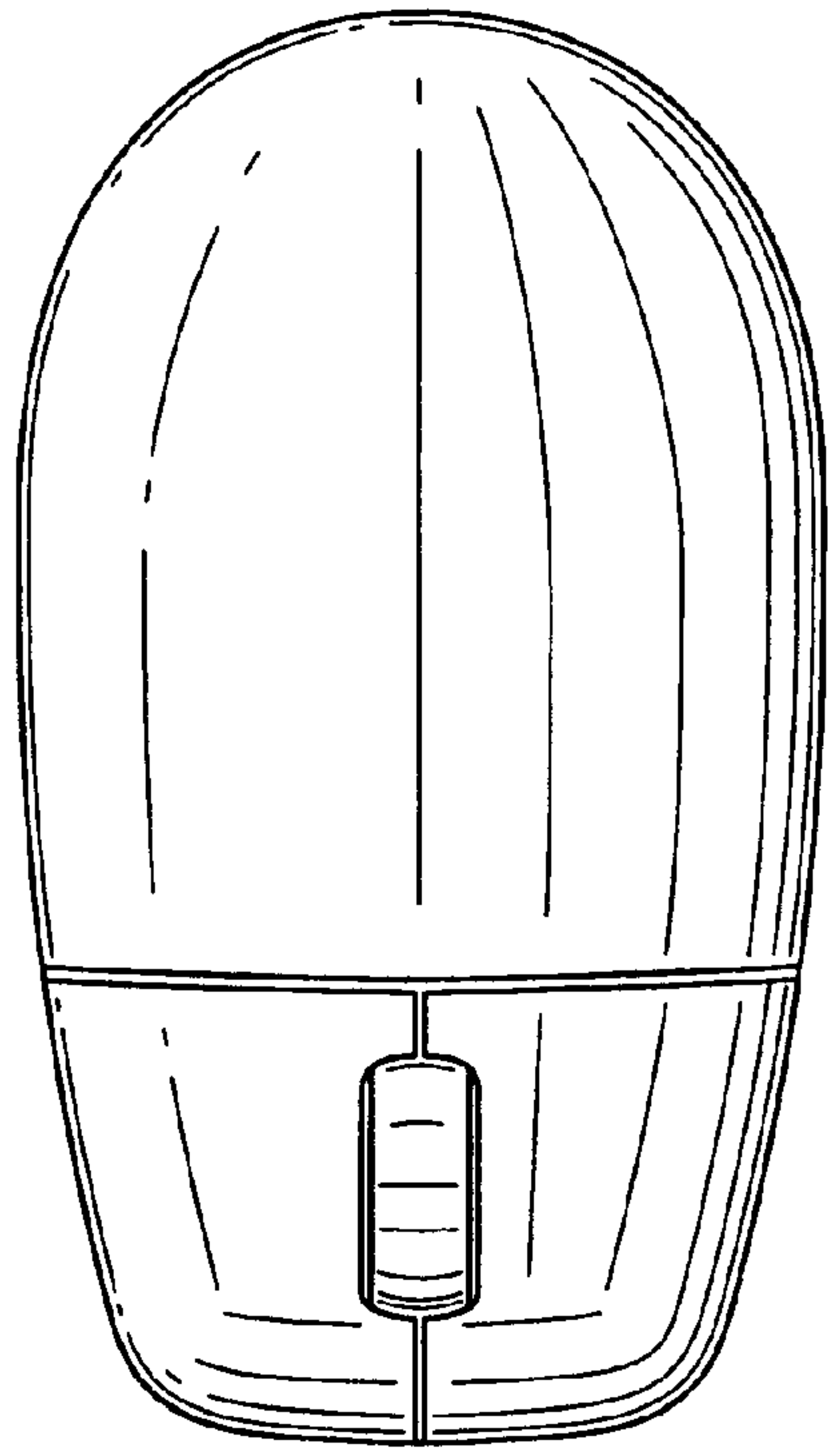

FIG. 2

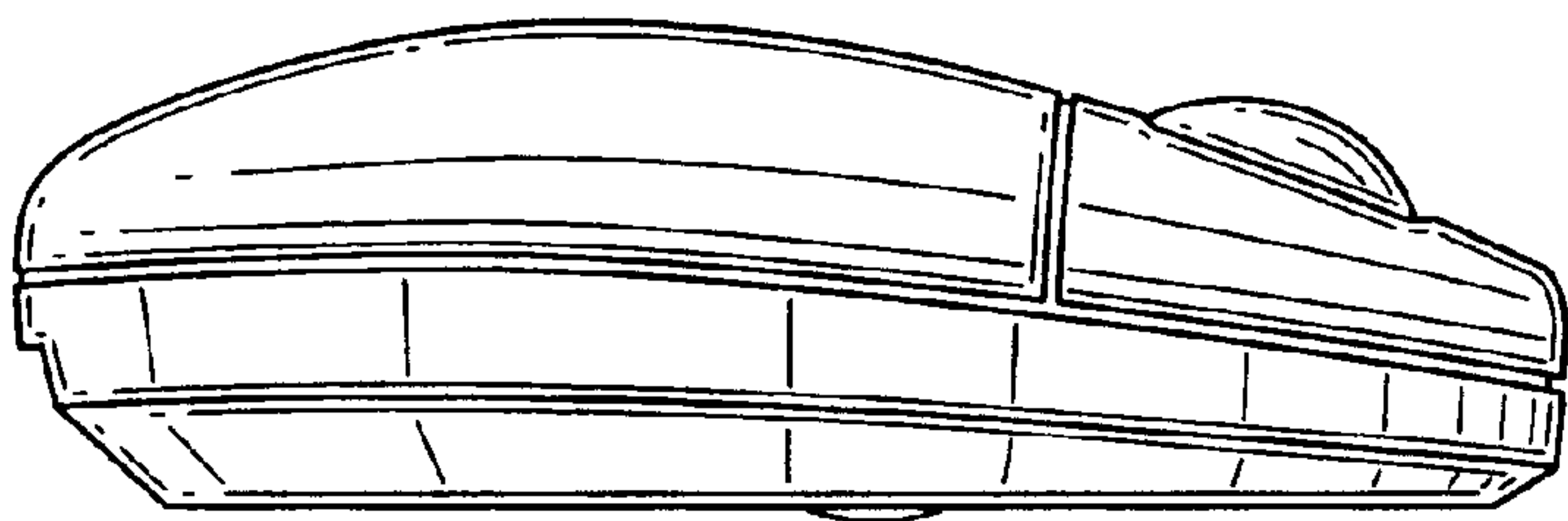

FIG. 3

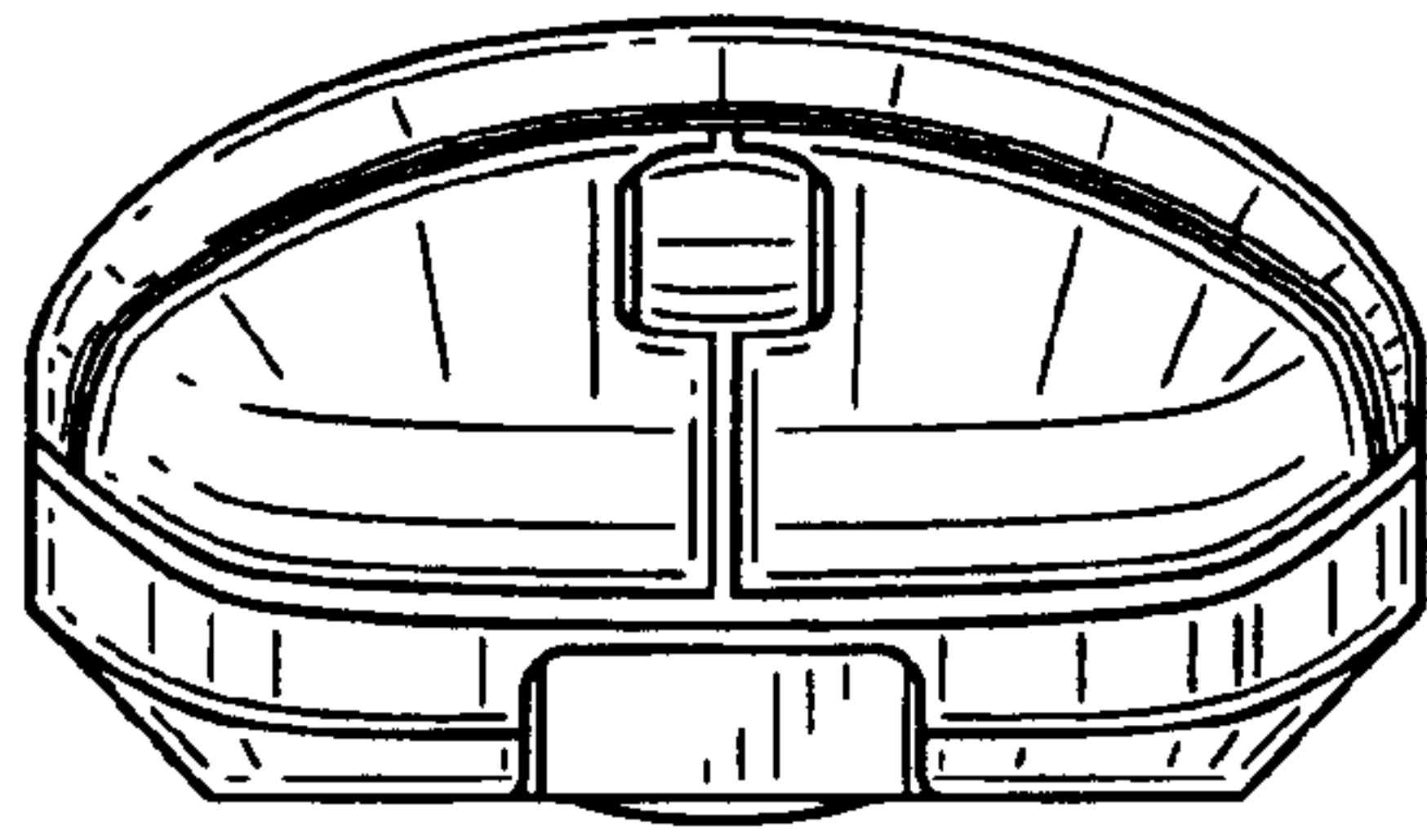

FIG. 4

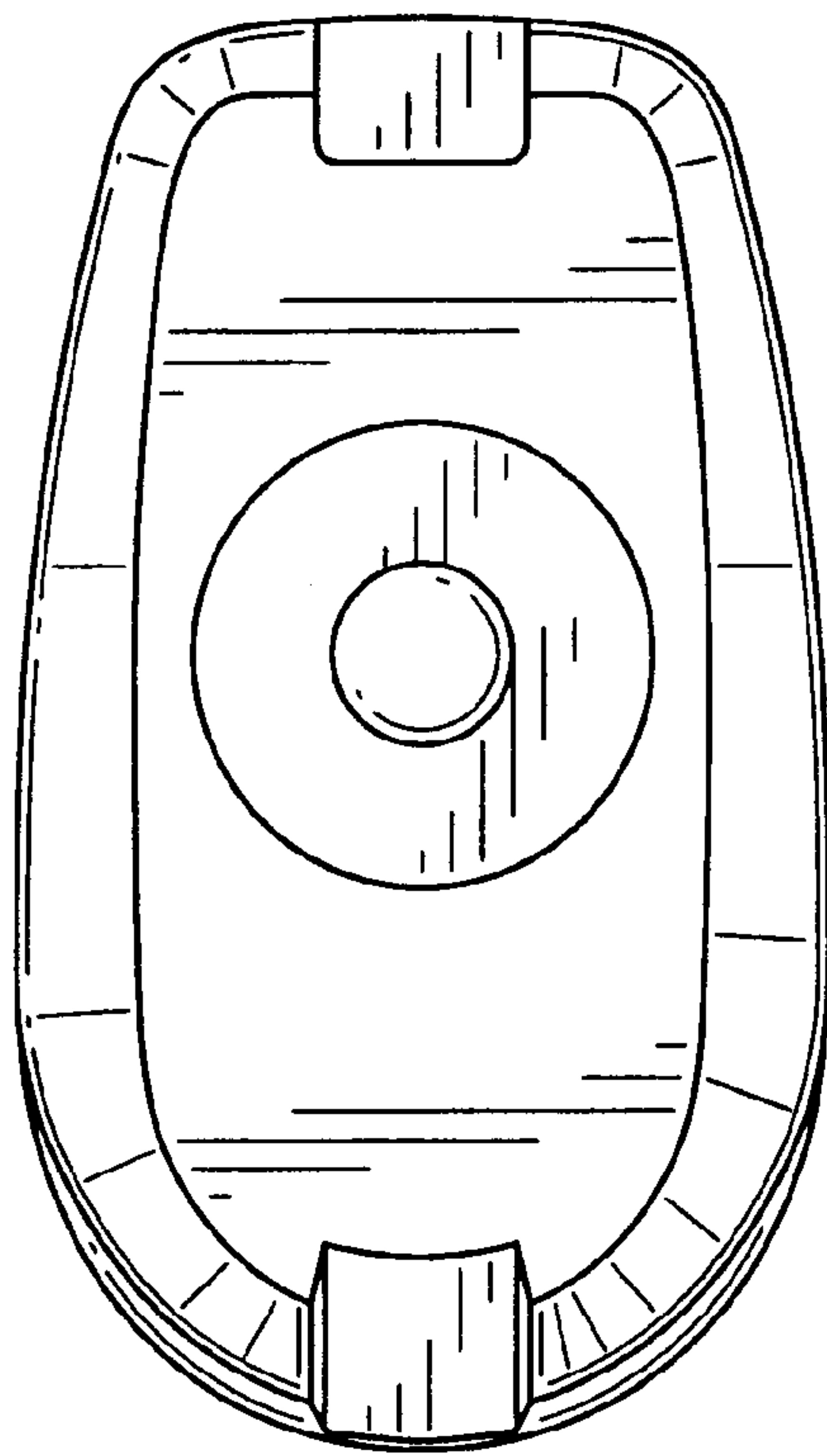

FIG. 5

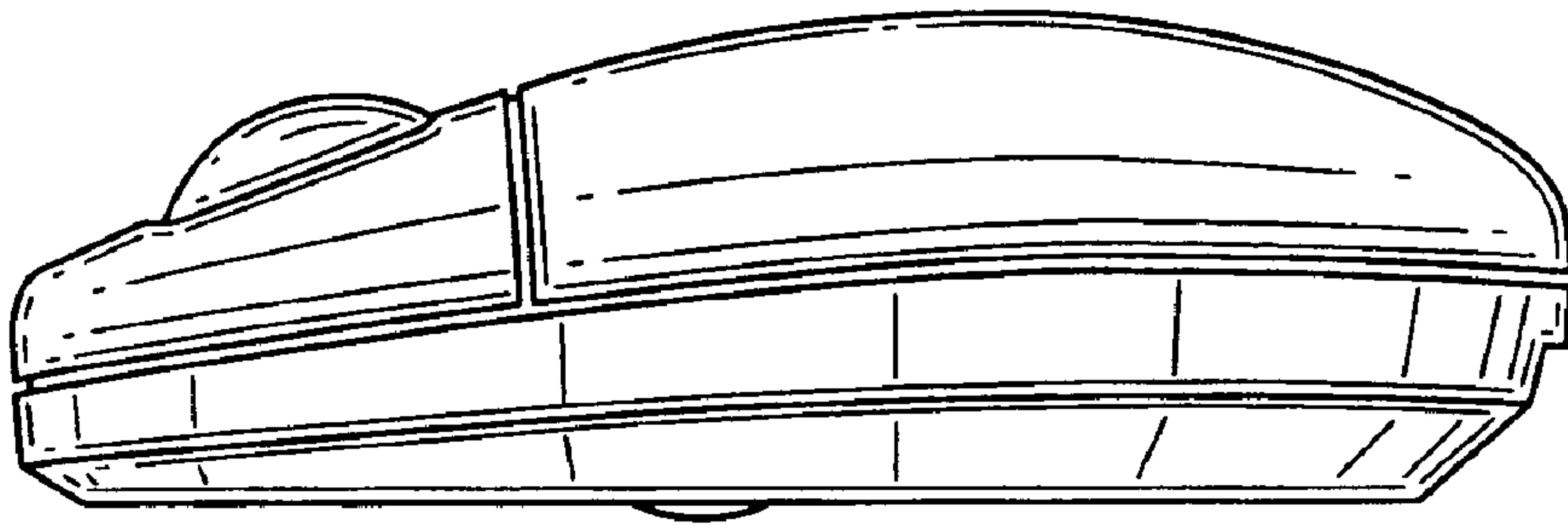

FIG. 6

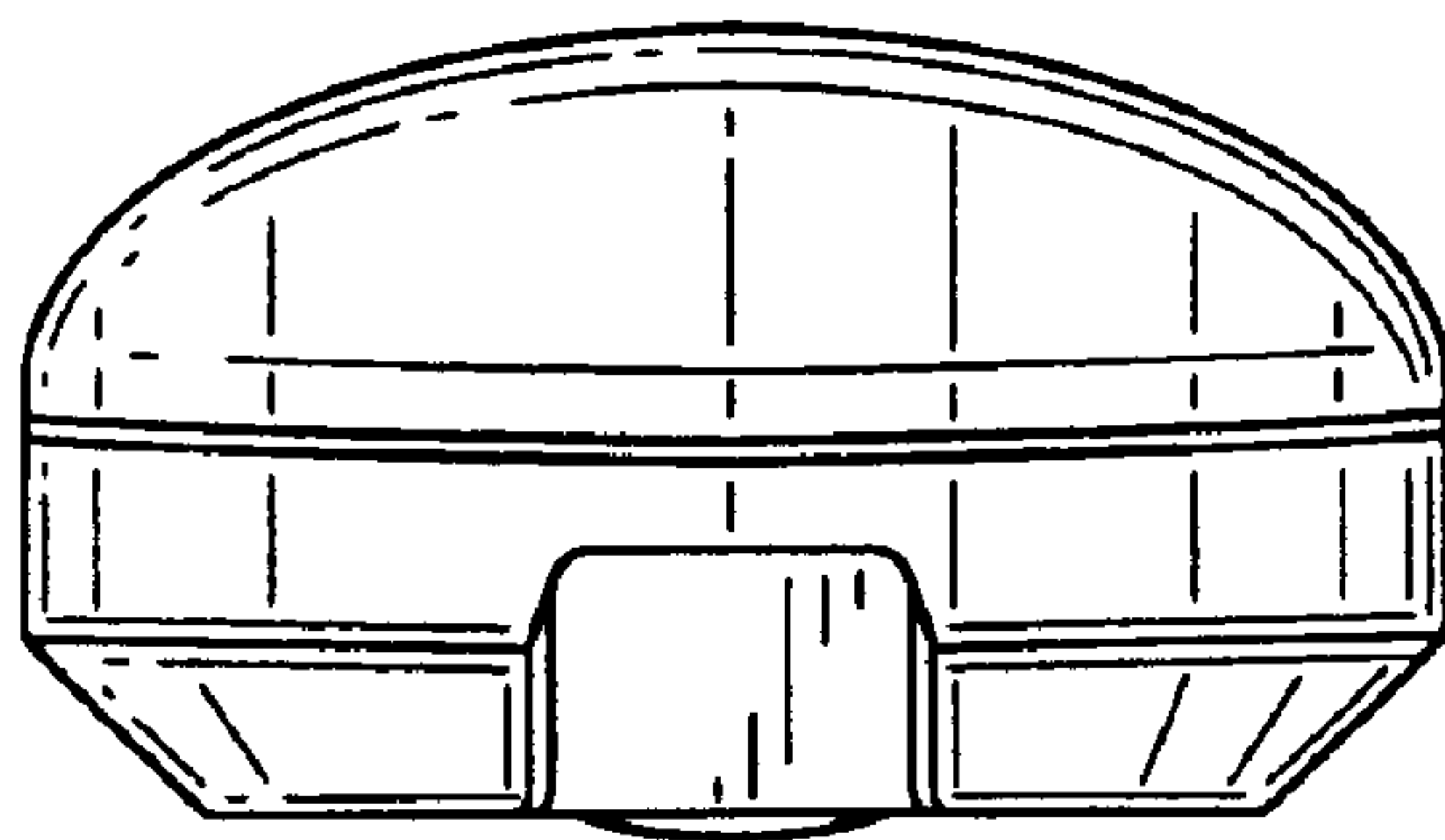

FIG. 7

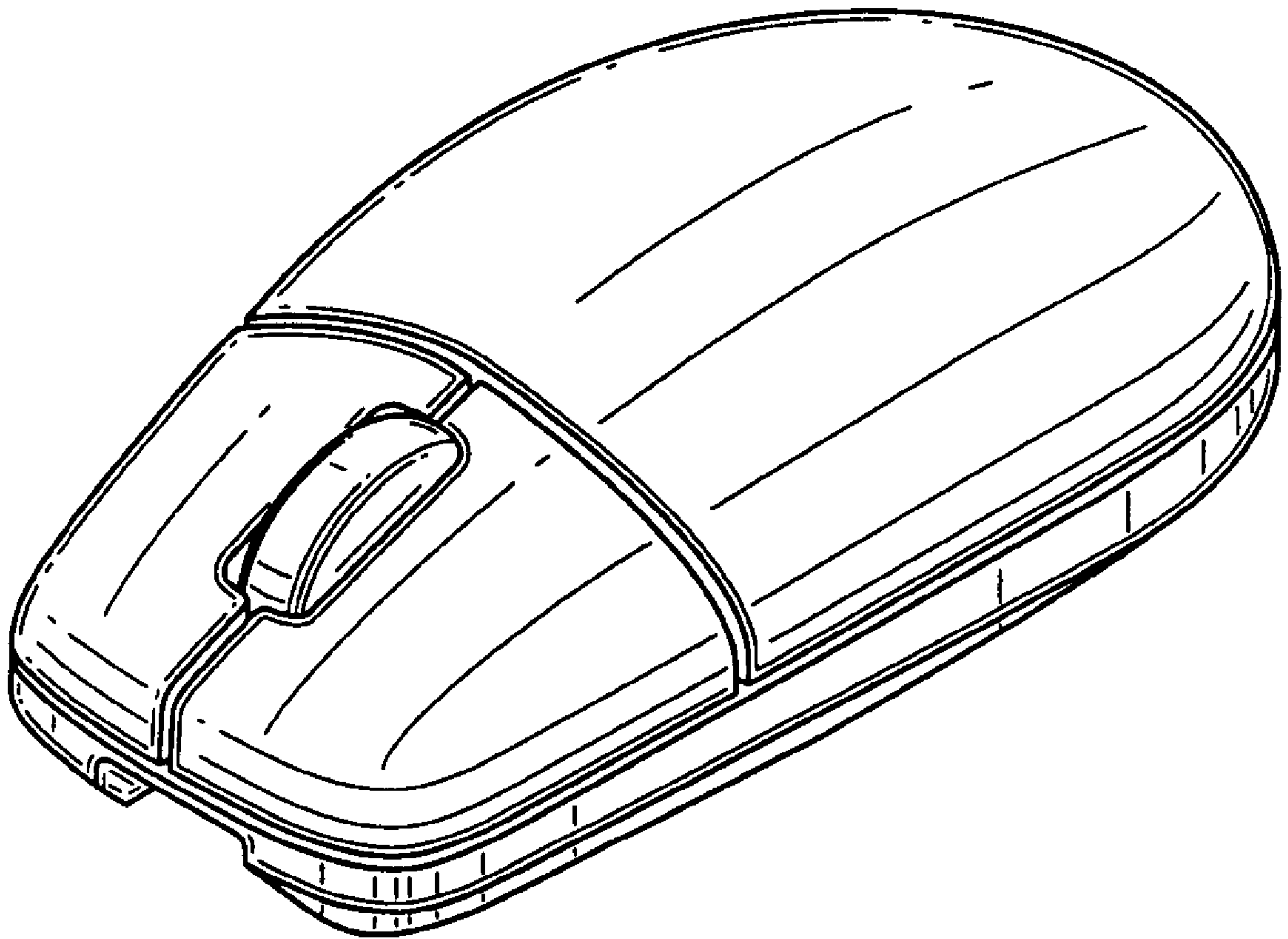

FIG. 8

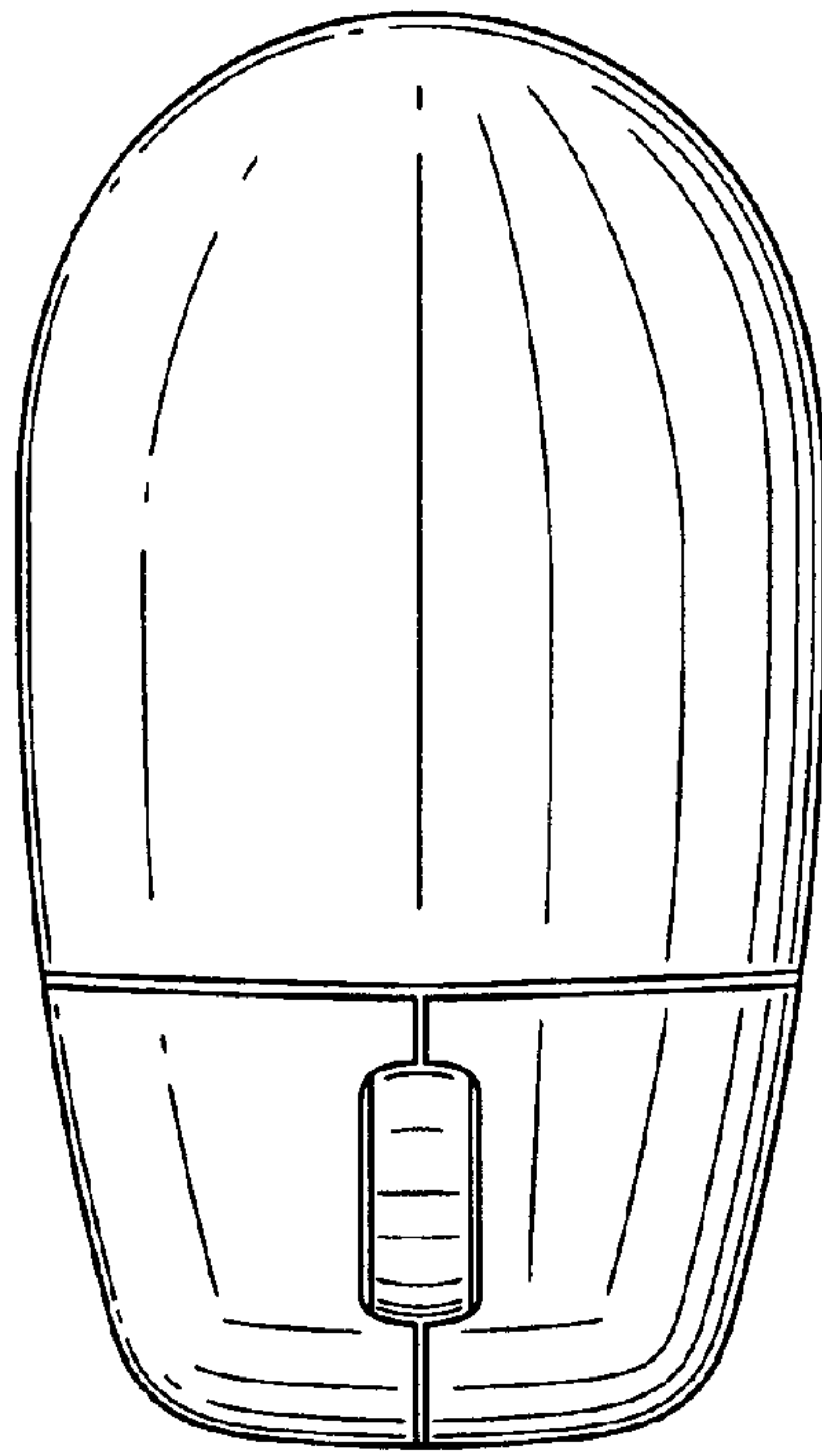

FIG. 9

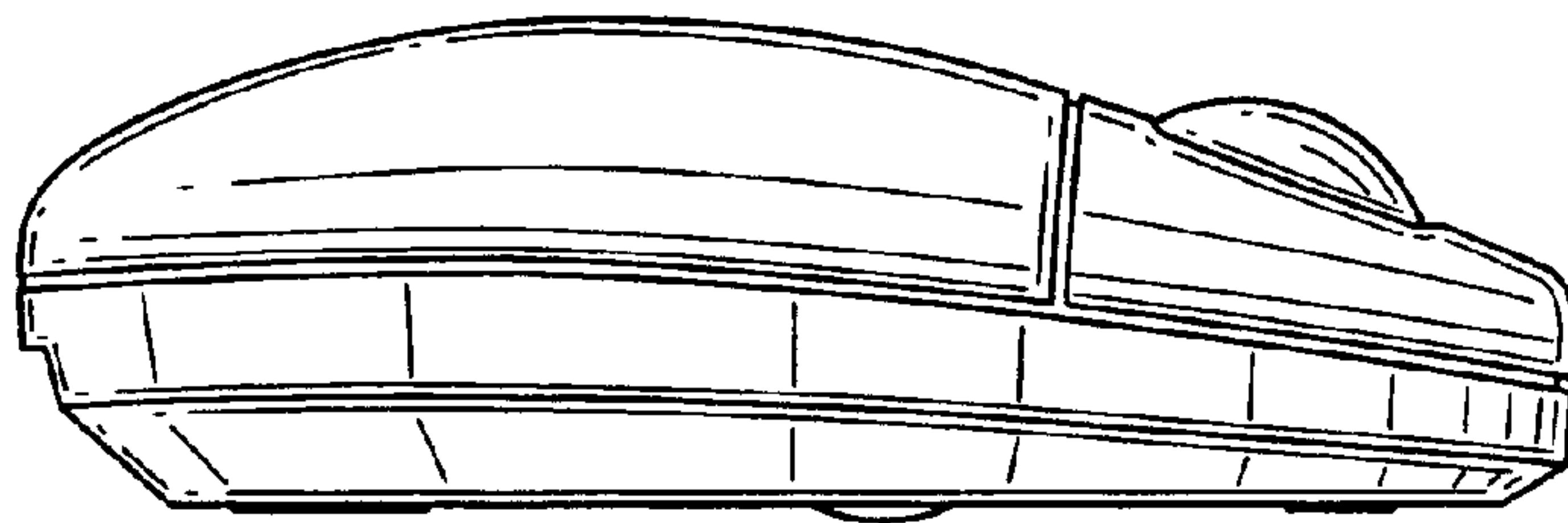

FIG. 10

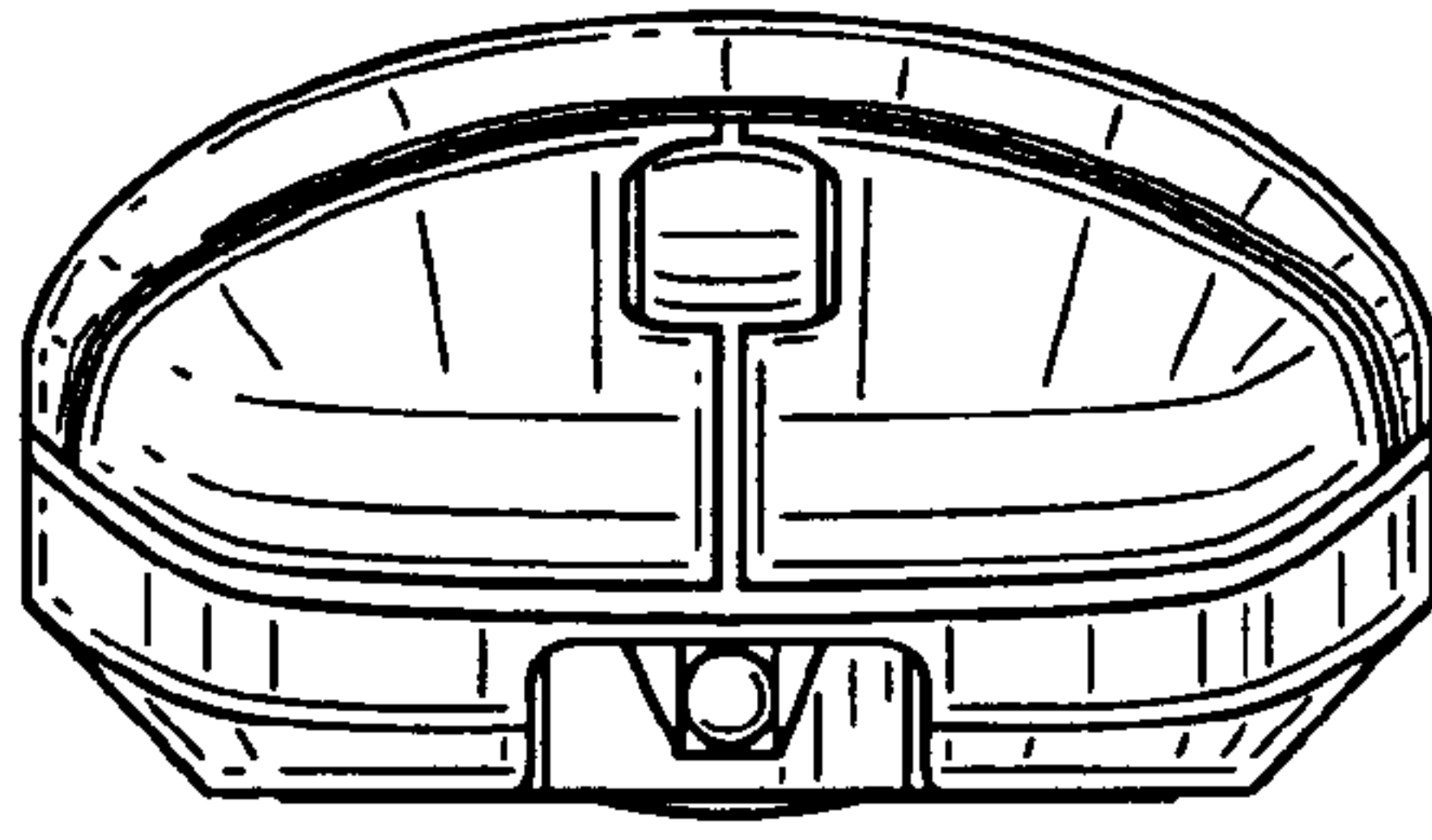

FIG. 11

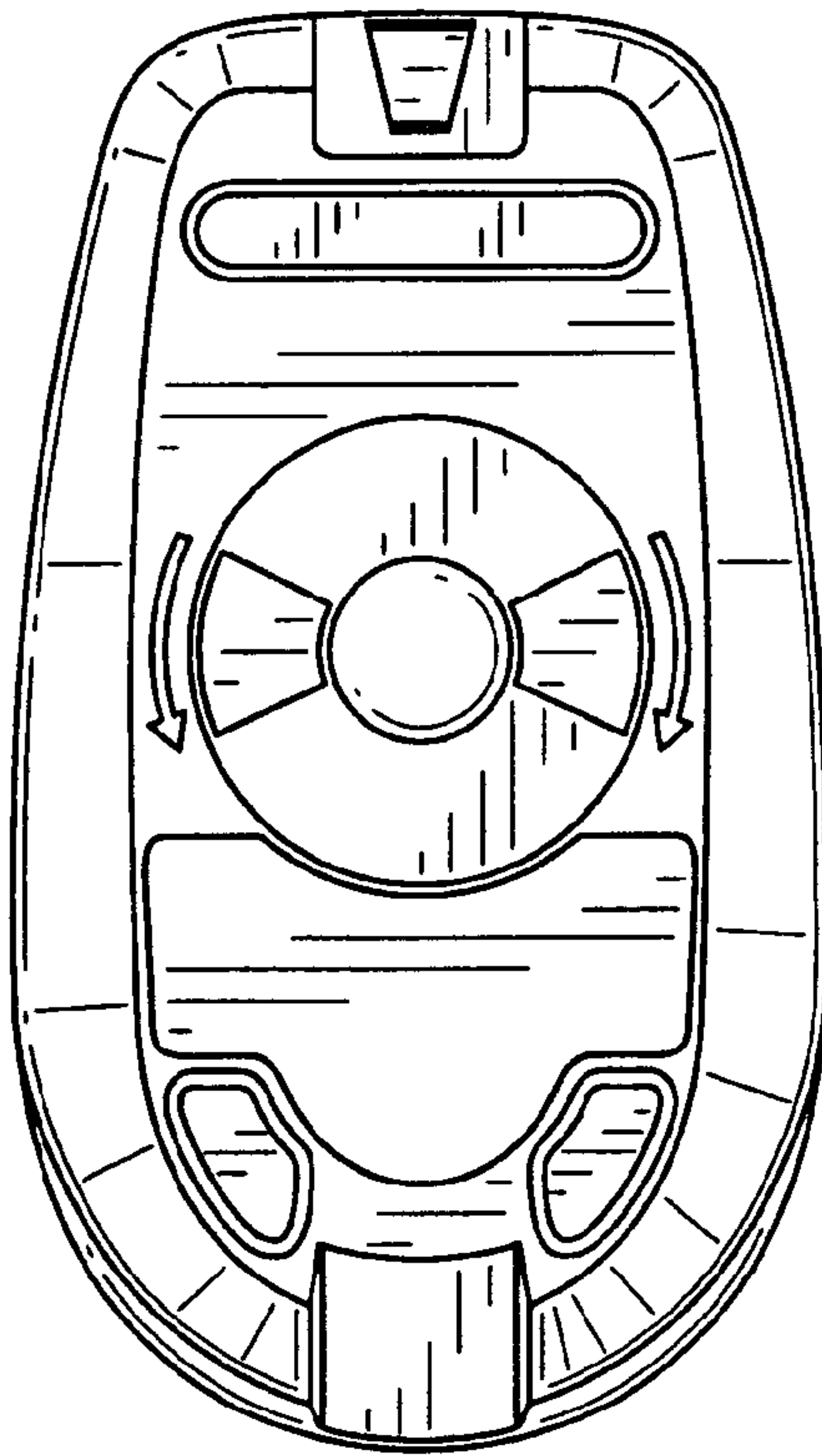

FIG. 12

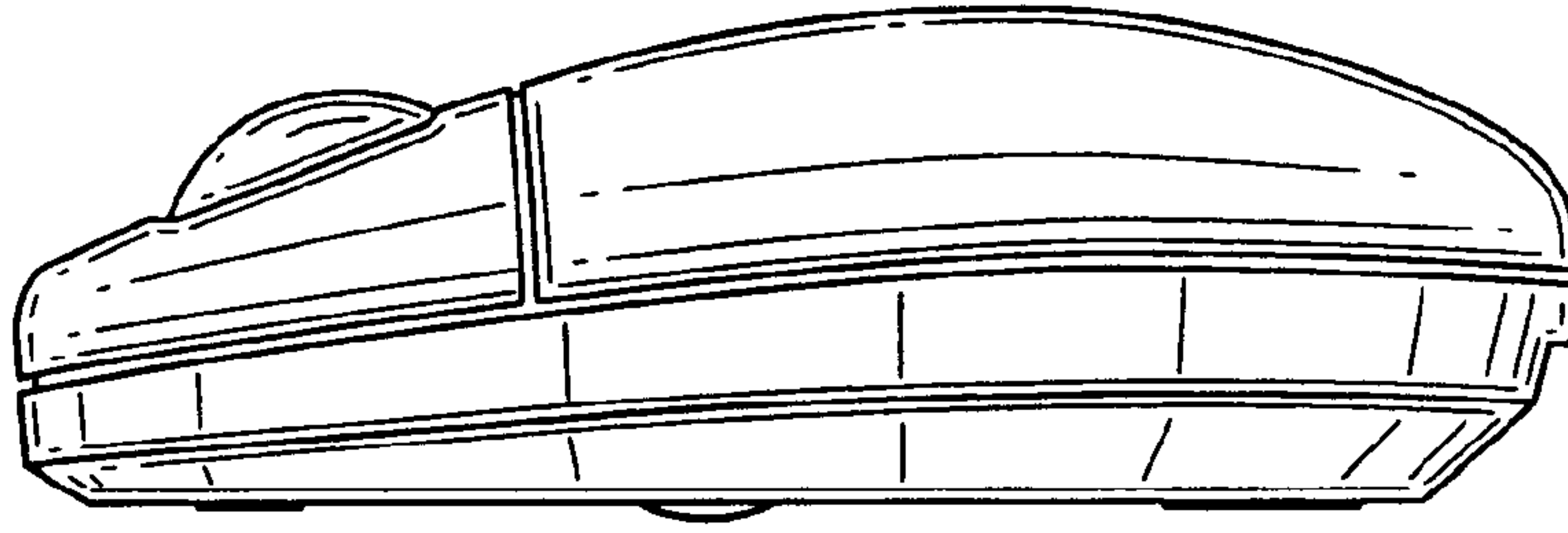

FIG. 13

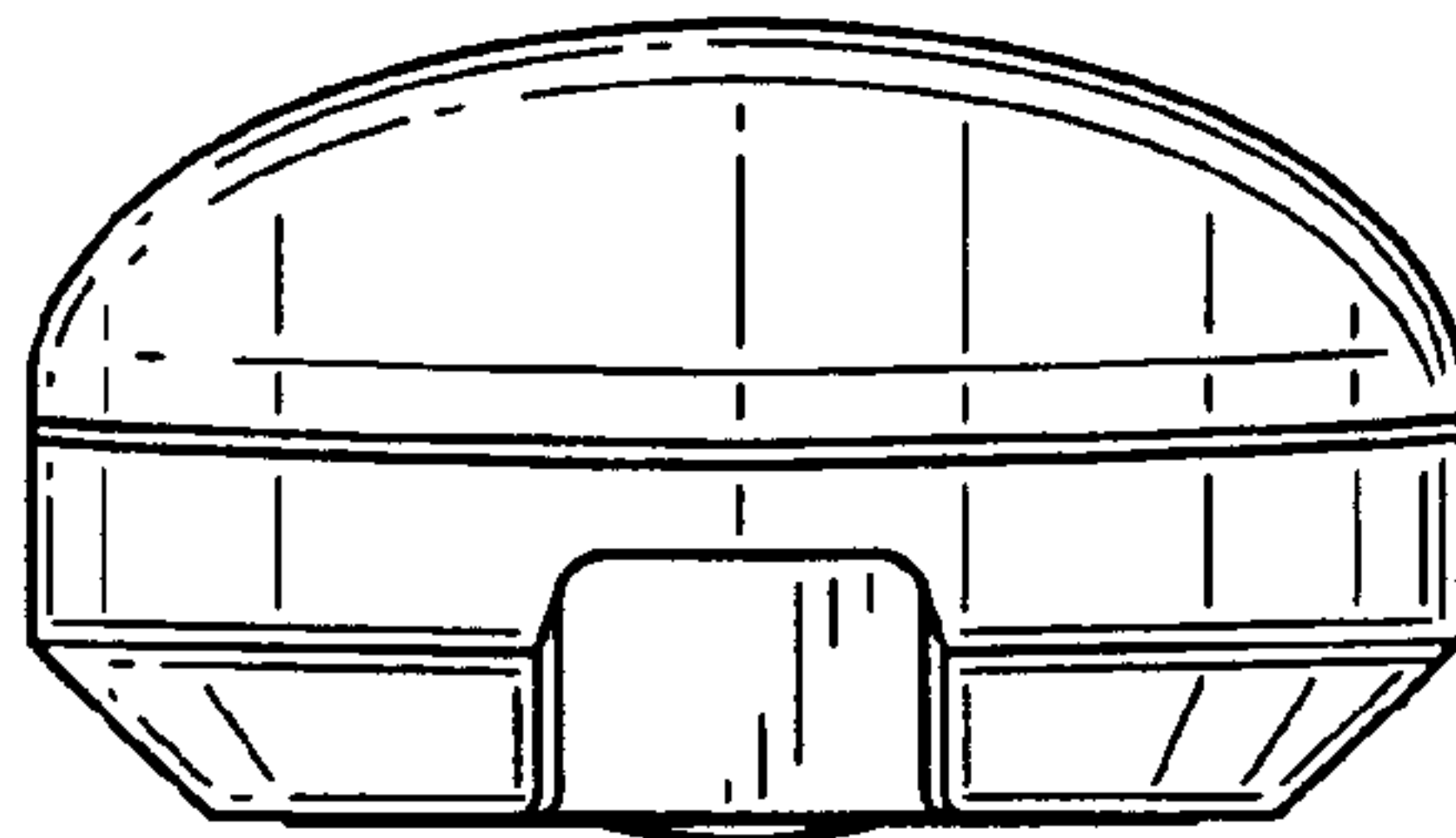

FIG. 14