



US00D434244S

# United States Patent [19]

[11] Patent Number: Des. 434,244

Natuzzi et al.

[45] Date of Patent: \*\* Nov. 28, 2000

[54] SEAT

[75] Inventors: Pasquale Natuzzi, Bari; Arcangelo Scarati, Taranto, both of Italy

[73] Assignee: Industrie Natuzzi, Spa, Italy

[\*\*] Term: 14 Years

[21] Appl. No.: 29/103,880

[22] Filed: Apr. 23, 1999

[51] LOC (7) Cl. .... 06-01

[52] U.S. Cl. .... D6/381; D6/334

[58] Field of Search ..... D6/334, 335, 336, D6/364, 371, 373, 381, 500, 501, 502; 5/12.1; 297/232, 445.1, 446.1

### [56] References Cited

#### U.S. PATENT DOCUMENTS

D. 168,498	12/1952	Cleese, Jr. ....	D6/381
D. 355,309	2/1995	Natuzzi et al. ....	D6/381
D. 368,598	4/1996	Natuzzi et al. ....	D6/381
D. 372,370	8/1996	Natuzzi et al. ....	D6/381
D. 381,219	7/1997	Schweiger ....	D6/381
D. 381,528	7/1997	Natuzzi et al. ....	D6/381
D. 382,723	8/1997	Natuzzi et al. ....	D6/381
D. 384,215	9/1997	Chandler ....	D6/381
D. 385,121	10/1997	Natuzzi et al. ....	D6/381
D. 393,759	4/1998	Natuzzi et al. ....	D6/381
D. 402,482	12/1998	Gibson ....	D6/381
D. 412,623	8/1999	Zaidman ....	D6/381
D. 414,954	10/1999	Christa et al. ....	D6/381
D. 415,628	10/1999	Lewis ....	D6/381
D. 415,904	11/1999	Zaidman ....	D6/381
1,273,968	7/1918	Whedon ....	5/12.1

#### OTHER PUBLICATIONS

R Jones, Sofa #6085 by Christiansen. Bloomingdale's, Sofa "B" at top right, p. 16.  
 Rowe 1995 2nd ed., p. 15, Sofa #16 H at bottom right.  
 Natuzzi Model 152, at least as early as 1987, at International Home Furnishings Market in High Point, North Carolina.  
 Natuzzi Model 499, Apr. 1989, at International Home Furnishings Market in High Point, North Carolina.

Natuzzi Model 616/617, Oct. 1988, at International Home Furnishings Market in High Point, North Carolina.  
 Natuzzi Model 622/623, Oct. 1988, at International Home Furnishings Market in High Point, North Carolina.  
 Natuzzi Model 647, Apr. 1989, at International Home Furnishings Market in High Point, North Carolina.  
 Natuzzi Model 664/665, Oct. 1991, at International Home Furnishings Market in High Point, North Carolina.  
 Natuzzi Model 768, Apr. 1990, at International Home Furnishings Market in High Point, North Carolina.  
 Natuzzi Model 782, Oct. 1990, at International Home Furnishings Market in High Point, North Carolina.  
 Natuzzi Model 841, Apr. 1991, at International Home Furnishings in High Point, North Carolina.

(List continued on next page.)

Primary Examiner—Gary D. Watson  
Attorney, Agent, or Firm—Alston & Bird LLP

### [57] CLAIM

The ornamental design for a seat, as shown and described.

#### DESCRIPTION

FIG. 1 is a front perspective view of a seat showing our new design in the form of a sofa;  
 FIG. 2 is a front elevational view thereof;  
 FIG. 3 is a top plan view thereof;  
 FIG. 4 is a right side elevational view, the left side being a mirror image thereof;  
 FIG. 5 is a rear perspective view thereof;  
 FIG. 6 is a front elevational view of a seat showing our new design in the form of a loveseat; and,  
 FIG. 7 is a front elevational view of a seat showing our new design in the form of a chair.  
 The broken lines shown herein are for illustrative purposes only and form no part of the claimed design.  
 The rear views of FIGS. 6 and 7 are like FIG. 5, the difference being a matter of length.  
 The end views of FIGS. 6 and 7 are like FIG. 4.  
 FIG. 1 has been shown on an enlarged scale with respect to the other views.

1 Claim, 3 Drawing Sheets

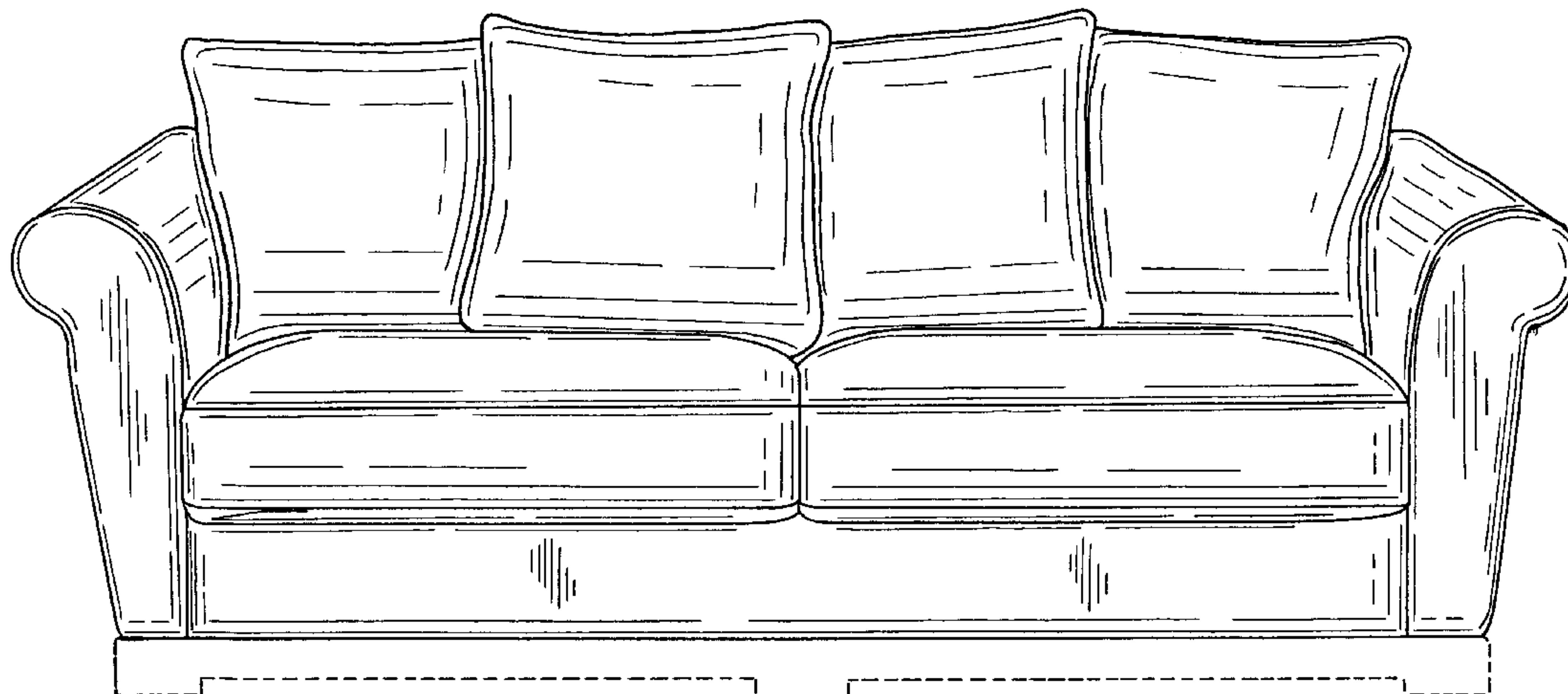

OTHER PUBLICATIONS

Natuzzi Model 847, Apr. 1991, at International Home Furnishings Market in High Point, North Carolina.

Natuzzi Model 1032, Apr. 1993, at International Home Furnishings Market in High Point, North Carolina.

Natuzzi Model 1081, Sep. 1993, at International Home Furnishings Market in High Point, North Carolina.

Natuzzi Model 1084, Sep. 1993, at International Home Furnishings Market in High Point, North Carolina.

Natuzzi Model 1165, Apr. 1994, at International Home Furnishings Market in High Point, North Carolina.

Natuzzi Model 1178, Apr. 1994, at International Home Furnishings Market in High Point, North Carolina.

Natuzzi Model 1180, Apr. 1994, at International Home Furnishings Market in High Point, North Carolina.

Natuzzi Model 1187, Apr. 1994, at International Home Furnishings Market in High Point, North Carolina.

Natuzzi Model 1217, Oct. 1994, at International Home Furnishings Market in High Point, North Carolina.

Natuzzi Model 1275, Mar. 1995, at International Home Furnishings Market in High Point, North Carolina.

Natuzzi Model 1306, Mar. 1995, at International Home Furnishings Market in High Point, North Carolina.

Natuzzi Model 1315, Apr. 1995, at International Home Furnishings Market in High Point, North Carolina.

Natuzzi Model 1338, Sep. 1995, at International Home Furnishings Market in High Point, North Carolina.

Natuzzi Model 1437, Mar. 1996, at International Home Furnishings Market in High Point, North Carolina.

Natuzzi Model 1636, Oct. 1997, at International Home Furnishings Market in High Point, North Carolina.

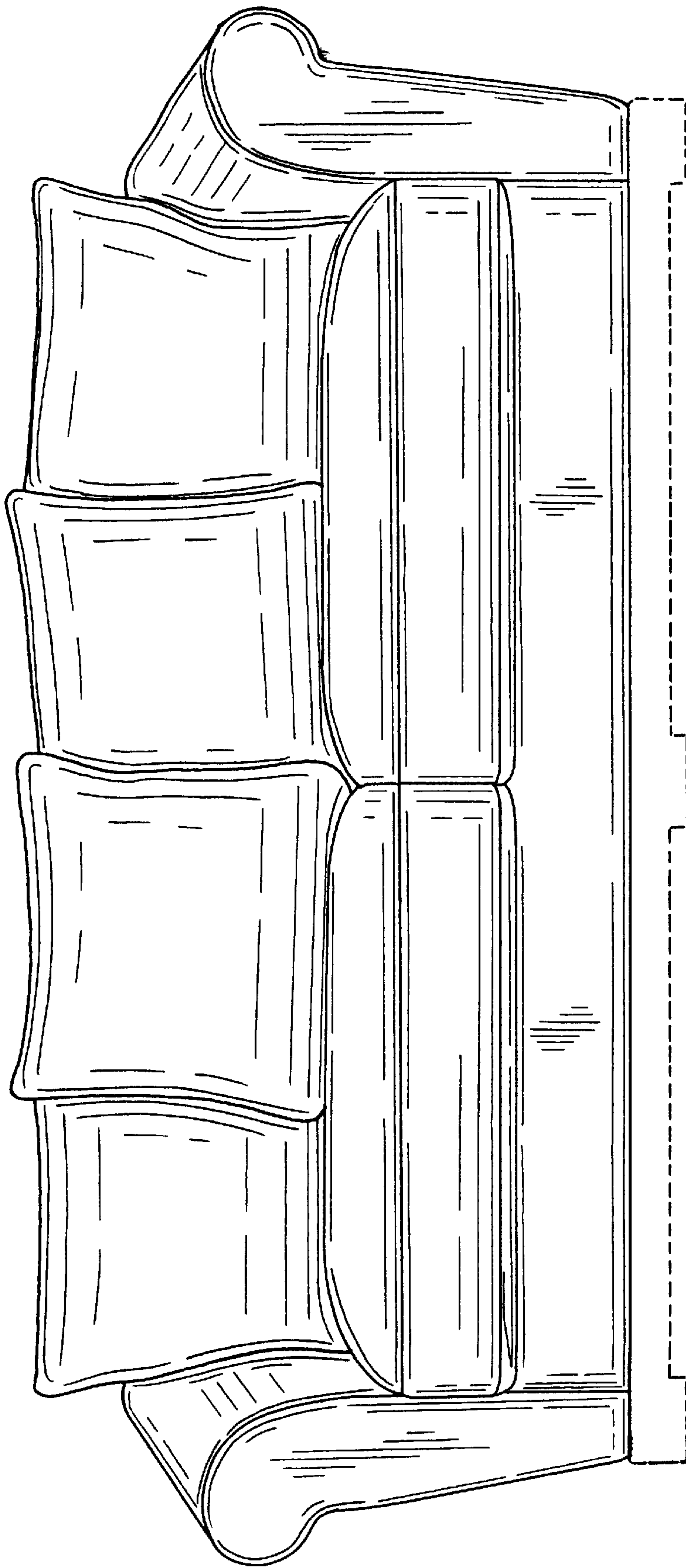

FIG. 1.



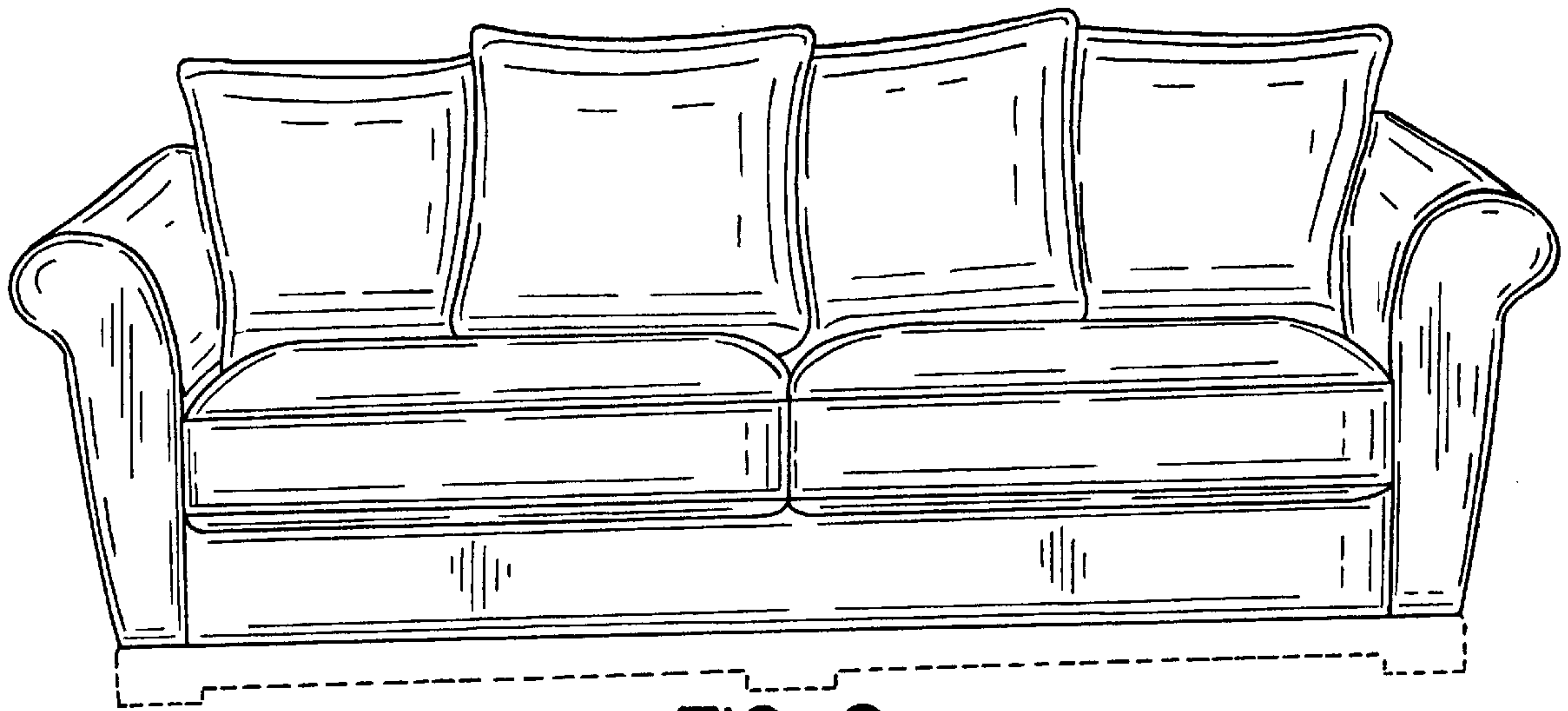

FIG. 2.

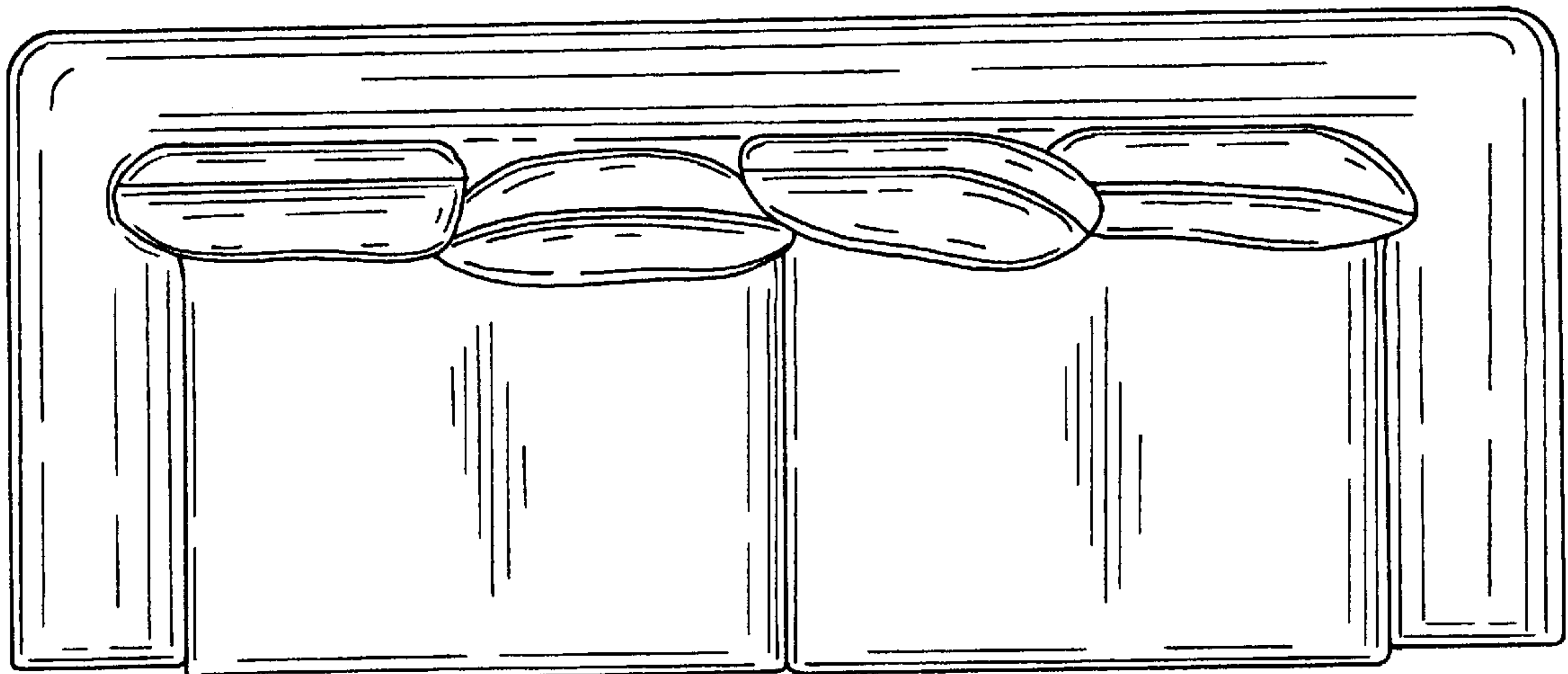

FIG. 3.

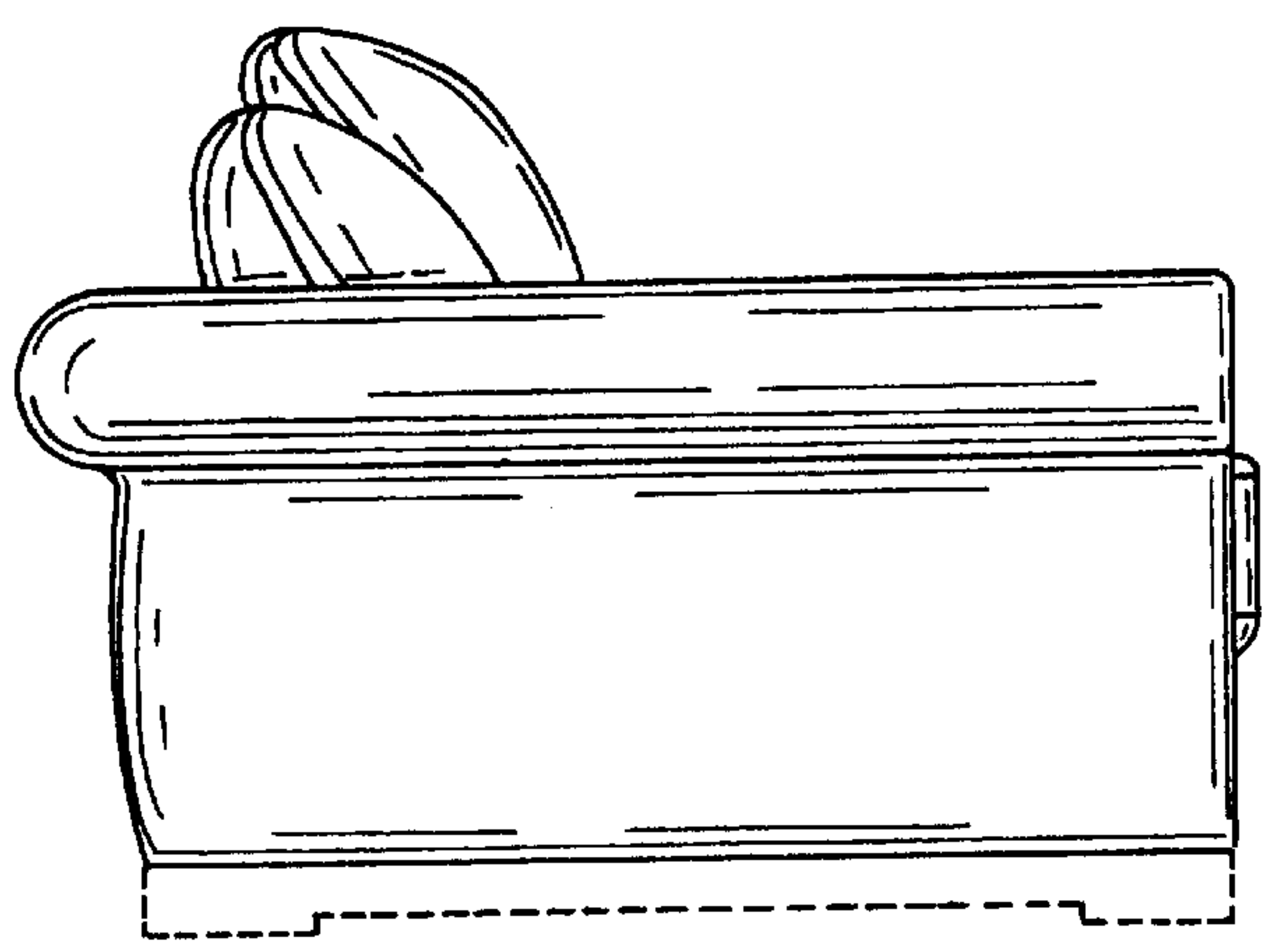

FIG. 4.

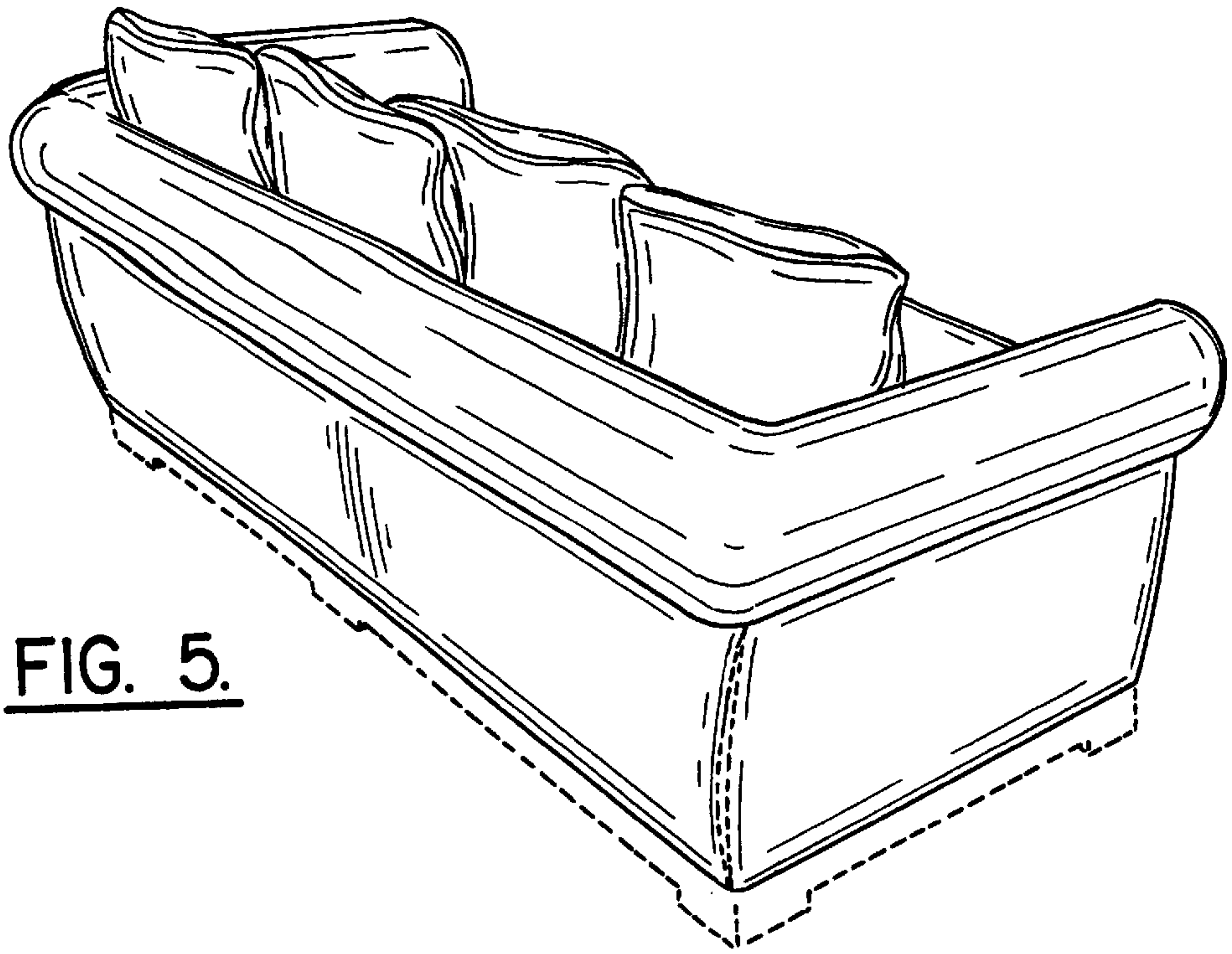

FIG. 5.

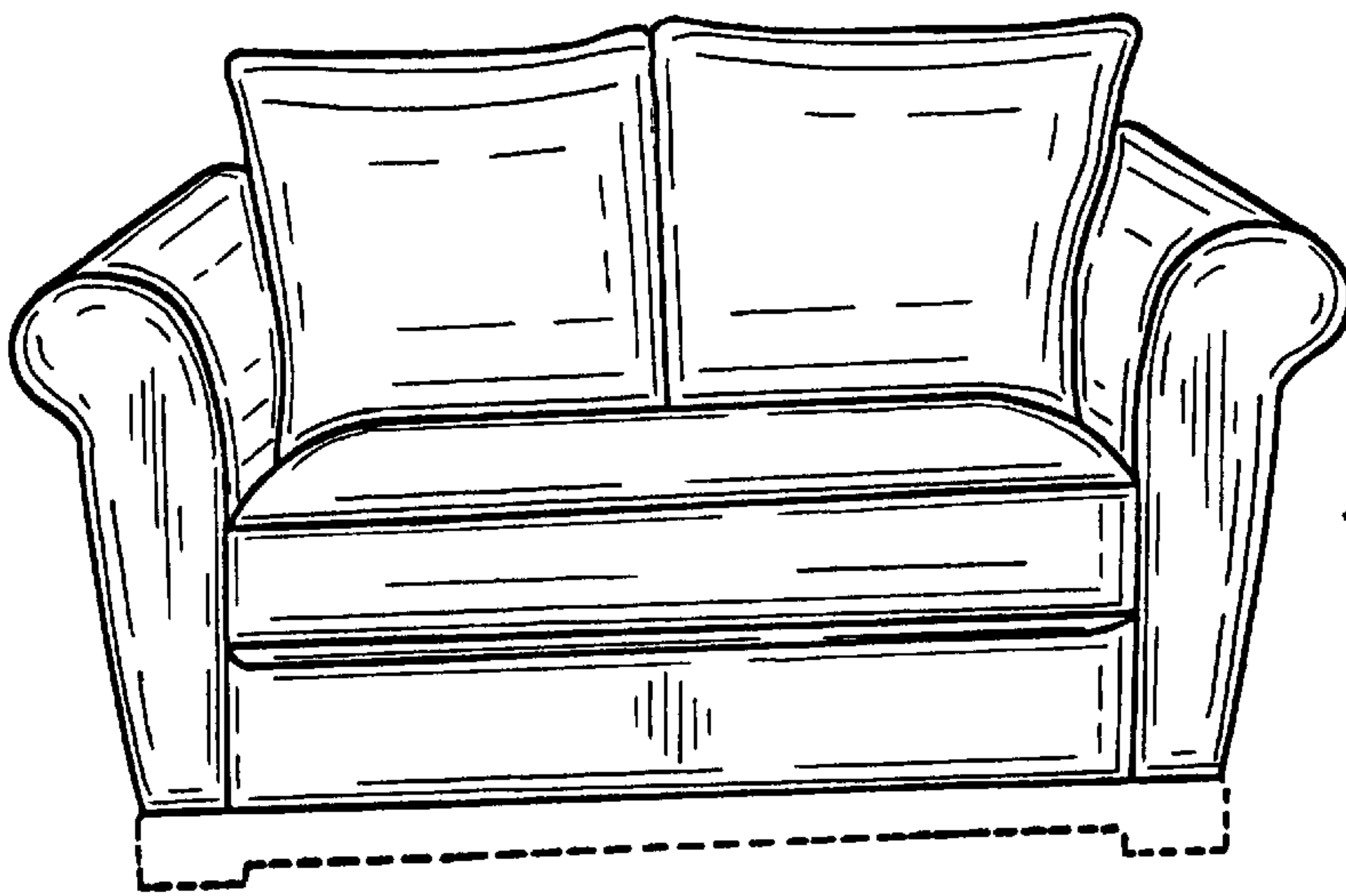

FIG. 6.

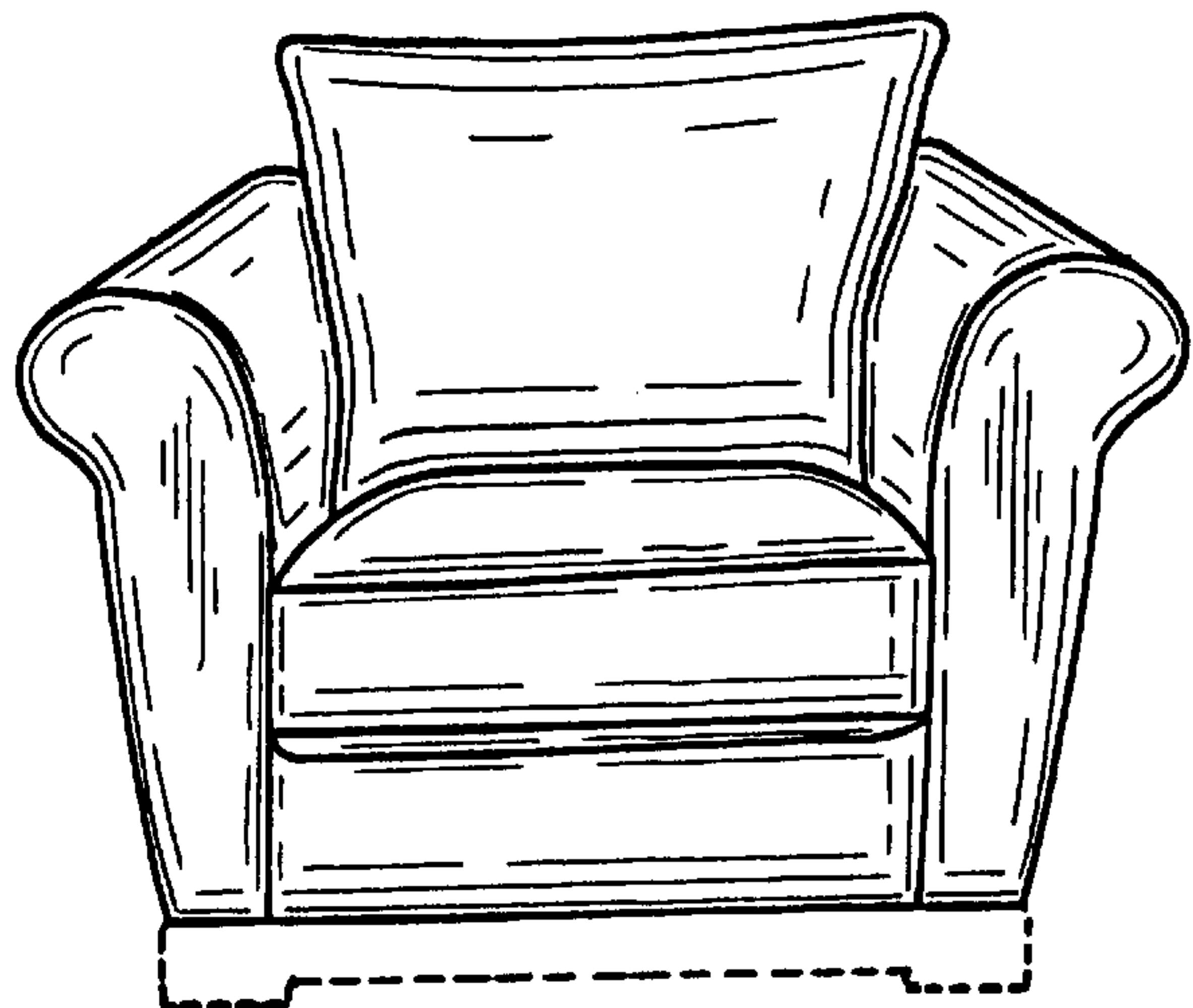

FIG. 7.