



US00D434070S

United States Patent [19]

[11] Patent Number: **Des. 434,070**

Lin et al.

[45] Date of Patent: **** Nov. 21, 2000**

[54] **CALCULATOR WITH PERPETUAL CALENDAR**

D. 427,630 7/2000 Chu et al. D19/21
3,827,168 8/1974 Mori 40/110
5,480,118 1/1996 Cross 40/120 X

[75] Inventors: **Min-Hua Lin; William H. K. Chu,**
both of Taipei, Taiwan

Primary Examiner—Martie K. Holtje
Attorney, Agent, or Firm—Bacon & Thomas, PLLC

[73] Assignee: **Limax Electronics Co., Ltd.,** Taipei,
Taiwan

[57] CLAIM

[**] Term: **14 Years**

The ornamental design for a calculator with perpetual calendar, as shown and described.

[21] Appl. No.: **29/123,482**

DESCRIPTION

[22] Filed: **May 19, 2000**

[51] **LOC (7) Cl.** **19-03**

[52] **U.S. Cl.** **D19/21; D18/2; D19/25;**
D10/2; D10/3; D10/15; D10/18

[58] **Field of Search** D18/2, 6, 7; D19/20,
D19/21, 25; D10/2, 3, 15, 18; D14/100–113;
434/304; 283/2; 368/10, 11, 12, 21, 28–30,
46, 276–285, 82–84, 239–242; 40/107–122;
235/61 R

FIG. 1 is a perspective view of the calculator with perpetual calendar in a closed state showing the new design; FIG. 2 is a front view of the new design in a closed state; FIG. 3 is a rear view of the new design in a closed state; FIG. 4 is a left side view of the new design in a closed state; FIG. 5 is a right view of the new design in a closed state; FIG. 6 is a top view of the new design in a closed state; FIG. 7 is a bottom view of the new design in a closed state; FIG. 8 is a perspective view of the new design in an opened state; FIG. 9 is a front view of the new design in an opened state; FIG. 10 is a rear view of the new design in an opened state; FIG. 11 is a left side view of the new design in an opened state; FIG. 12 is a right view of the new design in an opened state; FIG. 13 is a top view of the new design in an opened state; and, FIG. 14 is a bottom view of the new design in an opened state.

[56] References Cited

U.S. PATENT DOCUMENTS

- D. 147,742 10/1947 Bowers D10/3
- D. 163,586 6/1951 Dingeldein D19/21
- D. 274,798 7/1984 O'Hara et al. D14/106
- D. 292,710 11/1987 Woods D14/100
- D. 352,664 11/1994 Peersmann D10/2
- D. 363,881 11/1995 Yung D10/18
- D. 366,621 1/1996 George et al. D10/15
- D. 427,629 7/2000 Chu et al. D19/21

1 Claim, 8 Drawing Sheets

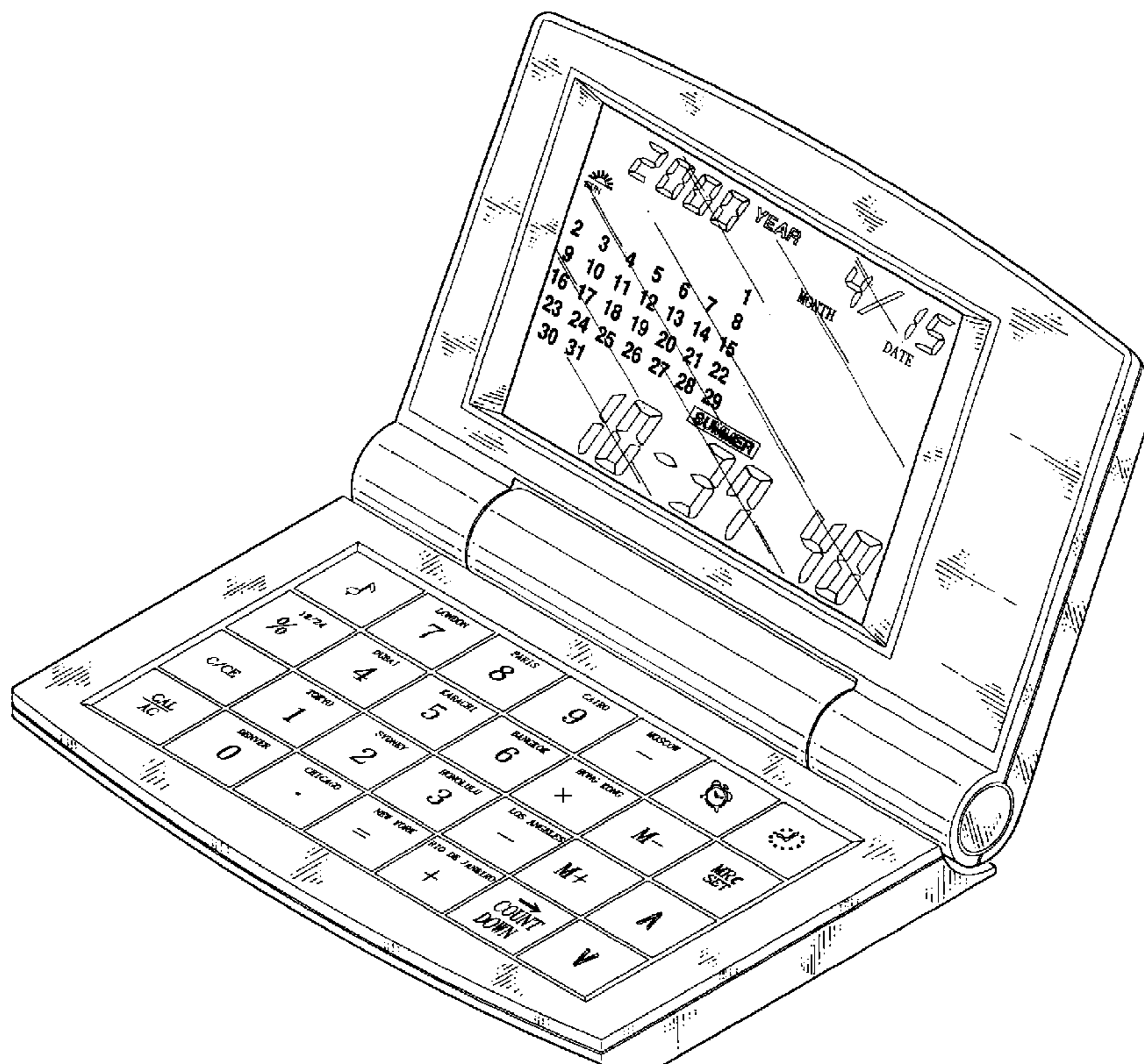

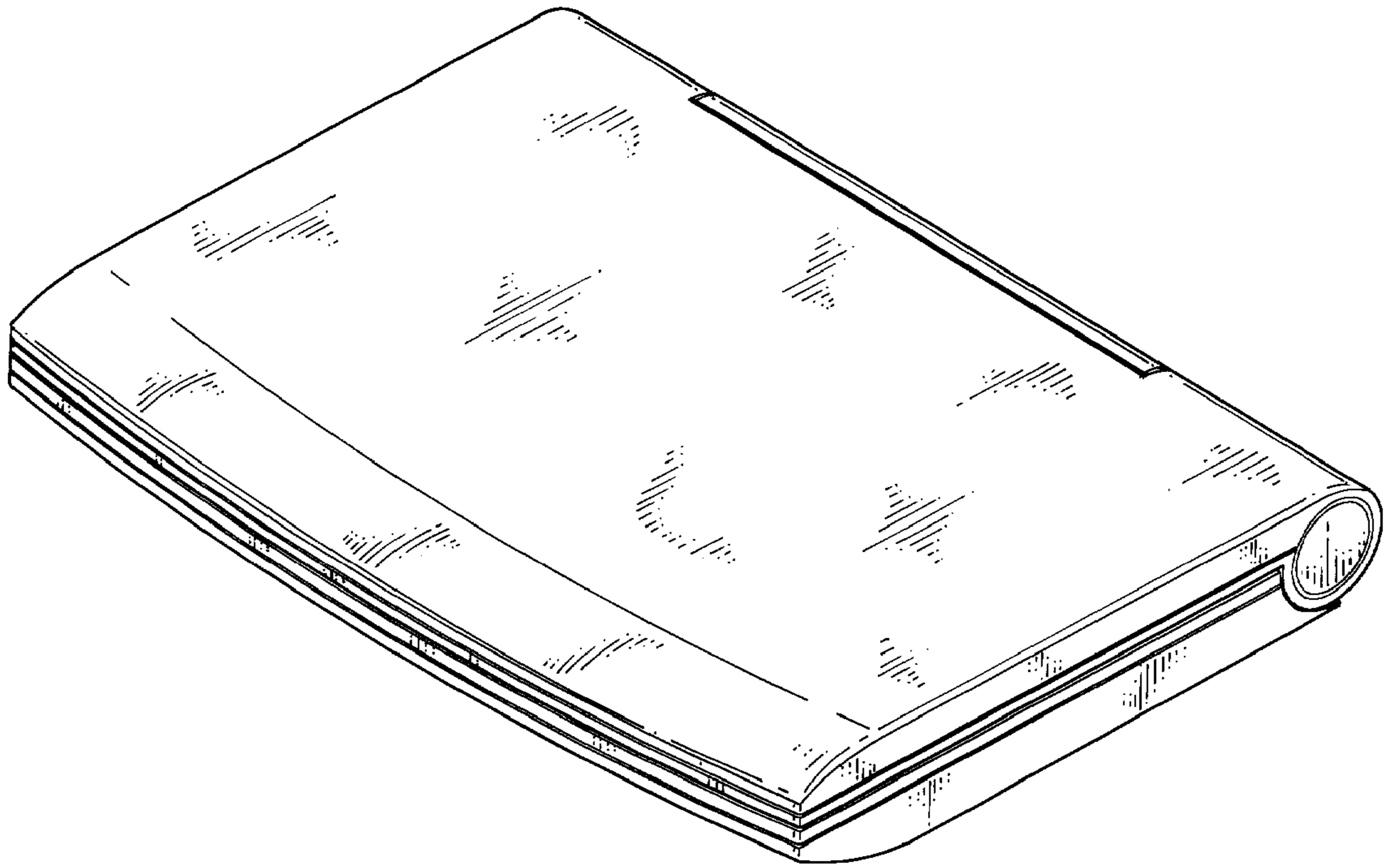

Fig. 1

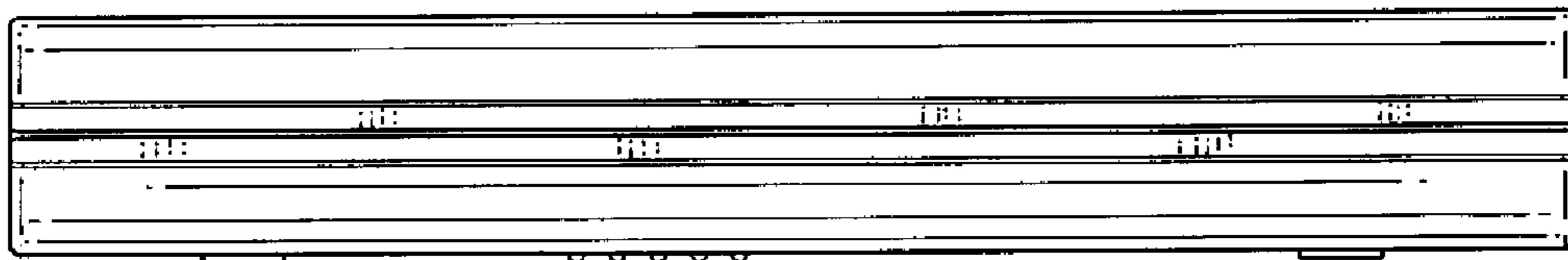

Fig. 2

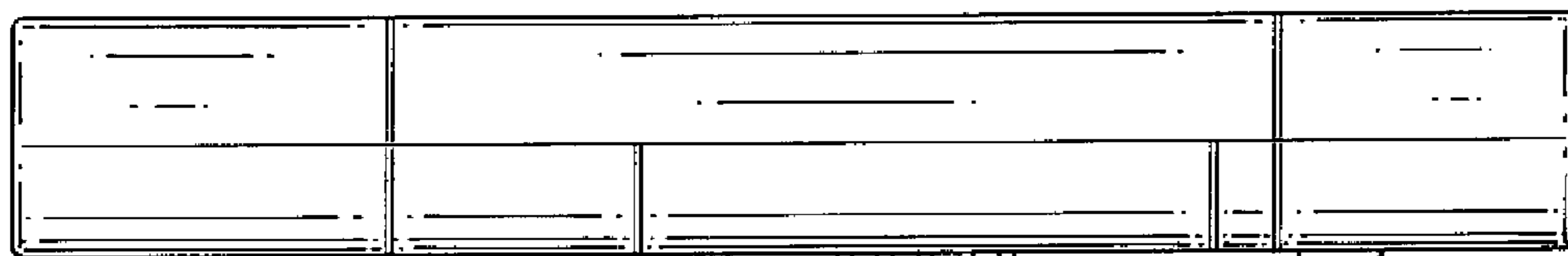

Fig. 3

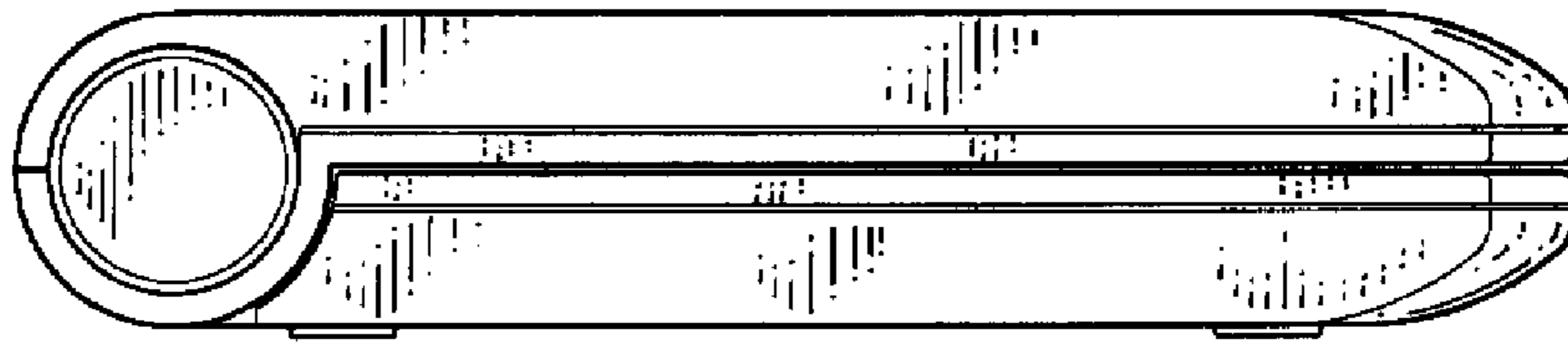

Fig. 4

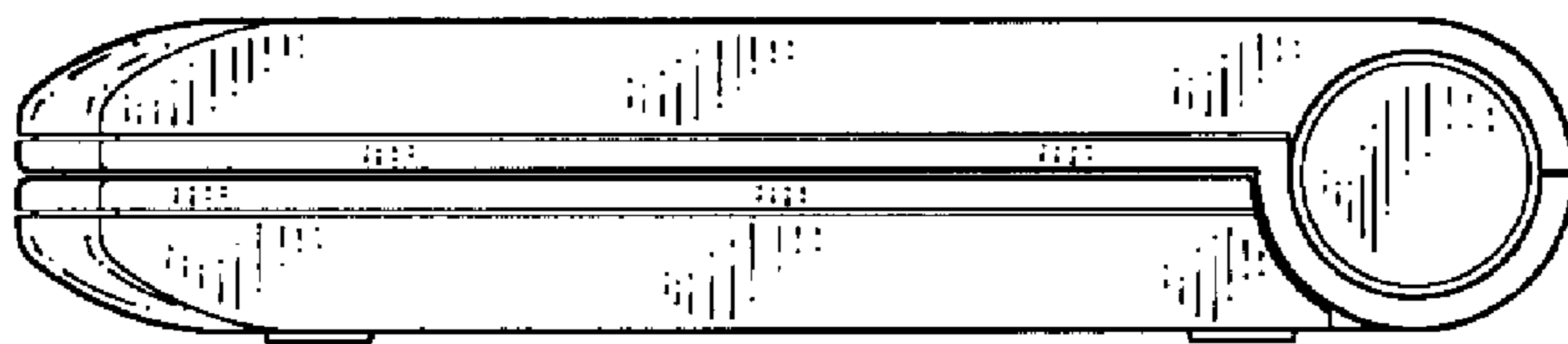

Fig. 5

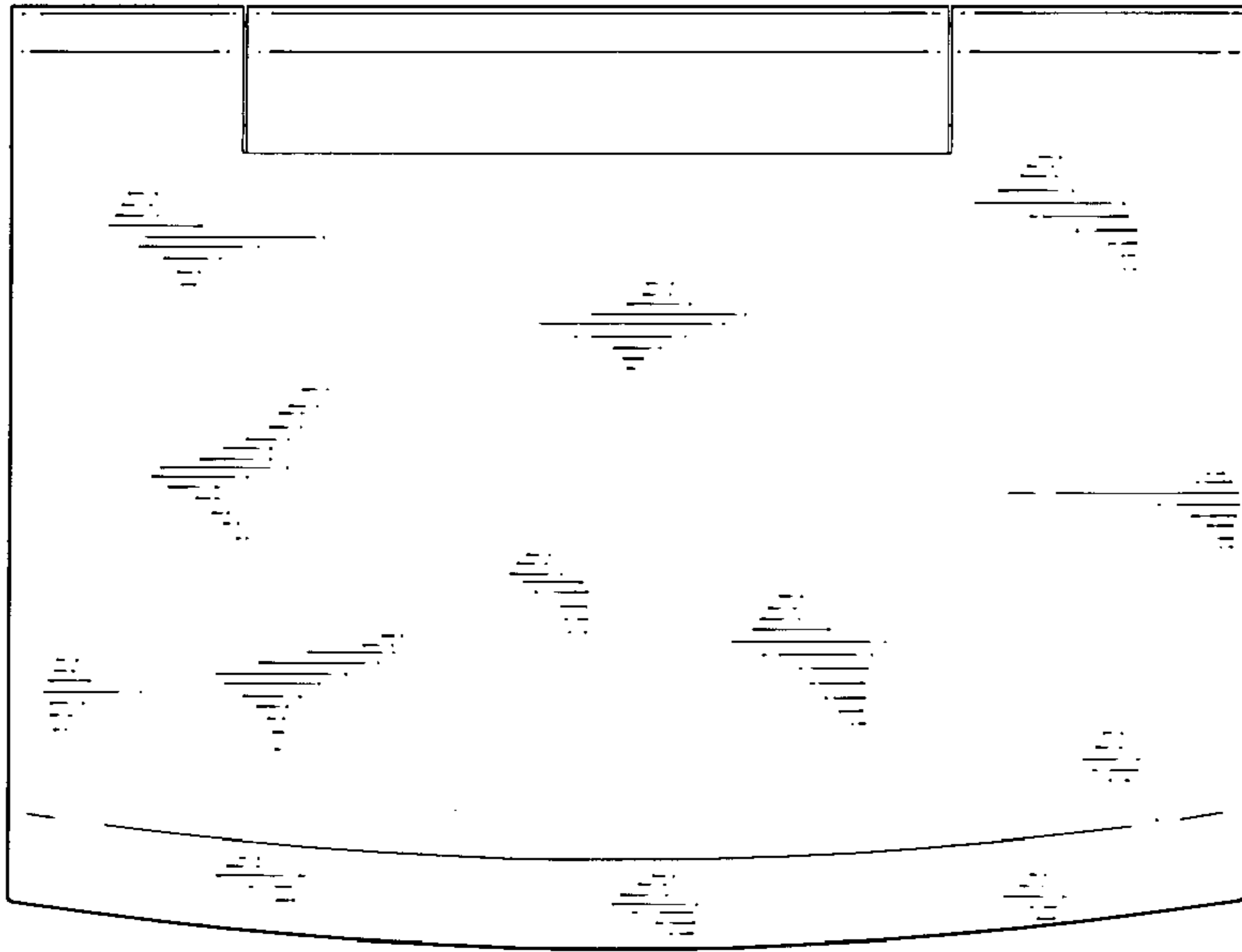

Fig. 6

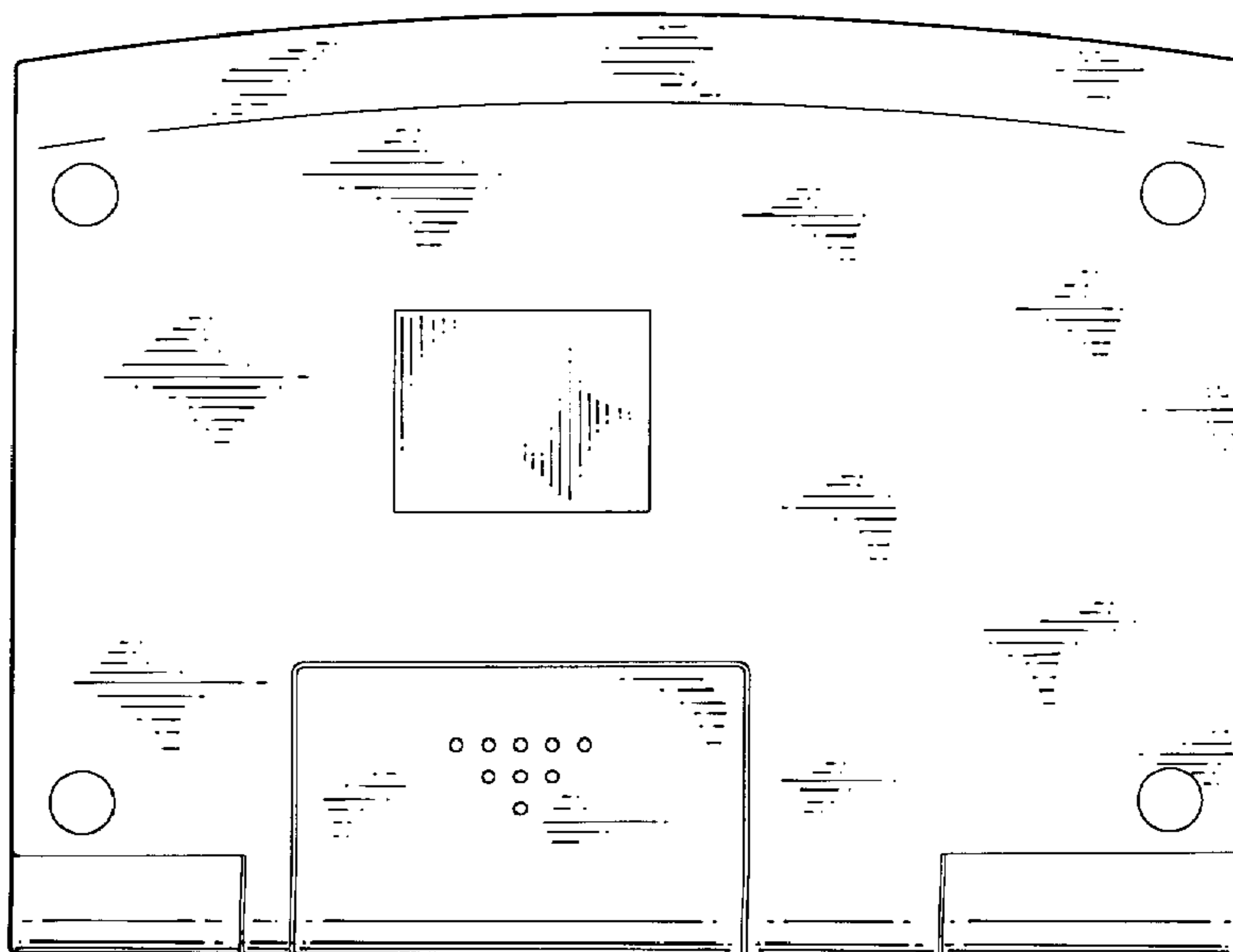

Fig. 7

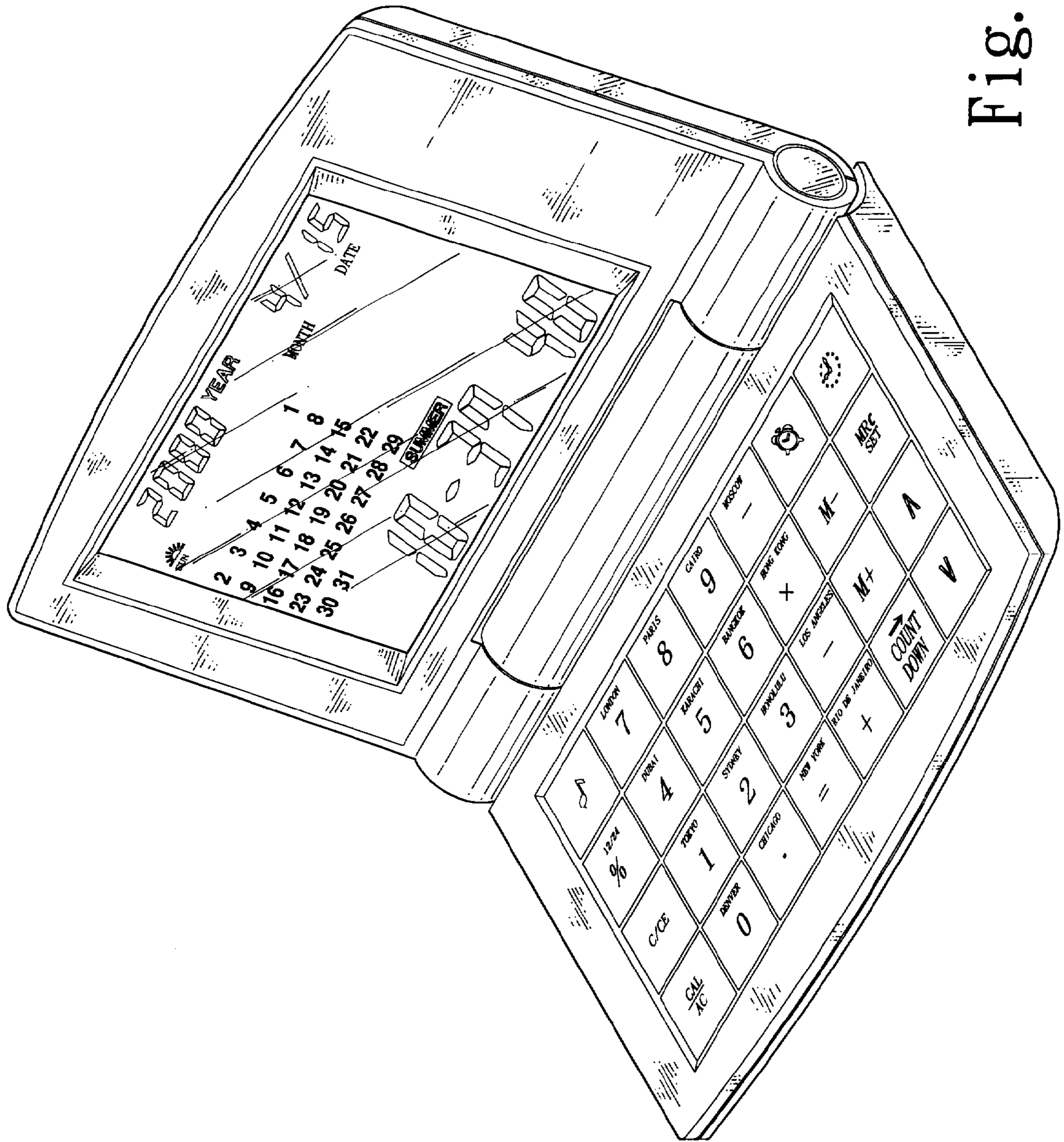

Fig. 8

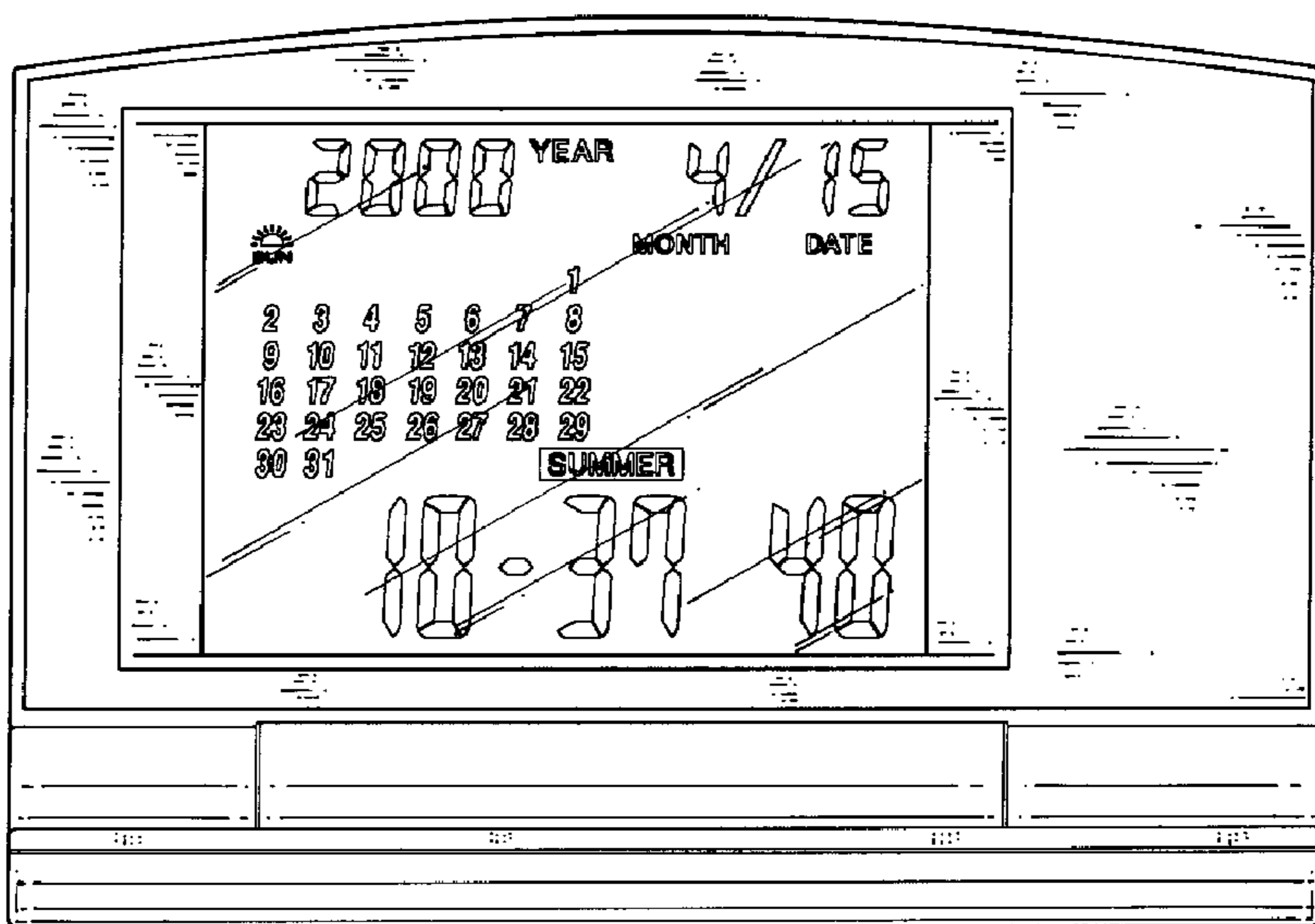

Fig. 9

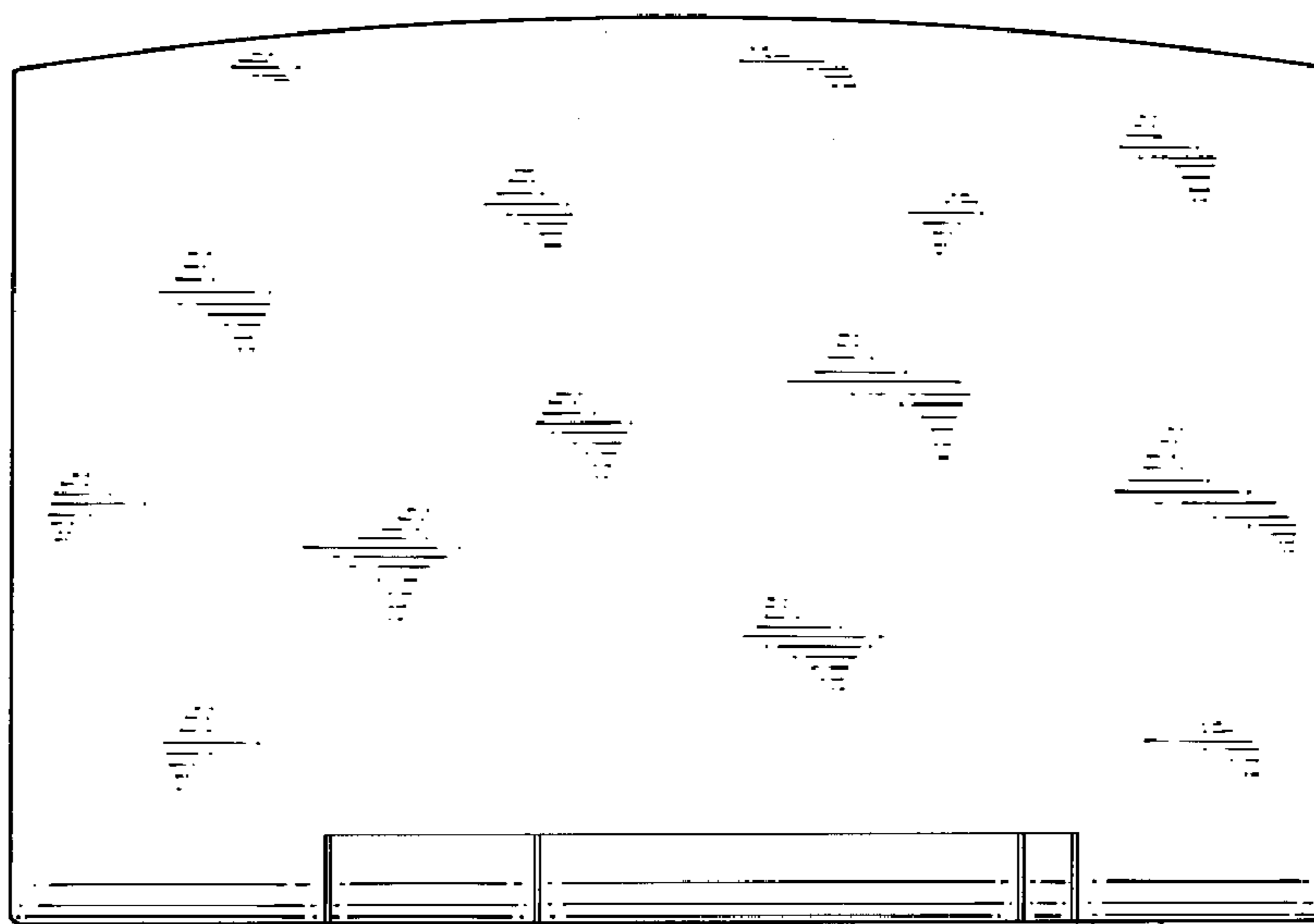

Fig. 10

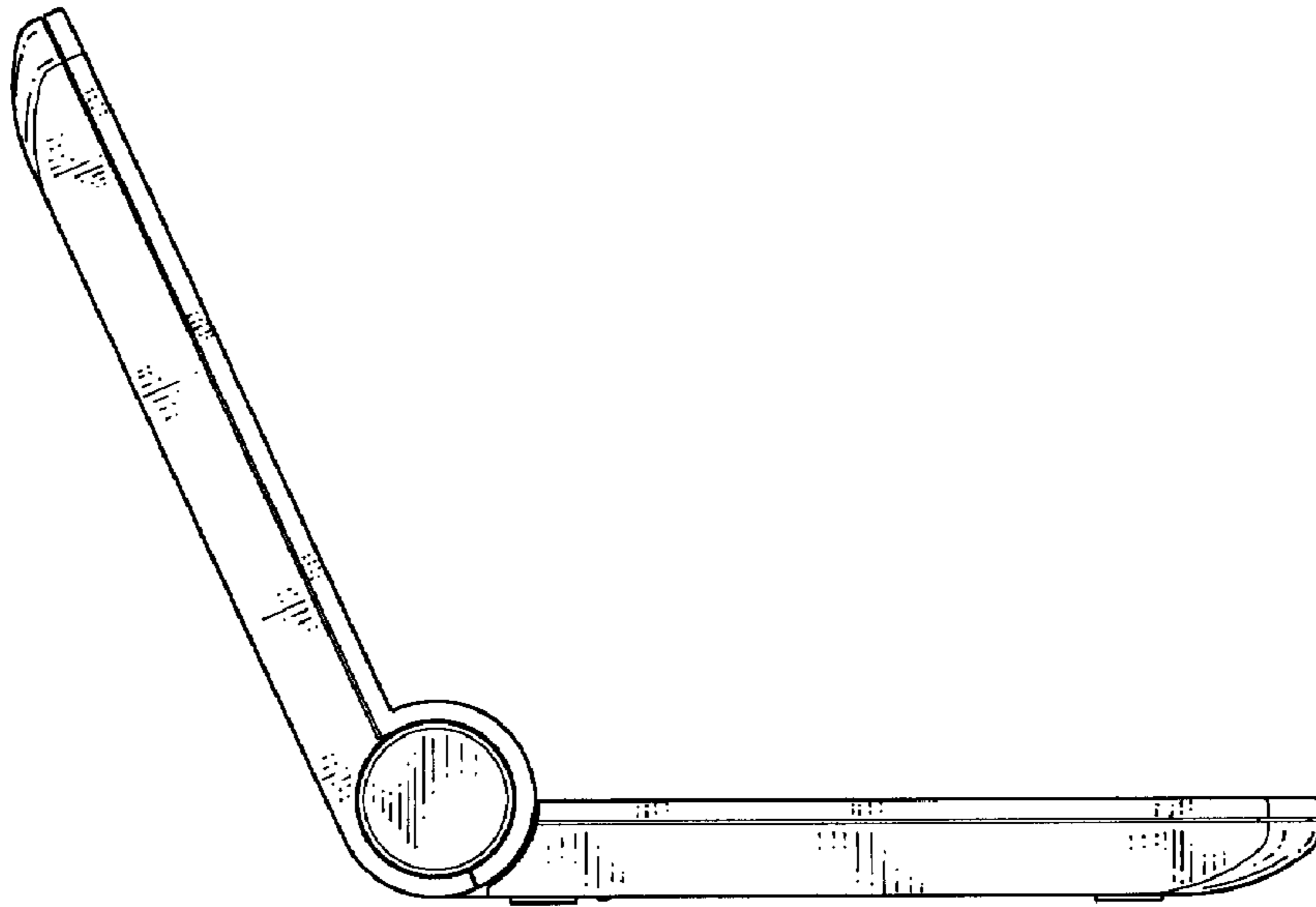

Fig. 11

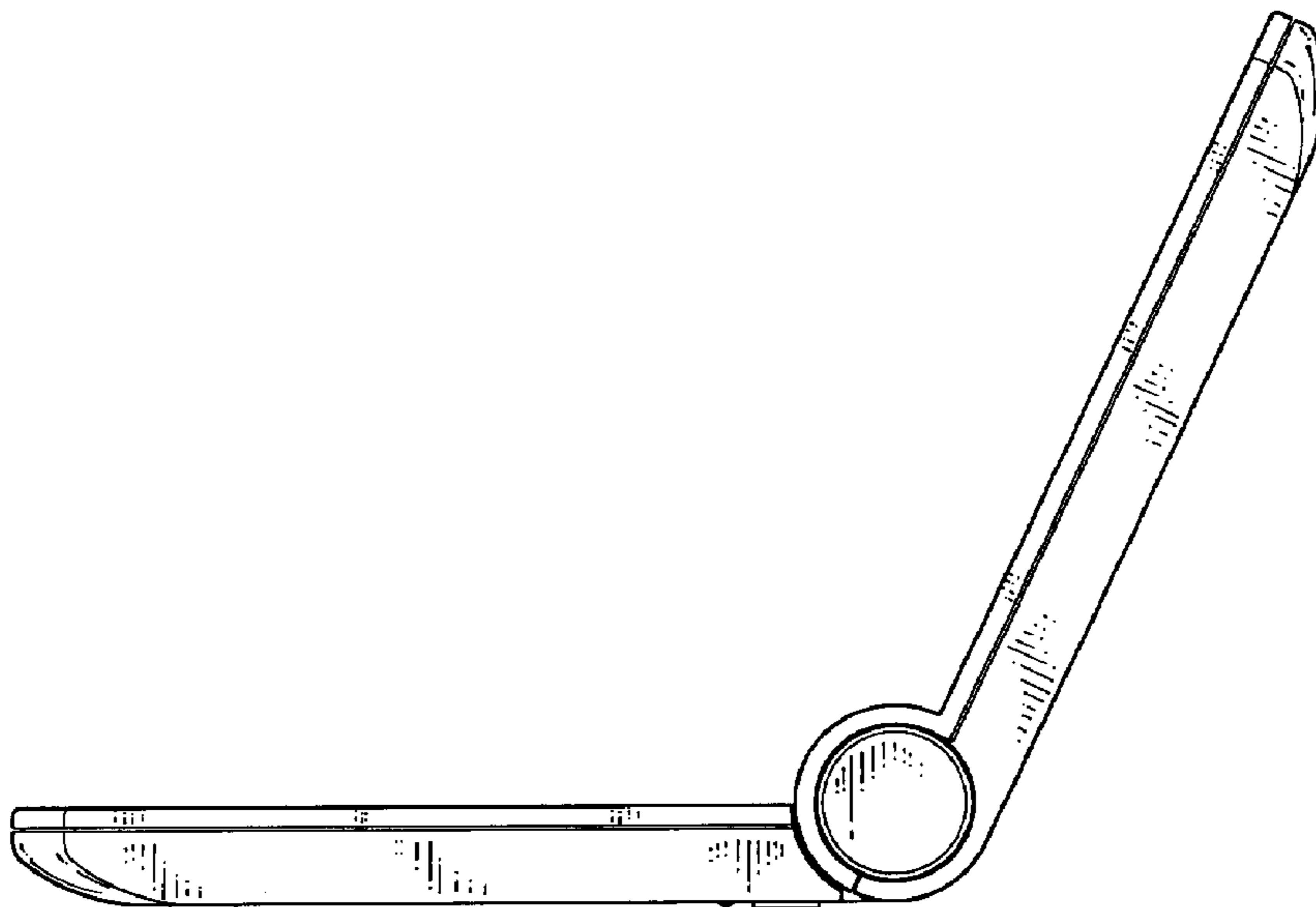

Fig. 12

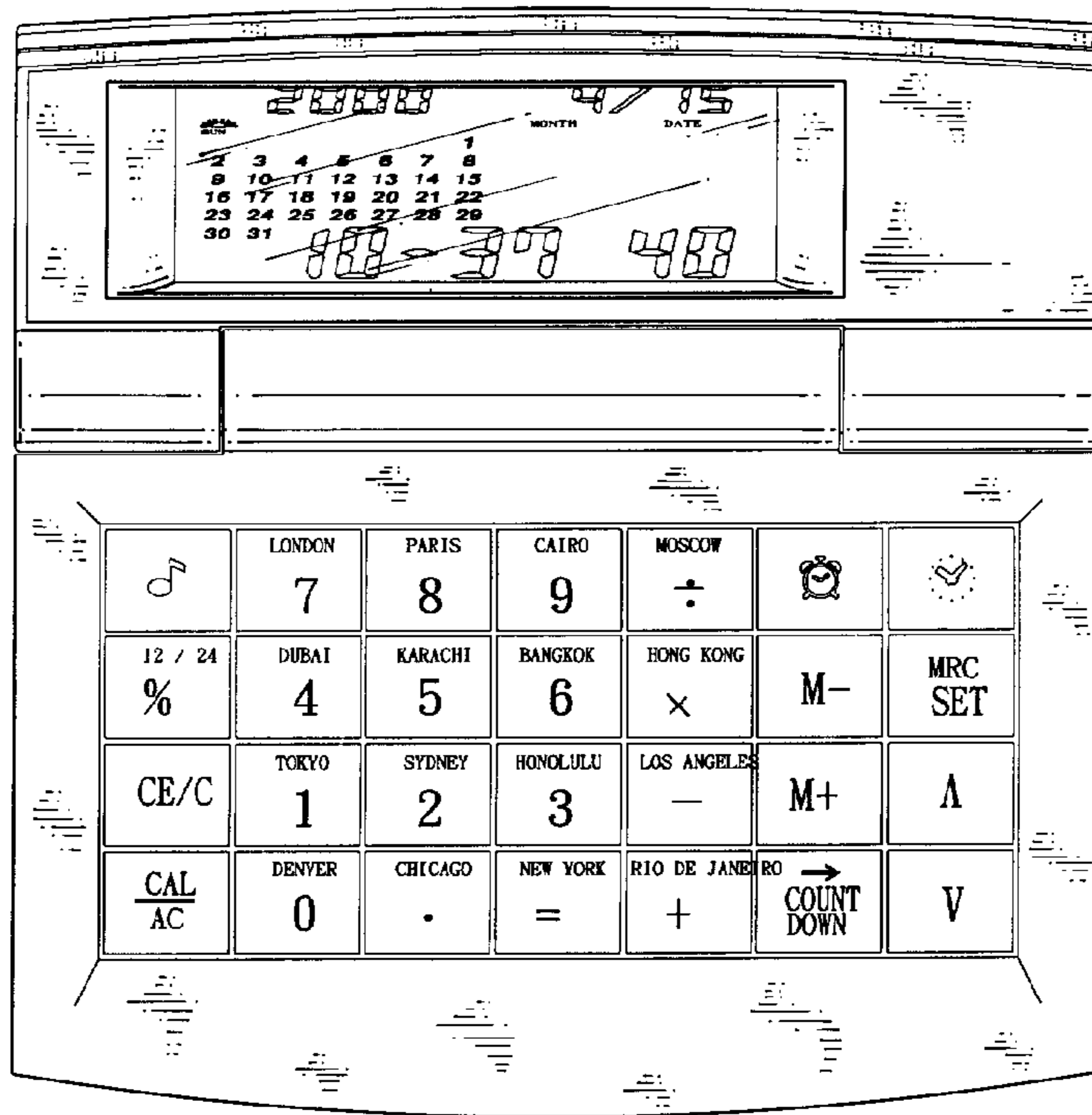

Fig. 13

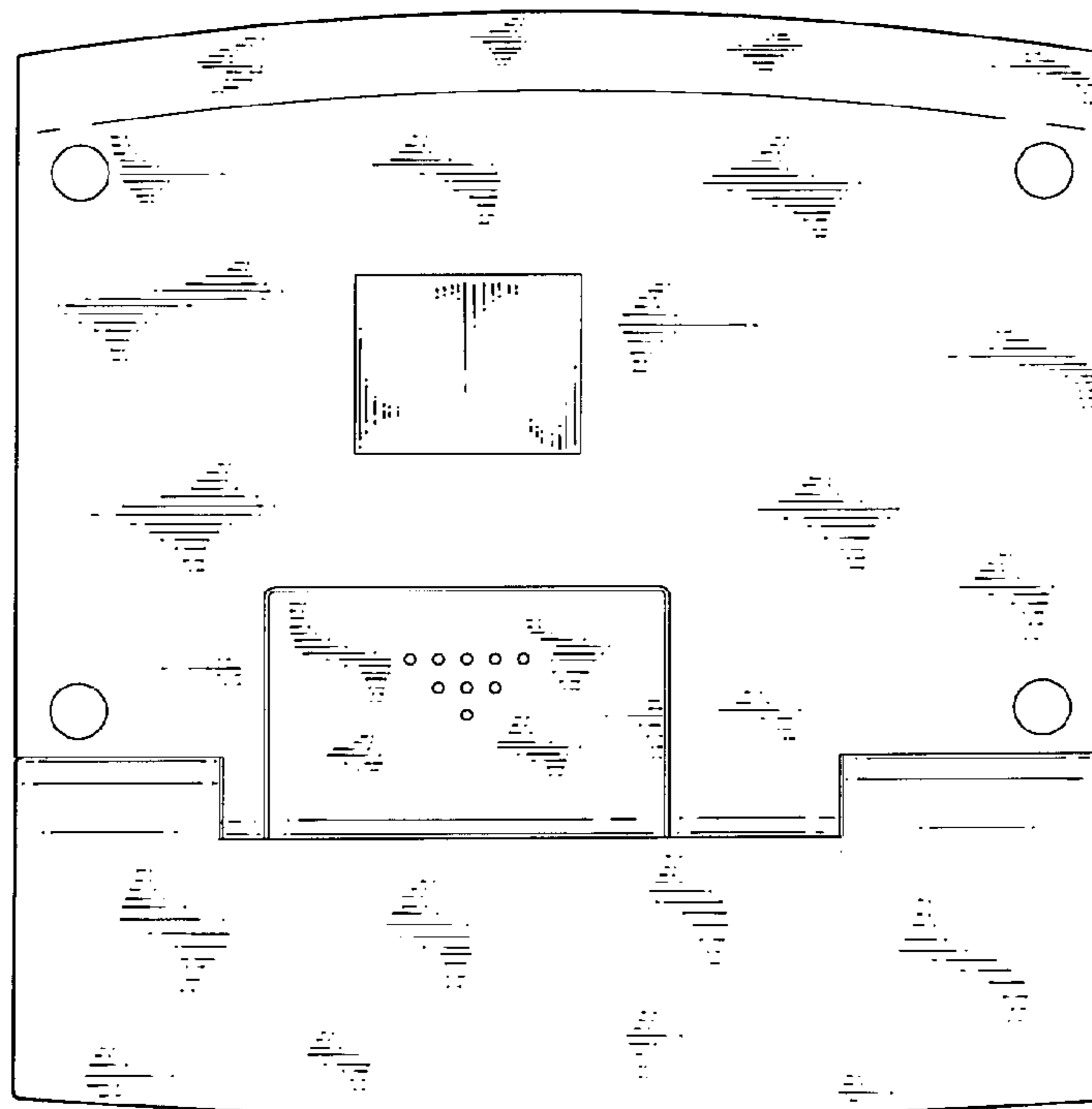

Fig. 14