



US00D434015S

# United States Patent [19]

[11] **Patent Number: Des. 434,015**

**Oe et al.**

[45] **Date of Patent: \*\* Nov. 21, 2000**

[54] **REAR PROJECTION TELEVISION**

[75] Inventors: **Shinji Oe**, La Jolla; **John F. Novak**, Lafayette, both of Calif.

[73] Assignee: **Hitachi Home Electronics (America), Inc.**, San Diego, Calif.

[\*\*] Term: **14 Years**

[21] Appl. No.: **29/110,225**

[22] Filed: **Sep. 1, 1999**

[51] **LOC (7) Cl.** ..... **14-03**

[52] **U.S. Cl.** ..... **D14/128; D14/133**

[58] **Field of Search** ..... D14/126-134; 312/7.2; 348/787, 789, 836; 353/47, 74

[56] **References Cited**

**U.S. PATENT DOCUMENTS**

D. 354,486	1/1995	Morita et al.	.....	D14/133
D. 360,203	7/1995	Bourgerie	.....	D14/128
D. 368,087	3/1996	Gioscia	.....	D14/128
D. 384,659	10/1997	Suzuki	.....	D14/126
D. 410,917	6/1999	Novak et al.	.....	D14/128
D. 418,129	12/1999	Takizawa et al.	.....	D14/128
4,941,036	7/1990	Itoh	.....	358/60
5,742,358	4/1998	Iijima et al.	.....	348/789
5,808,704	9/1998	Yoshikawa et al.	.....	348/748

**OTHER PUBLICATIONS**

1999 Big Screen Televisions and Home Theater Systems—Mitsubishi—Believed to be known by others prior to Sep. 1, 1999.

Year 2000—Product Catalog with Diamond Series—Believed to be known by others prior to Sep. 1, 1999.

Digital Television—Panasonic—1998/1999—Believed to be known by others prior to Sep. 1, 1999.

A World of Features You Never Imagined Possible!—Hitachi—1996-1997.

Pioneer—At Home With Pioneer—1999 Audio/Video Product catalog—Believed to be known by others prior to Sep. 1, 1999.

Proscan—So Advanced Yet So Simple—1998 Catalog—Believed to be known by others prior to Sep. 1, 1999.

RCA Introducing RCA HDTV—Changing entertainment Again—Believed to be known by others prior to Sep. 1, 1999.

New Technology. New Questions.—RCA—1999/2000 Home Entertainment catalog—Believed to be known by others prior to Sep. 1, 1999.

RCA Products—P61930BL—1999—Believed to be known by others prior to Sep. 1, 1999.

55" High Definition Television—Samsung—Believed to be known by others prior to Sep. 1, 1999.

Sony—Television—1999 Training Guide—Believed to be known by others prior to Sep.1, 1999.

SBX—Ultravision—Hitachi—A Totally New Vision—1998-1999 Projection TV's—Believed to be known by others prior to Sep. 1, 1999.

Ultravision—Hitachi—Enter the age of digital entertainment—Believed to be known by others prior to Sep. 1, 1999.

Hitachi 1998-1999 Product Guide—Believed to be known by others prior to Sep. 1, 1999.

People who can watch any TV want to watch Hitachi Ultra Vision. Hitachi Ultravision—1998 (Football)—Believed to be known by others prior to Sep. 1, 1999.

(List continued on next page.)

*Primary Examiner*—Richelle Shelton  
*Attorney, Agent, or Firm*—Womble Carlyle Sandridge & Rice

[57] **CLAIM**

The ornamental design for a rear projection television, as shown and described.

**DESCRIPTION**

FIG. 1 is a perspective view of a rear projection television in accordance with our new design;

FIG. 2 is an enlarged front view of the rear projection television;

FIG. 3 is a side elevation view thereof;

FIG. 4 is a top view thereof;

FIG. 5 is a bottom view thereof; and,

FIG. 6 is a rear view thereof.

**1 Claim, 6 Drawing Sheets**

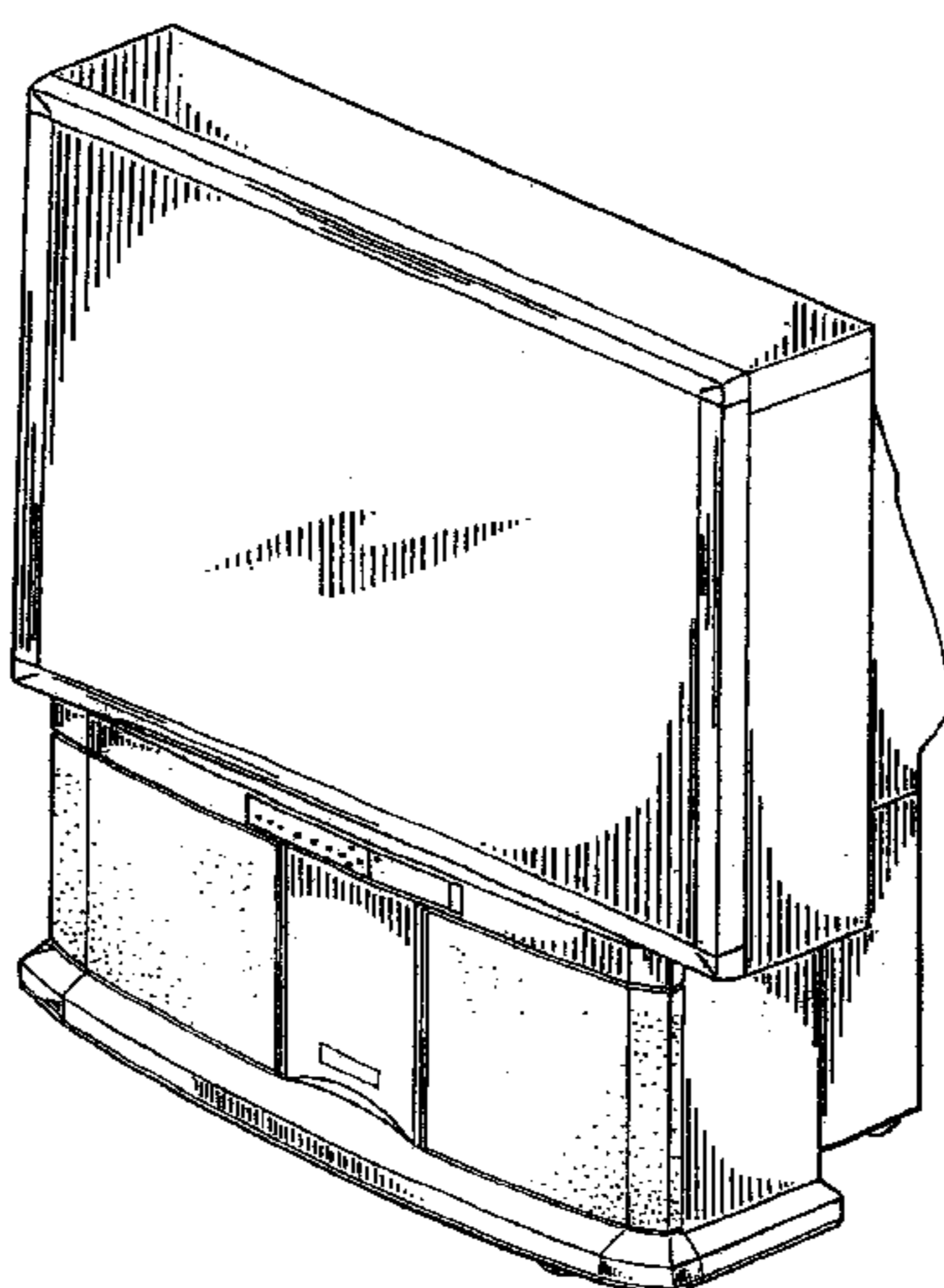

**OTHER PUBLICATIONS**

People who can watch and TV want to watch Hitachi UltraVision. Hitachi Ultravision—1998 (Fire)—Believed to be known by others prior to Sep. 1, 1999.

Ultravision—Hitachi (Specifications for several models)—Believed to be known by others prior to Sep. 1, 1999.

This is the Human Eye—An incredibly advanced imaging device that transmits sight impulses to the brain.—Hitachi—Believed to be known by others prior to Sep. 1, 1999.

A Totally New Vision—Television Camcorders VCR's Accessories—Hitachi—1997–1998—Believed to be known by others prior to Sep. 1, 1999.

Hitachi Home Electronics—1995–1996—Projection TV's, Big Screen Televisions, Camcorders, Audio Systems, Video Cassette Recorders, Accessories—Believed to be known by others prior to Sep. 1, 1999.

Hitachi Home Electronics—1994–1995 Product Guide—Believed to be known by others prior to Sep. 1, 1999.

Hitachi Home Electronics—1993–1994 Product Guide—Believed to be known by others prior to Sep. 1, 1999.

Hitachi 1993 Product Guide—Believed to be known by others prior to Sep. 1, 1999.

Hitachi Home Entertainment Products—1991–1992—Believed to be known by others prior to Sep. 1, 1999.

Hitachi Product Guide—Believed to be known by others prior to Sep. 1, 1999.

Hitachi—1989–1990 Product Guide—Believed to be known by others prior to Sep. 1, 1999.

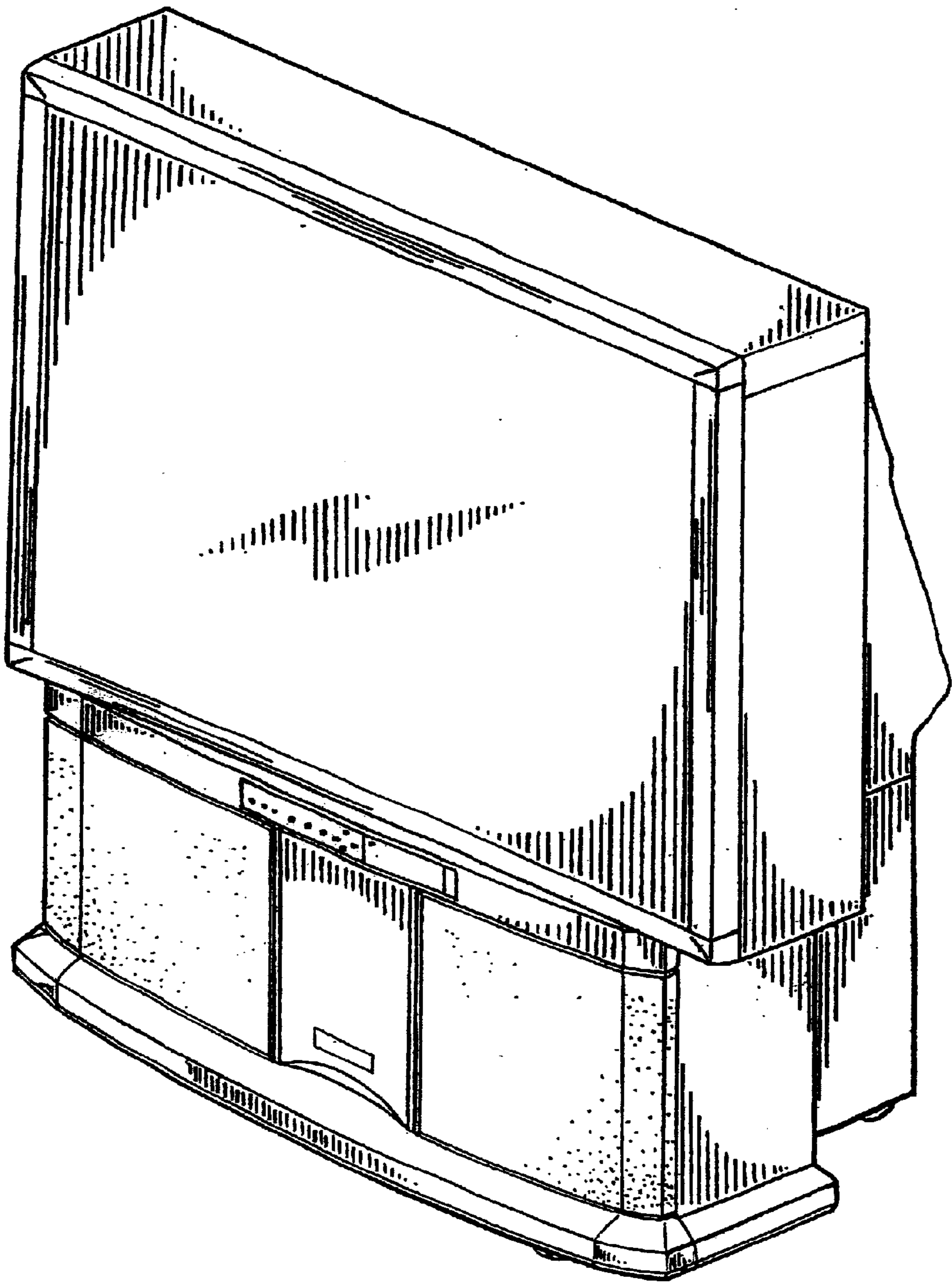

Fig. 1

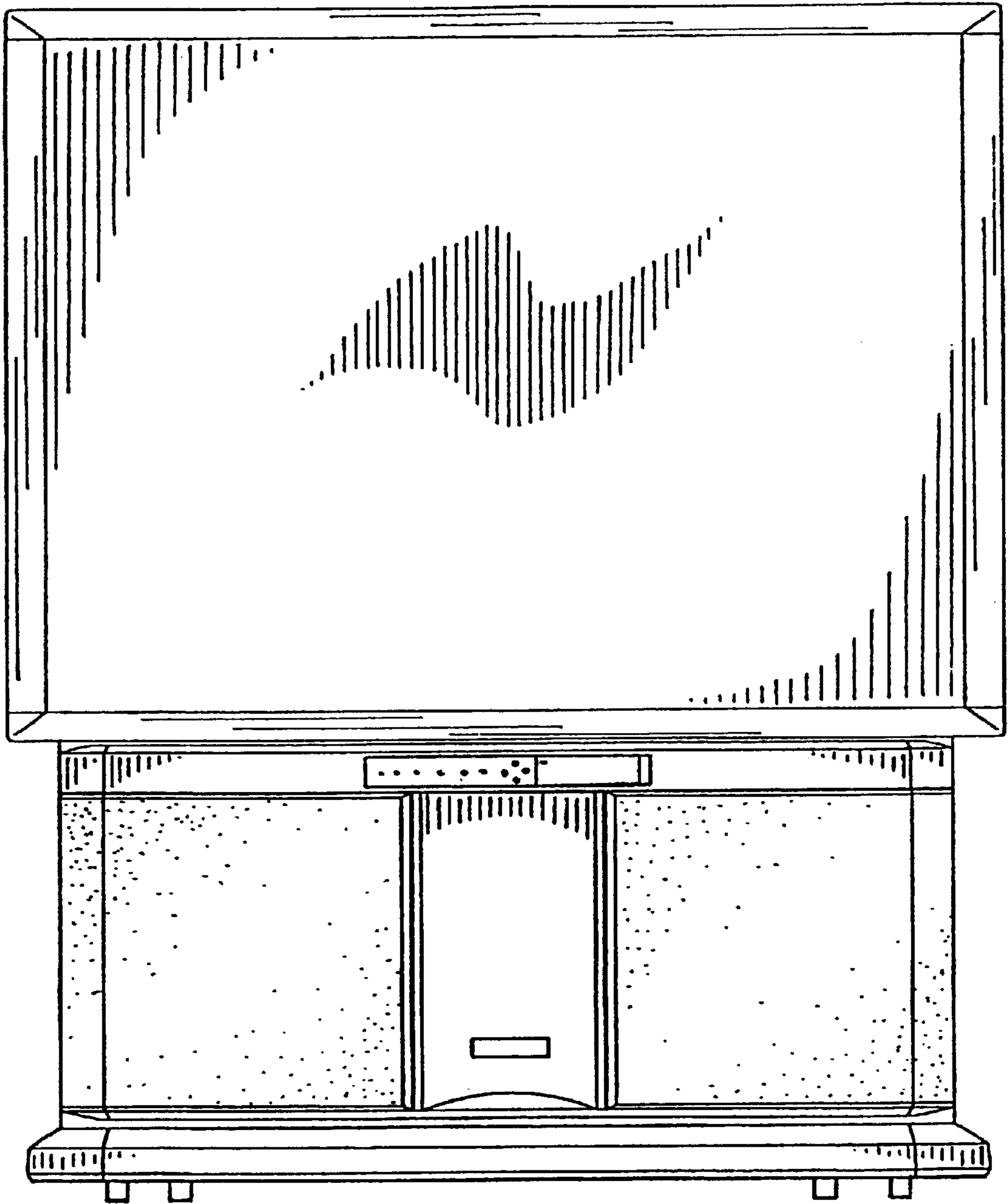

Fig. 2

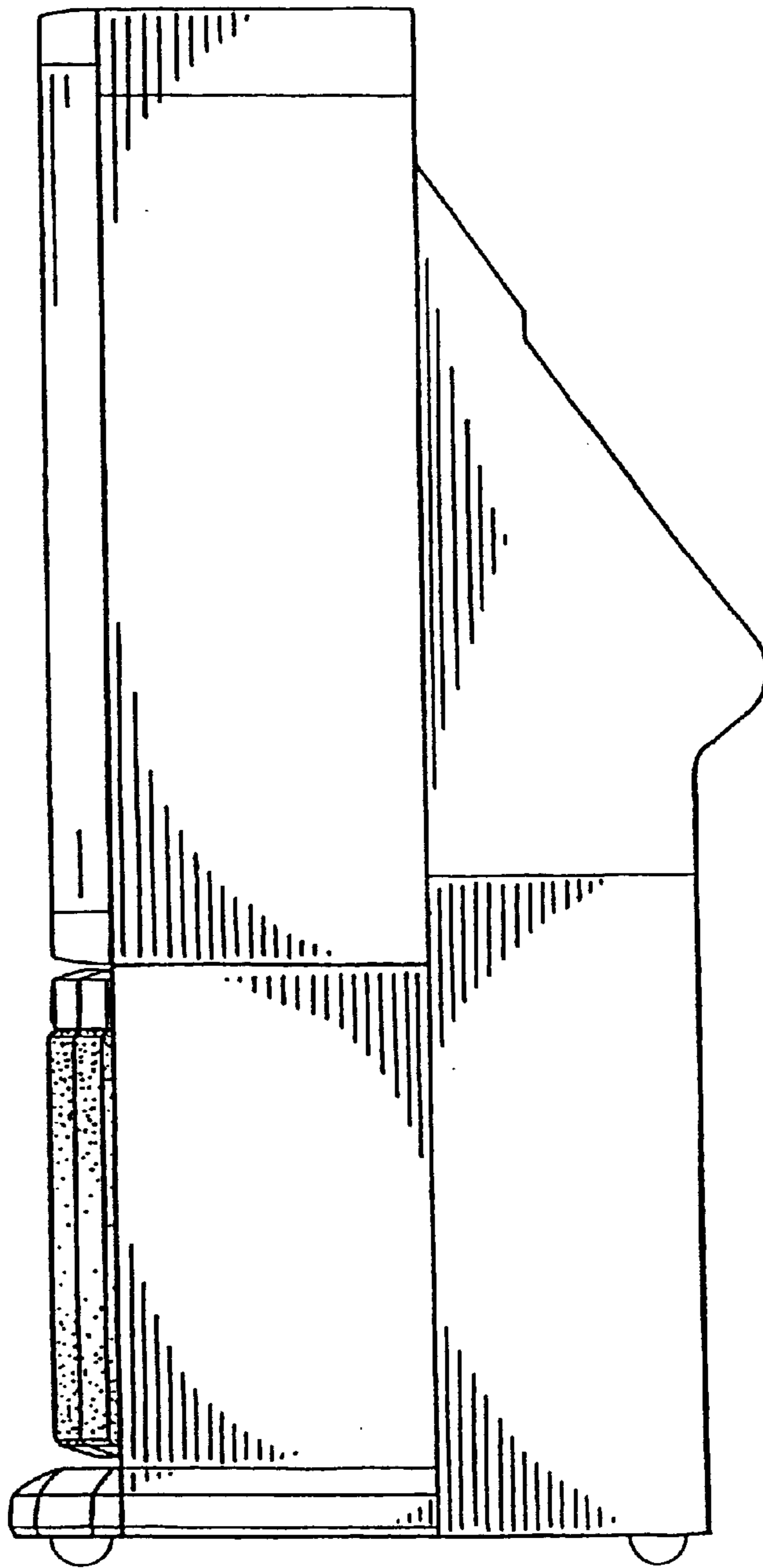

Fig. 3

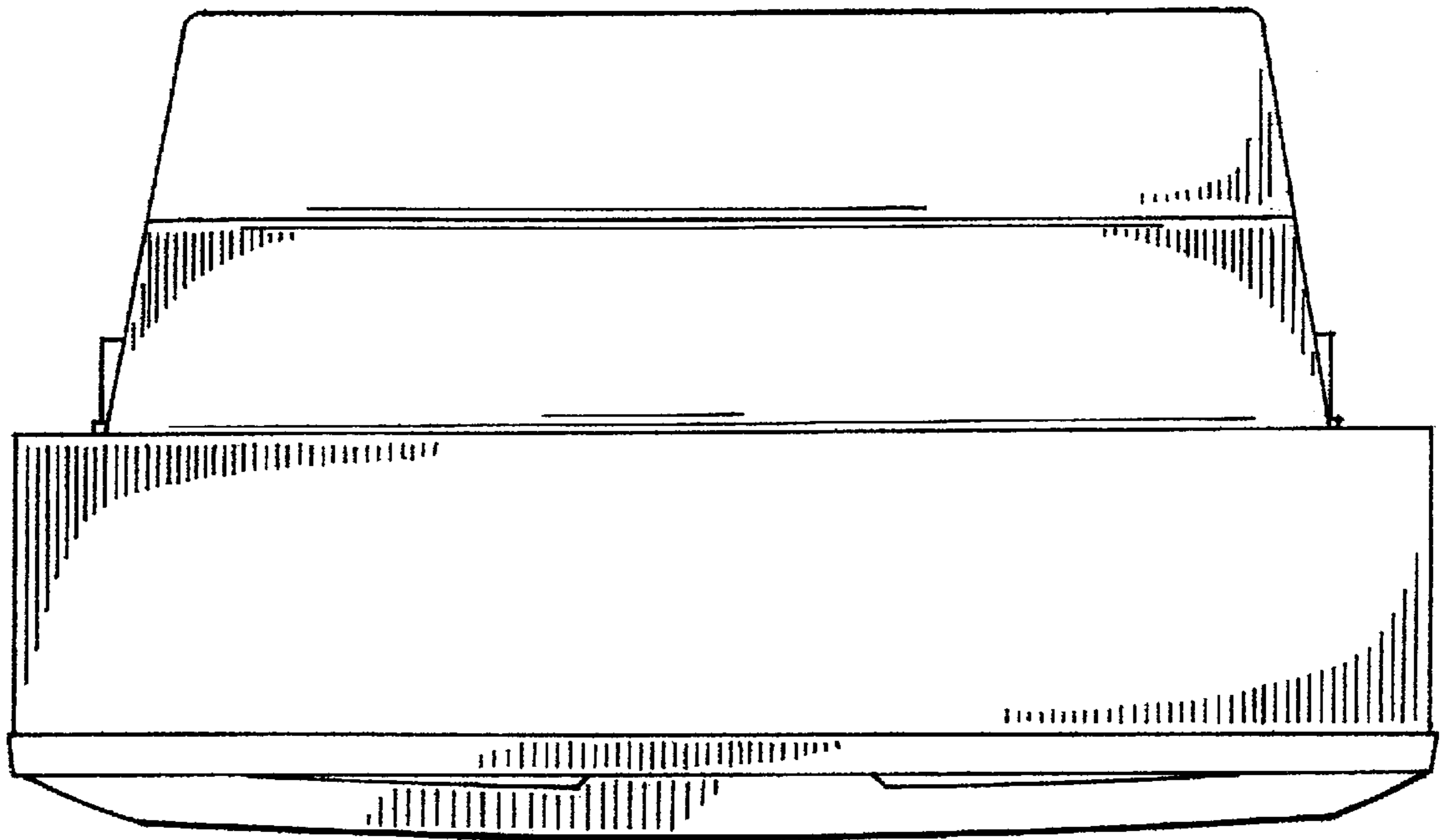

Fig. 4

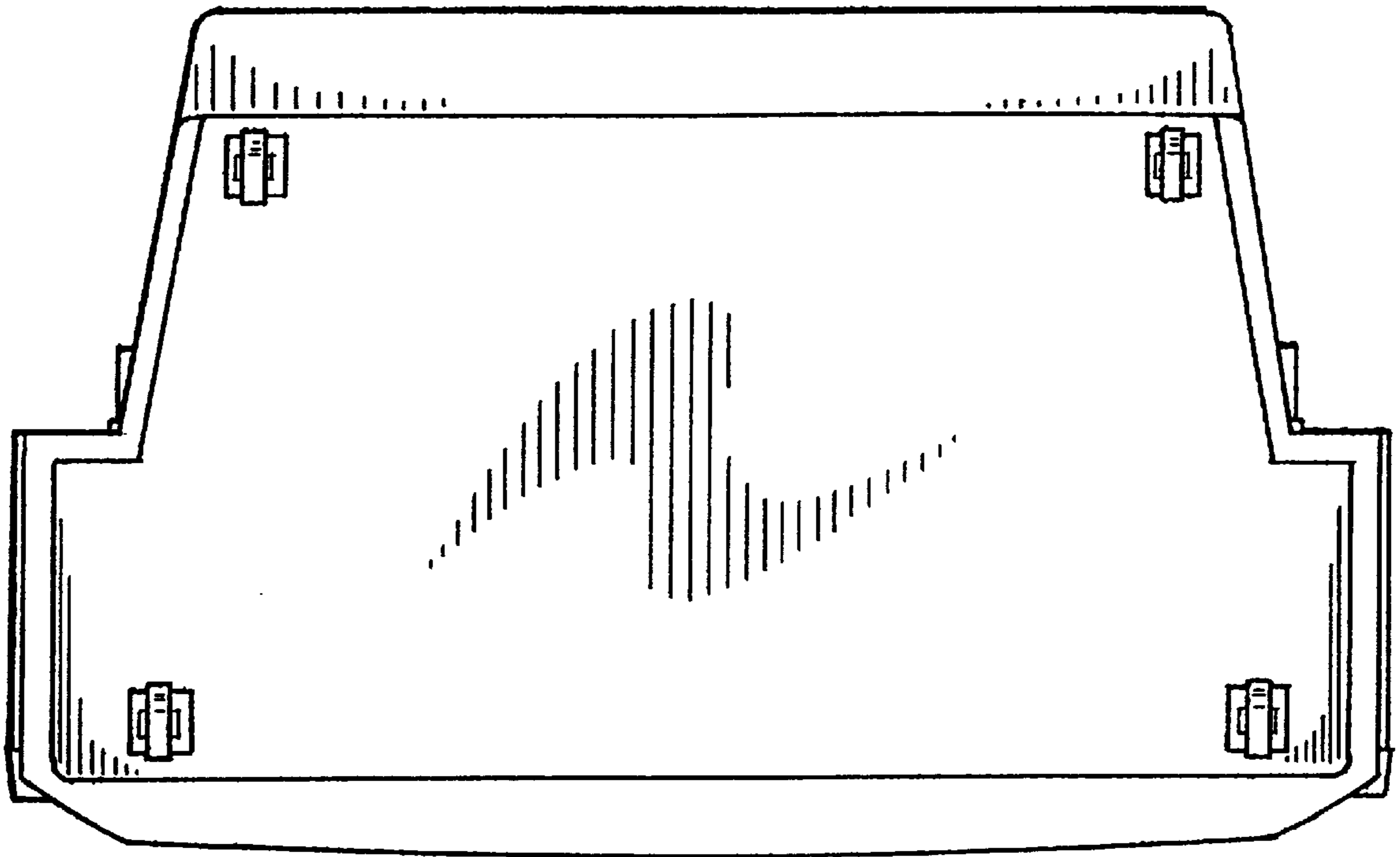

Fig. 5

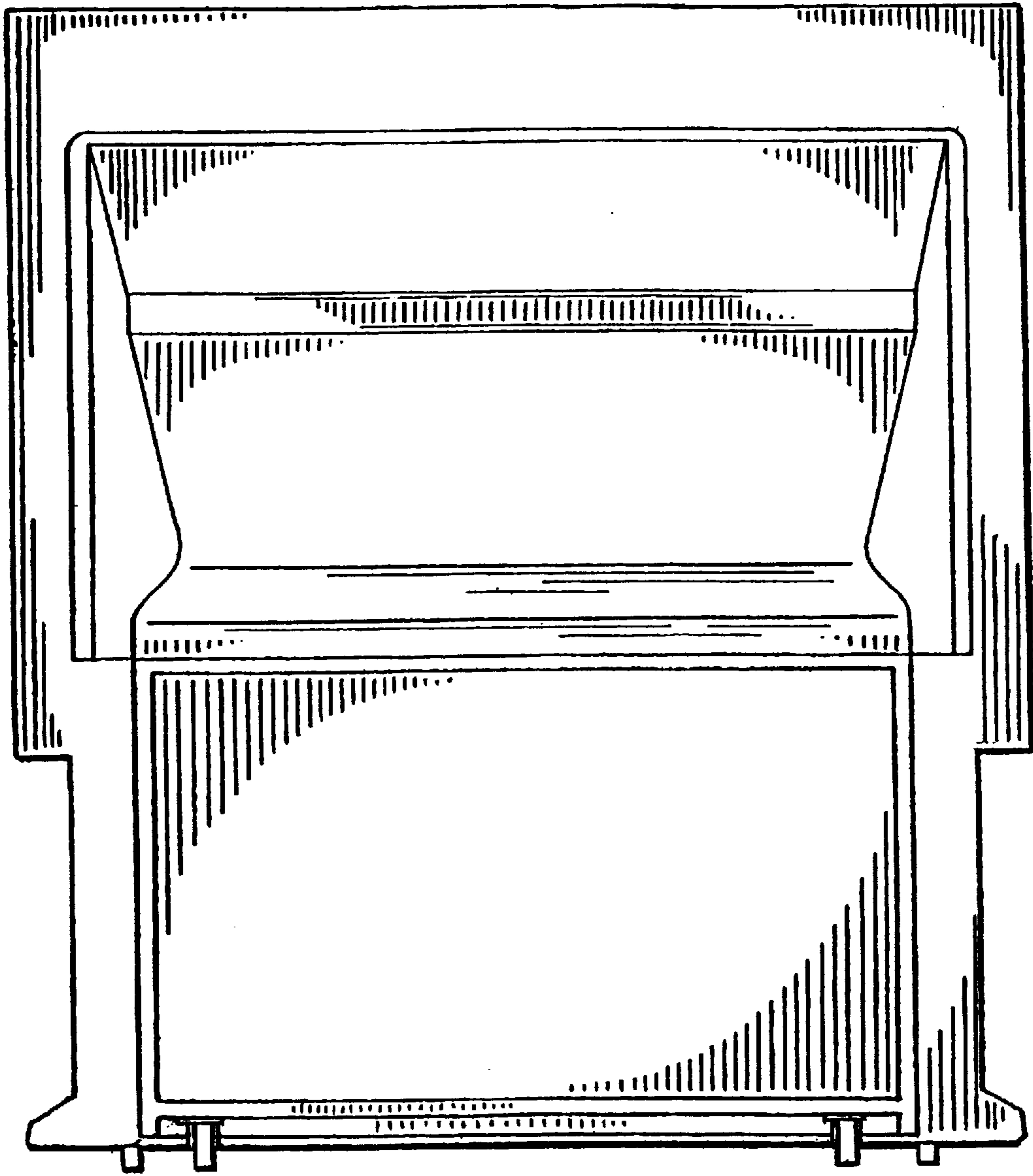

Fig. 6