



US00D433873S

United States Patent [19]
Yu

[11] **Patent Number: Des. 433,873**

[45] **Date of Patent: ** Nov. 21, 2000**

[54] **HANDLE**

[76] Inventor: **Chih-Hsin Yu**, 4F-3, No. 123, Lane 235, Pao Chiao Rd., Hsin Tien City, Taiwan

[**] Term: **14 Years**

[21] Appl. No.: **29/121,478**

[22] Filed: **Apr. 7, 2000**

[51] **LOC (7) Cl.** **07-02**

[52] **U.S. Cl.** **D7/395; D7/393**

[58] **Field of Search** D7/393-395, 401.2, D7/642, 645, 649, 650, 653, 662-664, 688; D8/107; 16/110.1, DIG. 12, DIG. 18, DIG. 19; 30/322, 324; 220/752, 755

[56] **References Cited**

U.S. PATENT DOCUMENTS

D. 422,191 4/2000 Usbeck D8/107

OTHER PUBLICATIONS

Tableware International; p. 22; Pan handle by Risoli's; top of page, Nov. 1996.

Primary Examiner—Caron D. Veynar
Attorney, Agent, or Firm—Bacon & Thomas, PLLC

[57] **CLAIM**

The ornamental design for handle, as shown and described.

DESCRIPTION

FIG. 1 is a perspective view of handle showing my new design.

FIG. 2 is a front elevational view thereof;

FIG. 3 is a rear elevational view thereof;

FIG. 4 is a left side elevational view thereof;

FIG. 5 is a right side elevational view thereof;

FIG. 6 is a top plan view thereof; and,

FIG. 7 is a bottom plan view thereof.

The broken line showings in FIGS. 1-7 are for illustrative purposes only and form no part of the claimed design.

1 Claim, 6 Drawing Sheets

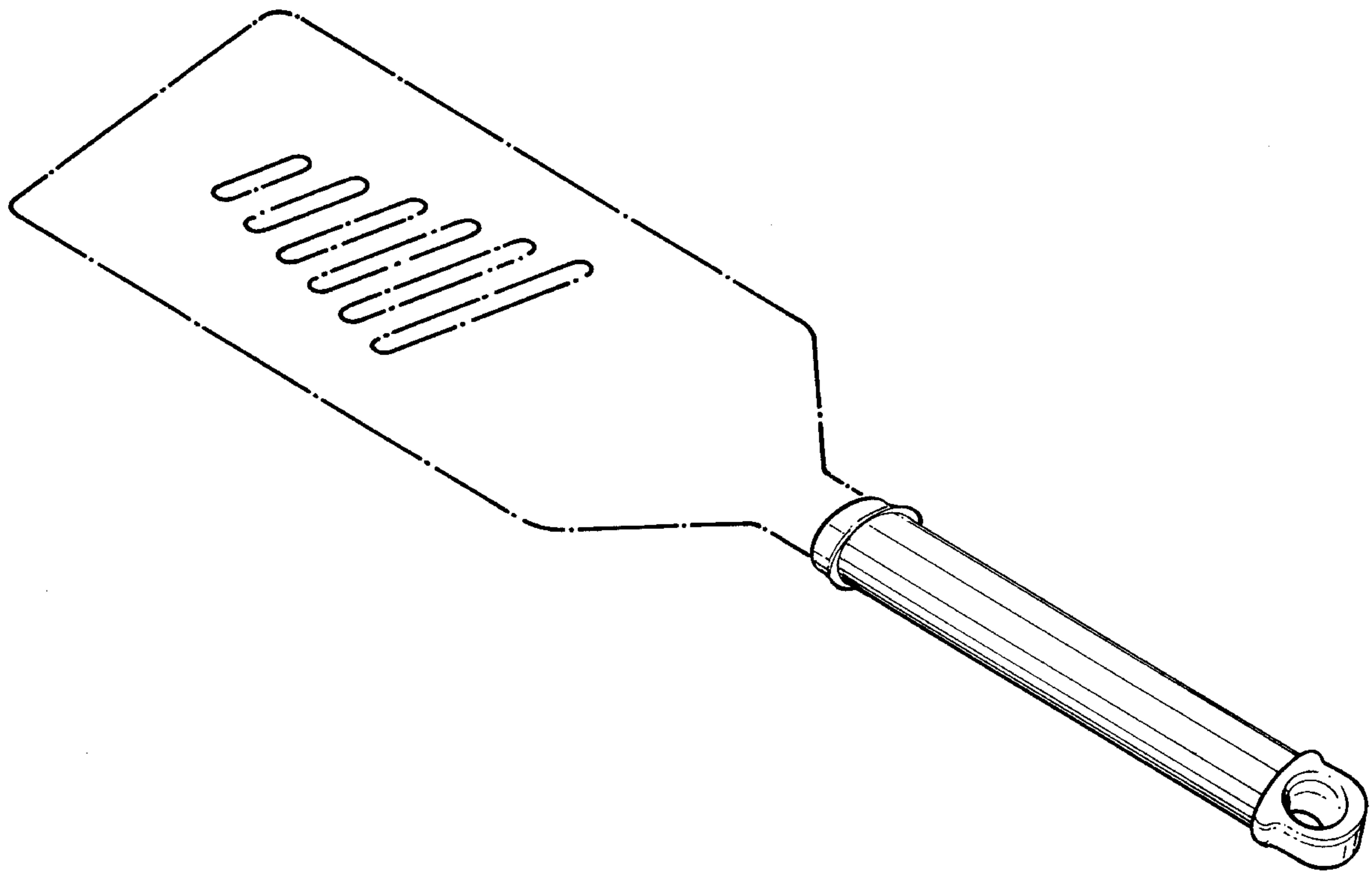

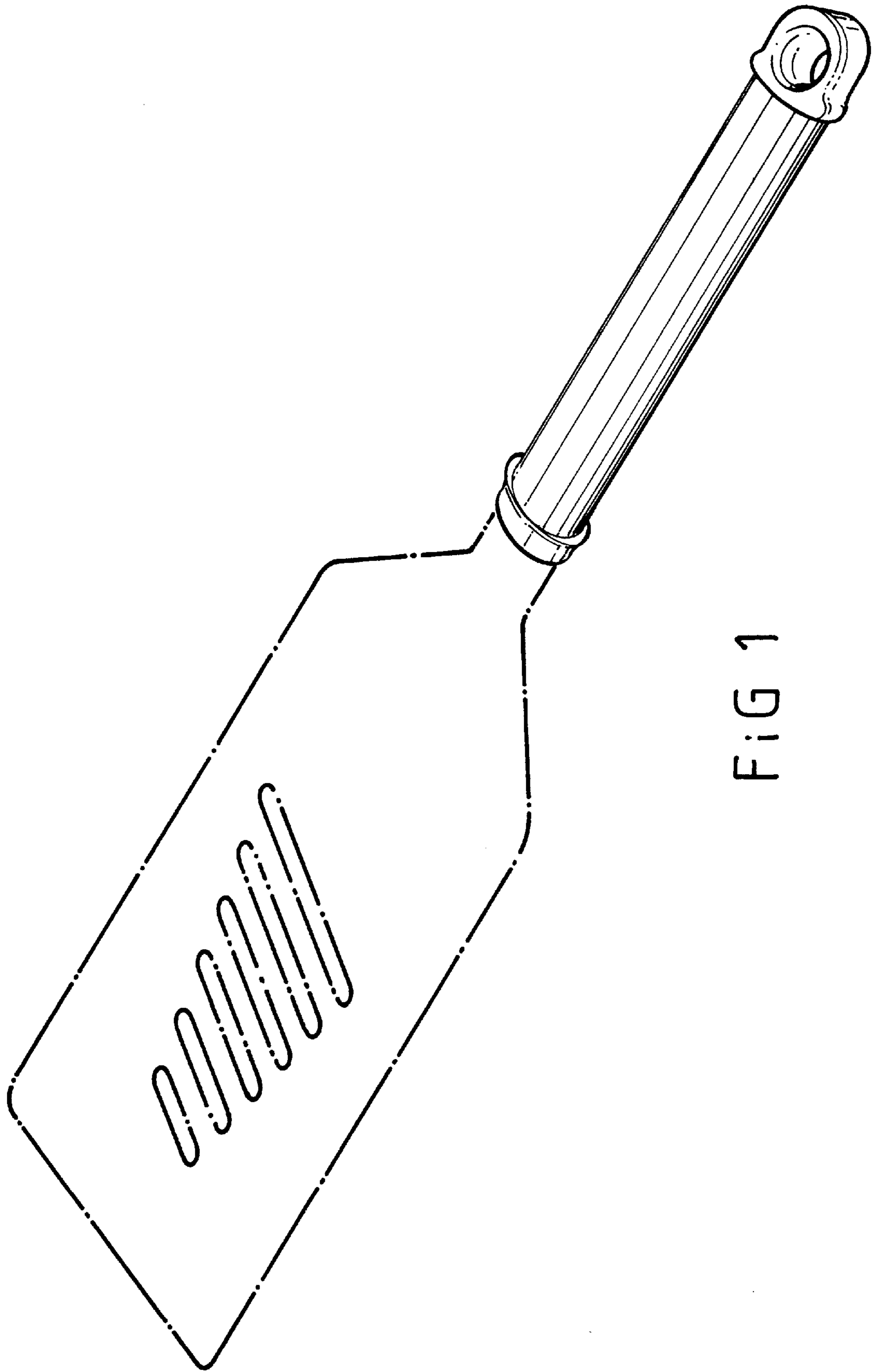

FIG 1

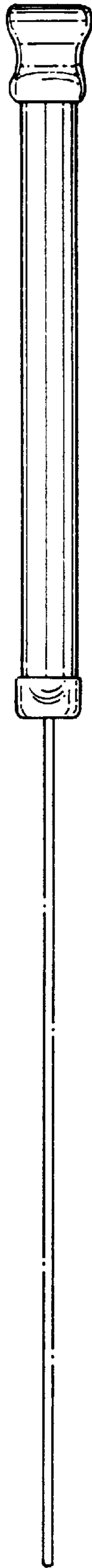

FIG 2

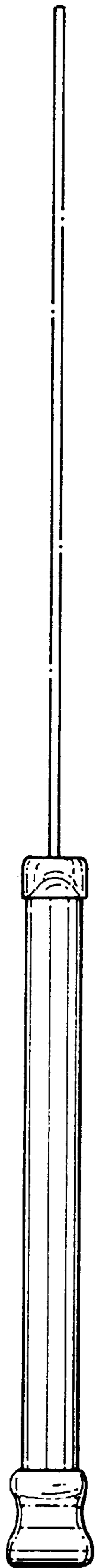

FIG 3

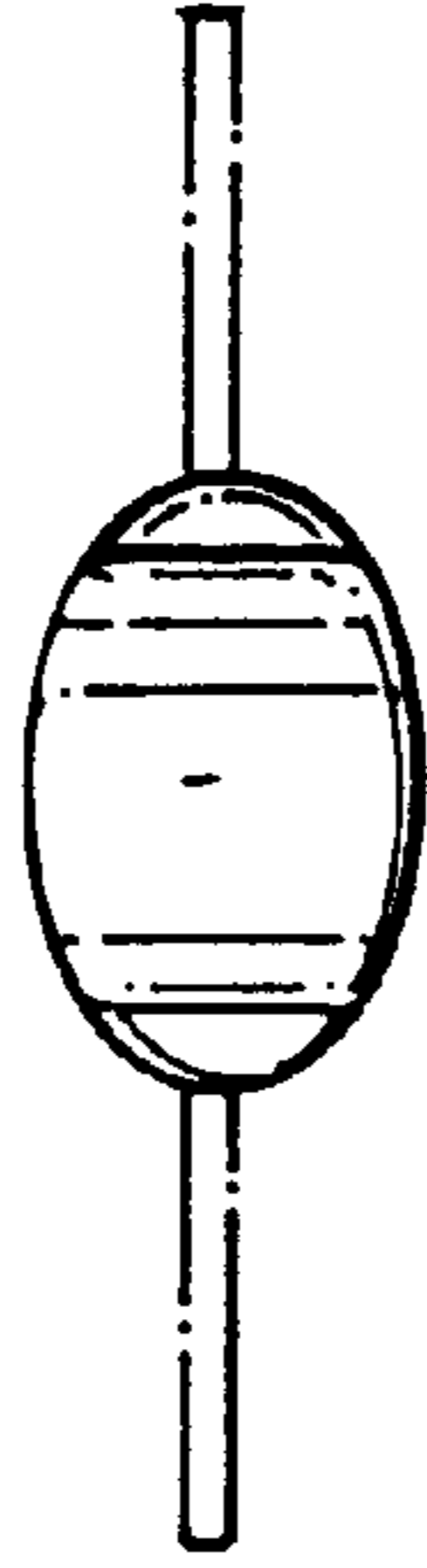

FIG 5

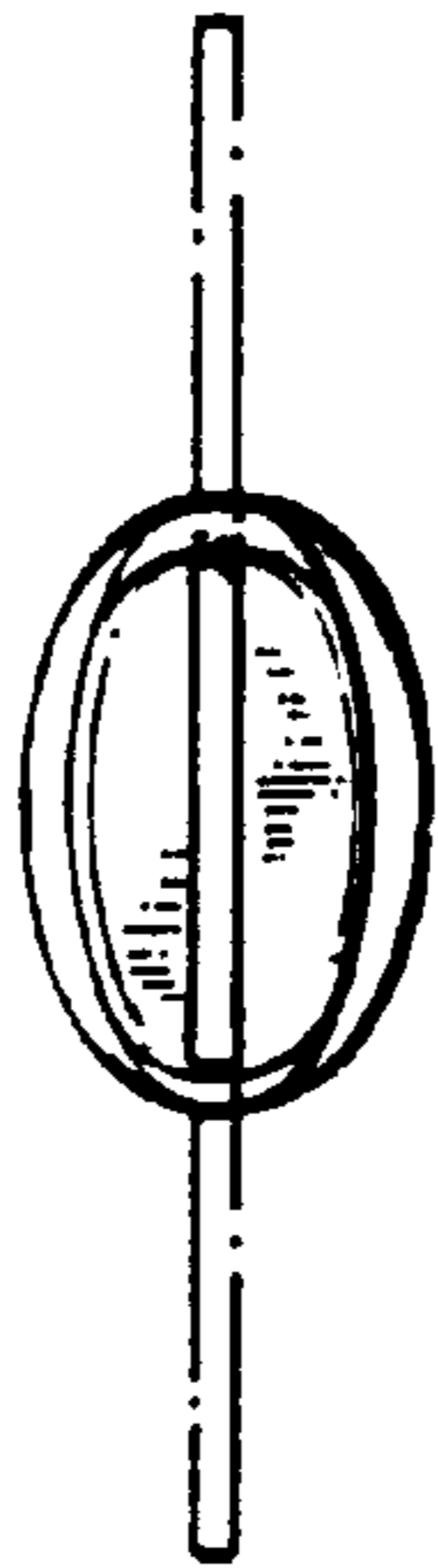

FIG 4

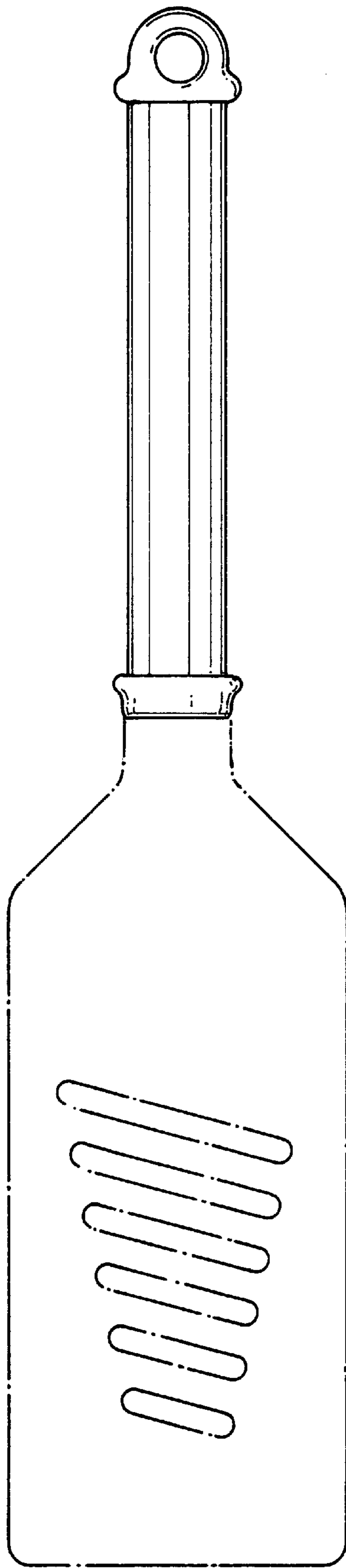

FIG 6

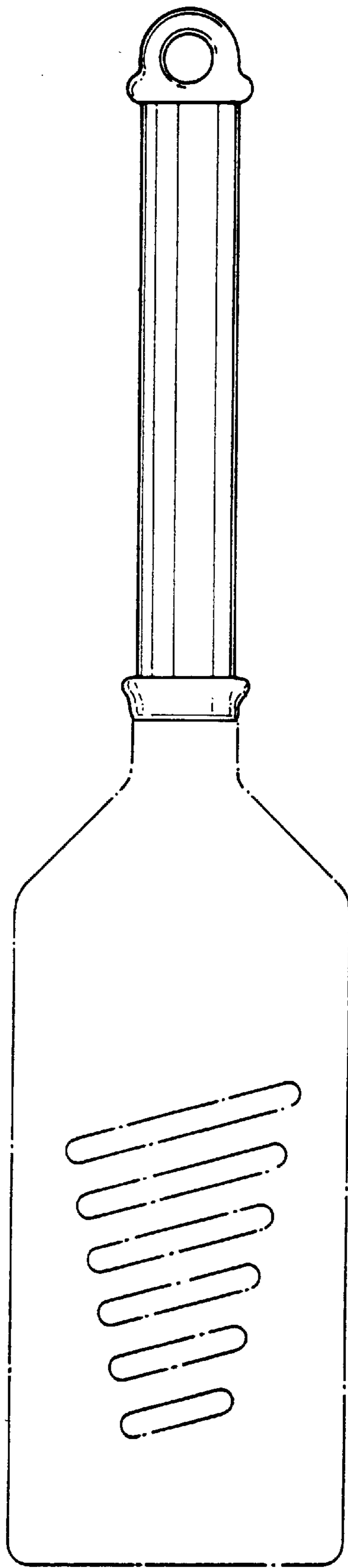

FIG 7