



US00D433759S

# United States Patent [19]

Mathis et al.

[11] Patent Number: **Des. 433,759**

[45] Date of Patent: **\*\* Nov. 14, 2000**

[54] **VIAL CARRIER**

[75] Inventors: **Scott E. Mathis**, Bay Village; **David P. Weber**, Strongsville, both of Ohio

[73] Assignee: **Bayer Corporation**, Tarrytown, N.Y.

[\*\*] Term: **14 Years**

[21] Appl. No.: **29/089,570**

[22] Filed: **Jun. 18, 1998**

[51] **LOC (7) Cl.** ..... **06-04**

[52] **U.S. Cl.** ..... **D24/227; D24/229**

[58] **Field of Search** ..... D24/227, 229,  
D24/230; 422/65, 61, 104; 211/74, 72,  
71, 69

[56] **References Cited**

### U.S. PATENT DOCUMENTS

D. 333,522	2/1993	Gianino	.....	D24/229
D. 359,127	6/1995	Biesecker	.....	D24/227
3,854,602	12/1974	Blank	.....	214/6
3,985,507	10/1976	Litz et al.	.....	23/253
4,040,533	8/1977	DeBoer et al.	.....	214/310
4,454,939	6/1984	Kampf et al.	.....	198/341
4,503,964	3/1985	Kampf et al.	.....	198/341
4,678,752	7/1987	Thorne et al.	.....	435/291
4,861,554	8/1989	Sakuma	.....	422/65
4,944,924	7/1990	Mawhirt et al.	.....	422/104
5,008,082	4/1991	Shaw	.....	422/65
5,098,663	3/1992	Berthold et al.	.....	422/104

5,128,105	7/1992	Berthold et al.	.....	422/104
5,186,339	2/1993	Heissler	.....	211/74
5,224,585	7/1993	Blanco et al.	.....	198/803.01

### FOREIGN PATENT DOCUMENTS

410645A2	1/1991	European Pat. Off.	.....	G01N 35/02
----------	--------	--------------------	-------	------------

### OTHER PUBLICATIONS

Boehringer Mannheim/Hitachi 747-100 Operator's Manual, 1.3 Sample Transport System, pgs. 1-15-1-20 (1992).  
Boehringer Mannheim/Hitachi 747-100 Analyzer Operator's Manual, 5.4 Sample Transport System, pgs. 5-13-5-24 (1992).

*Primary Examiner*—Ian Simmons  
*Attorney, Agent, or Firm*—Weingarten, Schurgin, Gagnebin & Hayes LLP

[57] **CLAIM**

The ornamental design for a vial carrier, as shown.

### DESCRIPTION

FIG. 1 is a front view of a vial carrier according to the presently disclosed invention;  
FIG. 2 is a right-side view of the vial carrier of FIG. 1;  
FIG. 3 is a rear view of the vial carrier of FIG. 1;  
FIG. 4 is a left-side view of the vial carrier of FIG. 1;  
FIG. 5 is a top view of the vial carrier of FIG. 1;  
FIG. 6 is a bottom view of the vial carrier of FIG. 1; and,  
FIG. 7 is a perspective view of the vial carrier of FIG. 1;

**1 Claim, 3 Drawing Sheets**

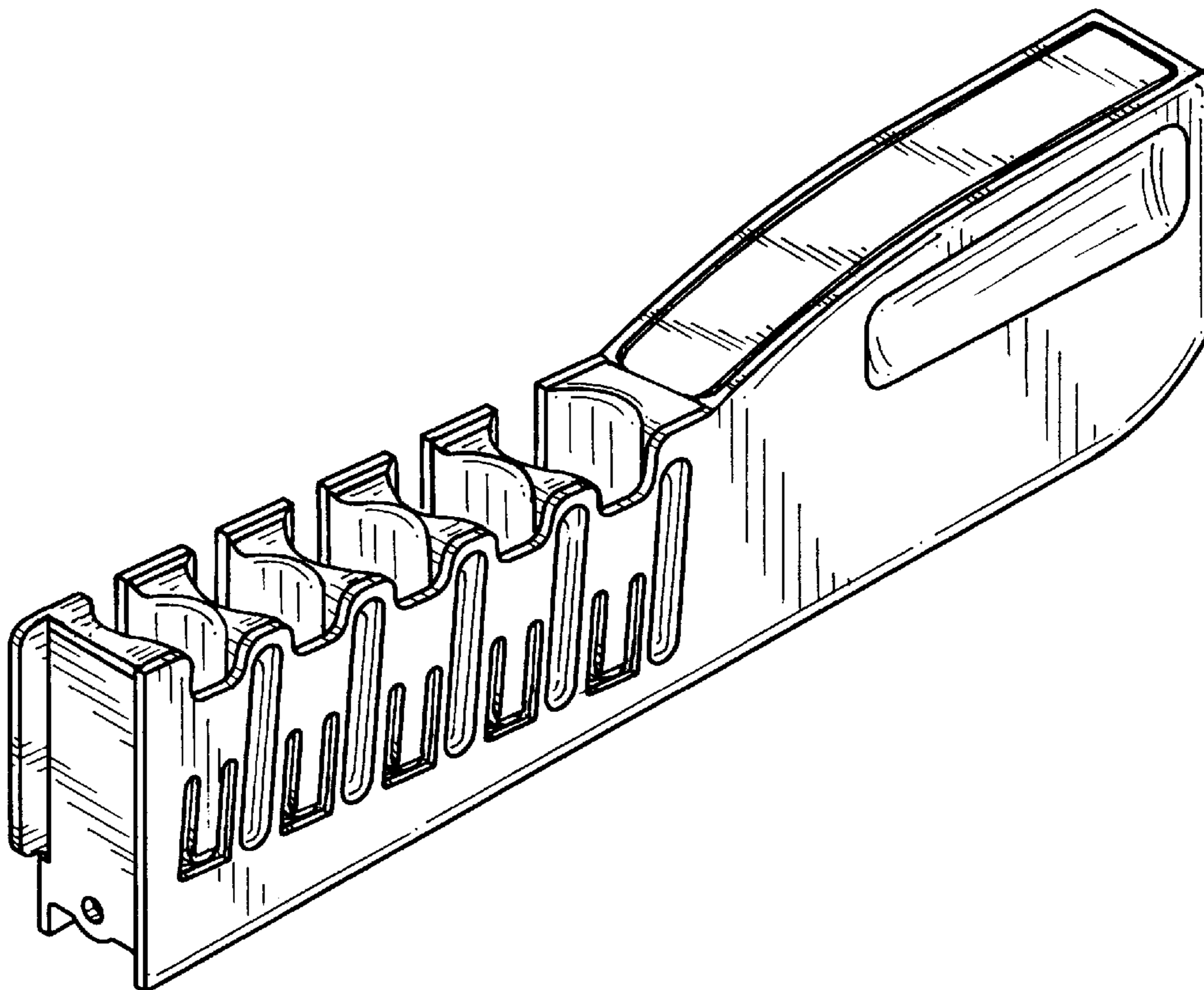

FIG. 1

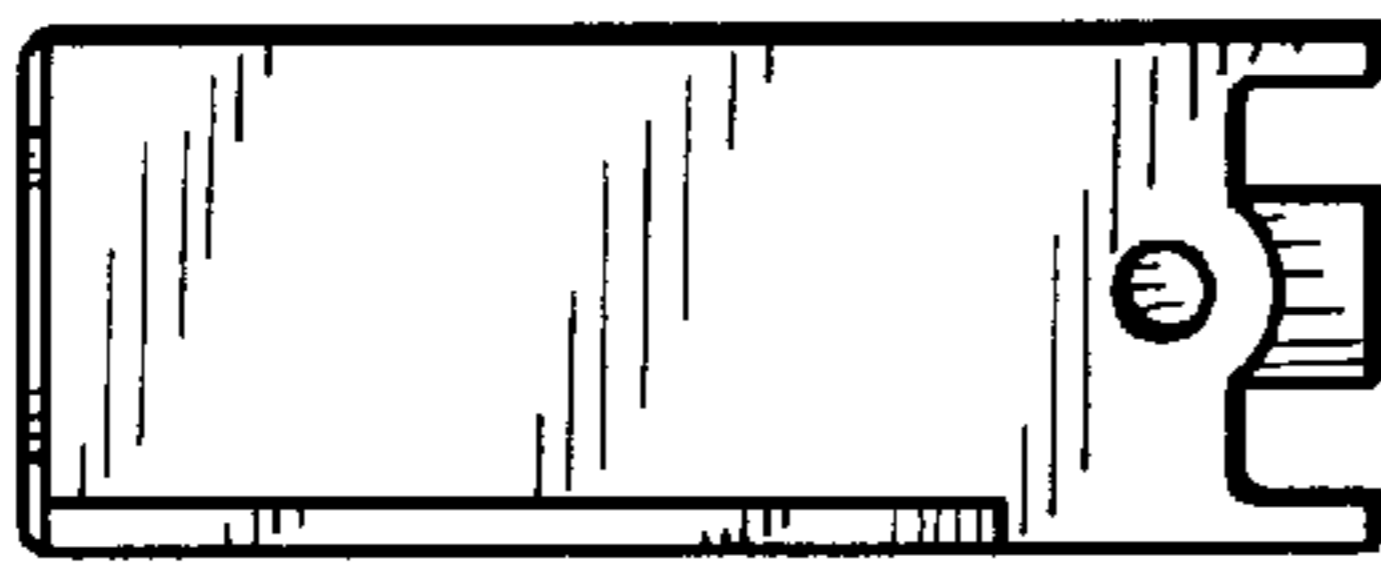

FIG. 2

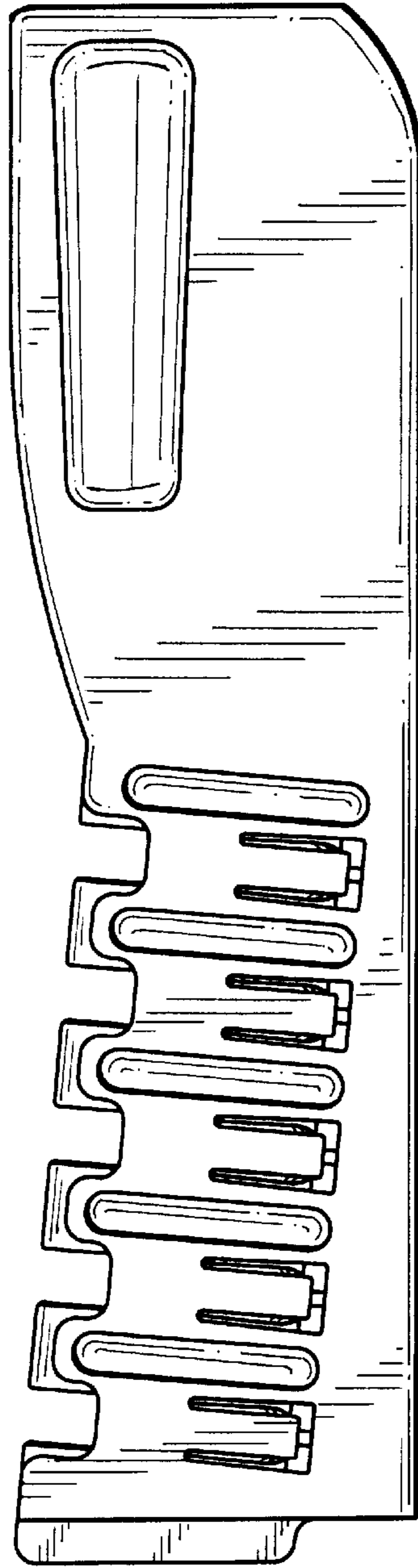

FIG. 3

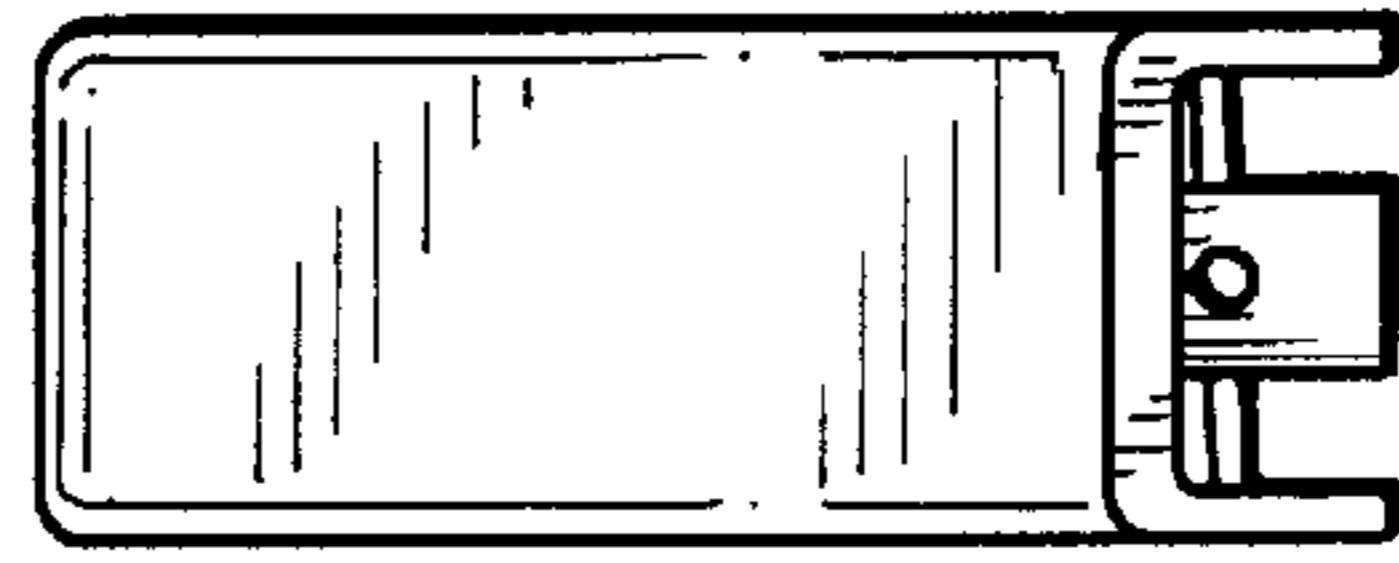

FIG. 4

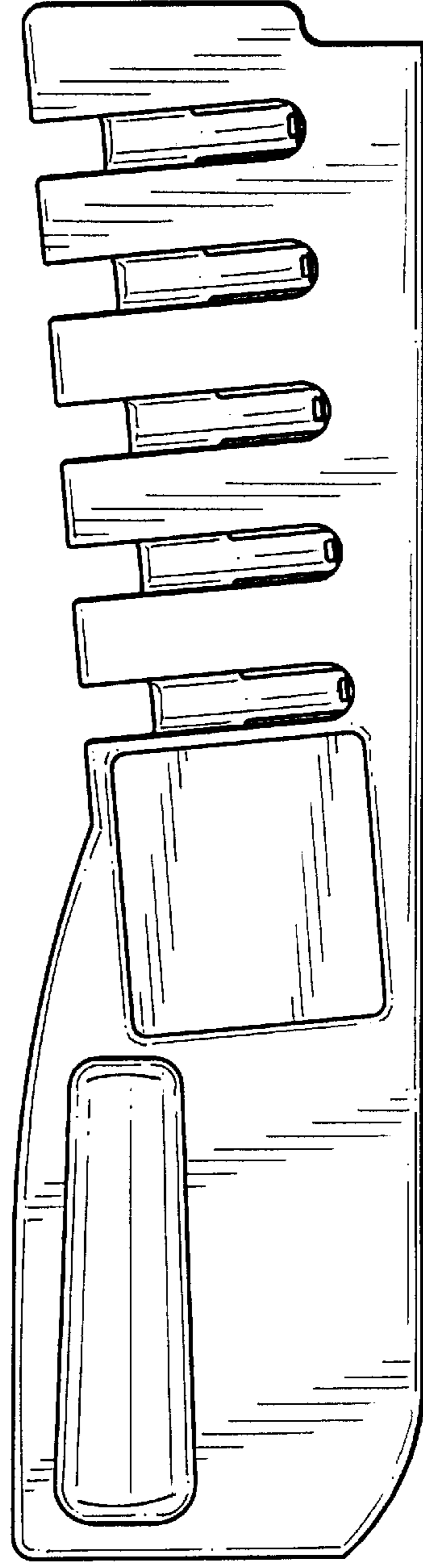

FIG. 5

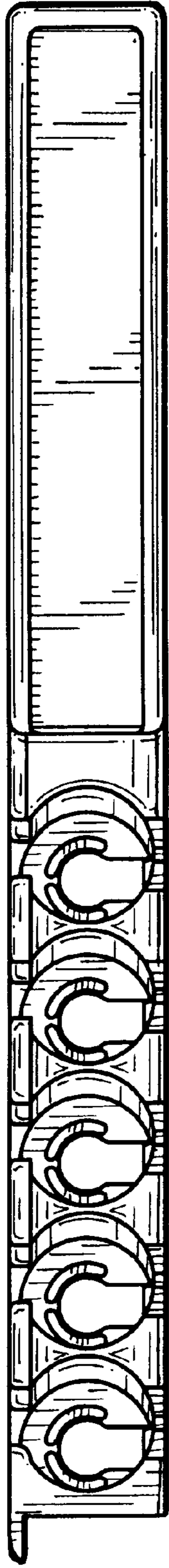
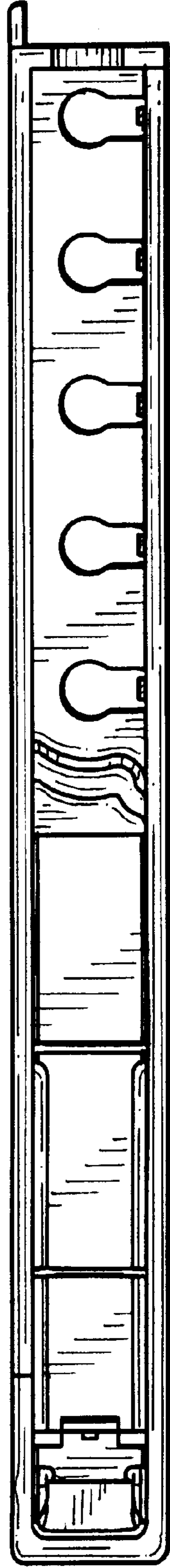

FIG. 6



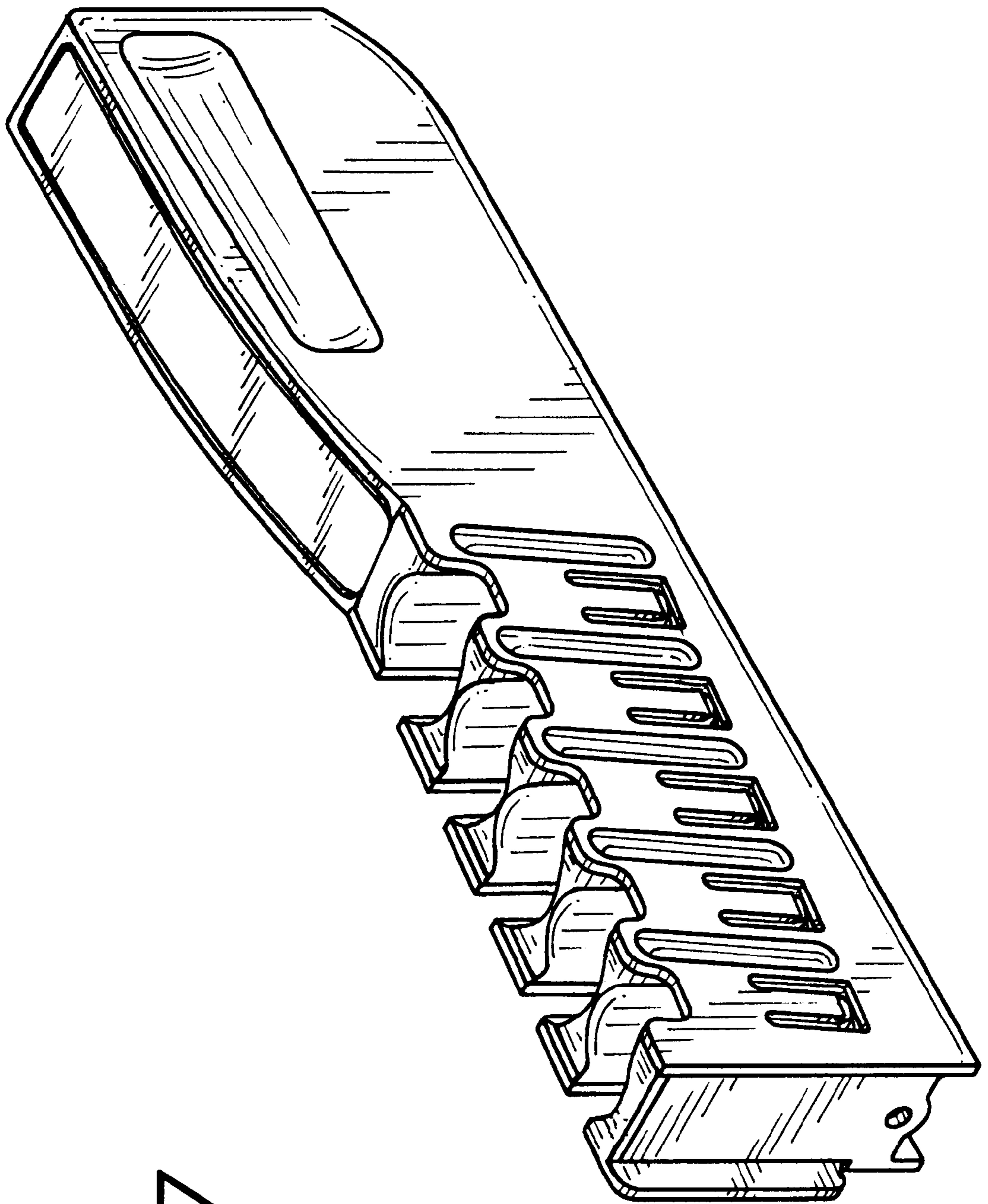

FIG. 7